

Cam Analyzer v4.0 for Windows

Check Appendices 3 - 8 for most recent changes

User's Manual

Performance Trends, Inc.

31531 W Eight Mile Rd Livonia, MI 48152
248-473-9230 Fax 248-442-7750

Website: www.performancetrends.com

Email: feedback@performancetrends.com

Performance Trends, Inc. 31531 W Eight Mile Rd, Livonia, MI 48152
Tech Assistance for Registered Owners (248) 473-9230 Fax: 248-442-7750 Email: feedback@performancetrends.com

Website (tips, correspond with other users, download demos, update schedule, etc.) www.performancetrends.com

Copyright Notice

Copyright (C) 2012 PERFORMANCE TRENDS, INC. All Rights Reserved

These software programs and user's manual are reserved by PERFORMANCE TRENDS, INC. and are intended for the use of the original owner only. Copying or duplicating these products except for the personal use of the original owner is a violation of U. S. Copyright Law and is hereby expressly forbidden.

Portions Copyright (C) Microsoft Corp. 1982-2012 All Rights Reserved

International Business Machines Corp. makes no warranties, either expressed or implied, regarding the enclosed computer package, its merchantability or its fitness for any particular purpose.

IBM PC, XT, and AT are registered trademarks of International Business Machines Corp.
Windows is a registered trademark of Microsoft Corp.
Cam Dr is a trademark of Quadrant Scientific.
Cam Pro Plus is a trademark of Audie Technology.
Competition Cams is a trademark of Competition Cams Inc.
UltraDyne is a trademark of Ultra Dyne Corporation

DISCLAIMER OF WARRANTIES:

THE SOFTWARE PROVIDED HEREUNDER IS LICENSED "AS IS" WITHOUT ANY WARRANTIES, EXPRESS OR IMPLIED, INCLUDING BUT NOT LIMITED TO, ANY WARRANTIES FOR MERCHANTABILITY OR FITNESS FOR A PARTICULAR PURPOSE. NO ORAL OR WRITTEN STATEMENTS, REPRESENTATIONS OR OTHER AFFIRMATION OF FACT, INCLUDING BUT NOT LIMITED TO STATEMENTS REGARDING CAPABILITY, CAPACITY, SUITABILITY FOR USE OR PERFORMANCE OF SOFTWARE SHALL BE RELIED UPON BY USER OR BE DEEMED TO BE A WARRANTY OR REPRESENTATION BY PERFORMANCE TRENDS, INC. FOR ANY PURPOSE, OR GIVE RISE TO ANY LIABILITY OF OBLIGATION OF PERFORMANCE TRENDS, INC. WHATSOEVER. USER ACCEPTS ALL RESPONSIBILITY FOR SELECTING THE SOFTWARE TO MEET USER NEEDS OR SPECIFIC PURPOSES. PERFORMANCE TRENDS INC. IS UNDER NO OBLIGATION TO FURNISH USER UPDATES OR ENHANCEMENTS EVEN IF FURNISHED TO OTHER USERS.

LIMITATION OF LIABILITY:

If at the time of delivery to the original User only there are any defects in the media on which the Software is provided, User's sole and exclusive remedy shall be the replacement of any media returned to Performance Trends, Inc. within 90 days of the receipt of the Software by User, or at Performance Trends Inc.'s sole option, a refund of the License fees paid to Performance Trends, Inc. by User.

IN NO EVENT SHALL PERFORMANCE TRENDS, INC. OR THIRD PARTIES WHO HAVE RIGHTS IN THE SOFTWARE BE LIABLE TO USER FOR LOSS OF PROFITS, INDIRECT, SPECIAL, INCIDENTAL OR

CONSEQUENTIAL DAMAGES EVEN IF PERFORMANCE TRENDS, INC. IS AWARE OF THE POSSIBILITY OF SUCH DAMAGES.

Continued on next page.

IN THE EVENT ANY REMEDY HEREUNDER FAILS OF ITS ESSENTIAL PURPOSE, OR IN ANY OTHER EVENT, PERFORMANCE TRENDS INC.'S LIABILITY HEREUNDER SHALL NOT EXCEED ANY AMOUNTS PAID BY USER TO PERFORMANCE TRENDS, INC. UNDER THIS AGREEMENT.

Some states do not allow the limitation or exclusion of liability for incidental or consequential damages and some states do not allow the exclusion of implied warranties, so the above limitations or exclusions may not apply to you.

No action, regardless of form, arising out of any claimed breach of this agreement or performance under this agreement may be brought by either party more than one year after the affected party learns of the cause of action.

Refer to diskette envelope for full license agreement.

***** W A R N I N G *****

The Cam Analyzer makes calculations based on equations and data found in various published and heretofore reliable documents. The program is designed for use by skilled professionals experienced with engines and Tests. The following processes are hazardous, particularly if done by an unskilled or inexperienced user:

- Obtaining data to input to the program
- Interpreting the program's results

Before making measurements of or modifications to any Test, engine or driving situation, DO NOT FAIL TO:

- Regard the safety consequences
- Consult with a skilled and cautious professional
- Read the entire user's manual
- Obey all federal, state & local laws
- Respect the rights and safety of others

Table of Contents

Chapter 1 Introduction	1
1.1 Overview of Features	1
1.2 Before You Start	2
1.3 A Word of Caution	3
1.4 Getting Started (Installation)	4
1.5 Example to Get You Going	5
Chapter 2 Definitions	9
2.0 Basic Program Operation	9
2.1 Main Screen (cam data input)	13
2.2 Preferences	19
2.3 Test Setup and Cam Specs	21
2.4 Find TDC	27
2.5 Generate Degree Wheel Readings	33
2.6 New Test Screen	35
2.7 EZ Data Entry	37
Chapter 3 Output	39
3.1 Reports	41
3.2 ASCII Data Files (Pro version only)	49
3.3 Graphs	51
3.4 Printer Output	63
3.5 Data Libraries	67
3.6 Opening Other Cam File Formats	71
3.7 History Log	75
3.8 Create Cam Dr File	77

Table of Contents, cont

Chapter 4 Examples	79
Example 4.1 Running A Cam Test By Entering Cam Lift Measurements Directly Into The Computer, With TDC Procedure	81
Example 4.2 Comparing and Analyzing Cams	93
Appendix 1: Accuracy and Assumptions	99
Appendix 2: Backing Up Data	107
Appendix 3: New Features for Version 3.2	111
Appendix 4: New Features for Version 3.2B (Cam Test Stand Electronics)	117
Appendix 5: New Features for Version 3.8	137
Appendix 6: New Features for Version 4.0	159
Appendix 7: FFT Analysis in v4.0	181
Appendix 8: Filter Test Files (Plus Version Only)	183
Index	187

Chapter 1 Introduction

1.1 Overview of Features

The Cam Analyzer program by Performance Trends Inc. is a computer program to help engine builders check their camshafts for accuracy and proper installation. The program offers options to record, save, graph, organize, open (retrieve), report and analyze cam lift data recorded from dial indicator and degree wheel data. In addition, cam profile data can be written to a Cam Dr (tm) file for use in our Engine Analyzer' Pro' program for detailed engine performance and valve train dynamics simulation. The Cam Analyzer v2.0 is a unique program which will save cam time and improve the analysis of cam profile cam data.

New features in v2.0 include:

- User friendly, Windows interface, compatible with Windows 3.1, 95, 98, 2000 and NT (and later for XP, Vista and Windows 7).
- Can print results using most any Windows compatible printer, many times in color.
- Reads cam files from several other cam programs, like Cam Dr, Cam Pro Plus, Doctor Dr, etc. This one program can let you compare cam data from several sources.
- Generate cam profiles from simple inputs like duration at .050" lift, centerline and maximum tappet lift.
- Save nearly unlimited number of cams for recall, comparison and analysis in the future.
- Find TDC following a step-by-step procedure. This procedure's results can be printed separately as a data sheet, very handy for engine builders.
- Allows several reporting and graphing options for analysis.
- Ability to write ASCII files for importing data into other computer programs.
- "History Log", keeps a running log of cams you have recently started new, run, graphed or reported.

Please read Sections 1.2 "Before You Start" and 1.3 "A Word of Caution" before you turn on the computer. Then try running the program following the guidelines in 1.4 "Getting Started" and 1.5 "Example to Get You Going". When you feel a little familiar with the program, take time to read this entire manual. It will show you all the things you can do with this powerful tool.

We are constantly enhancing and advancing this cam measurement and analysis program. We now have our electronic Cam Test Stand (for fast and precise "on stand" or "in engine" cam measurements) and are up to Version 4.0. Appendices 3 - 8 cover all the features we've added and have GREATLY enhanced on this program since this manual was originally written. Please be sure to read them also.

1.2 Before You Start

What you will need:

- Most any computer running Windows 98, ME, XP, 2000, NT, Vista, Windows 7.
- Approximately 20 Megabyte of disk space. (More is required for storing large #s of tests.)

Many terms used by the Cam Analyzer and this user's manual are similar to terms used by other publications, i.e. Duration, Lobe Lift, Lobe Area, etc. However, these terms may have different definitions. Therefore, read Chapter 2 to see what these terms mean to the Cam Analyzer.

Occasionally it will be necessary to identify "typos" in the manual, known "bugs" and their "fixes", etc. which were not known at the time of publication. These will be identified in a file called README.DOC in the Cam Analyzer directory or folder.

To read this file, use Windows Explorer to find the Cam Analyzer directory, usually CA20 under PERFRTRNS.PTI. Then double click on README.DOC. Wordpad will display the contents. This file can also be displayed right in the Cam Analyzer by clicking on Help at the Main Screen, then clicking on Display Readme.doc File.

Version 3.8 and later installs to the *C:\Program Files\Performance Trends\Cam Analyzer v3.8* (sometimes *C:\Program Files(x86)\Performance Trends\Cam Analyzer v3.8*) folder.

1.3 A Word of Caution

This program or manual may make reference to how a particular type of cam may perform in an engine. These references can be used to judge cam specs, cam profile modifications, etc. However, an engine is a very complex system, which makes exact suggestions or recommendations about all details impossible. Therefore, the user must recognize:

The software cannot predict the safety of an engine modification or running condition. Please read and follow any safety precautions as described in this manual. Also, get "expert" opinions before running your engine at an RPM or torque level higher than what it was originally designed for.

The software cannot make exact predictions because:

- Much of the input data to the software are estimated.
- Even if the input data were exactly correct, the simplifying assumptions will limit the accuracy.
- Environmental and engine conditions, fuel, the driving situation, etc. are never constant and repeatable.

The software should be used as a guide to:

- Help understand cam profile measurements; what parameters are important and what are the tradeoffs.
- Provide general direction for making modifications. This direction should be verified by other sources like known authorities, engine and cam books, etc. Never trust one "single source" if it does not make sense.
- Make you think, not think for you. If unexpected results are obtained, take a minute to:
 - Double check all input data.
 - Refer back to this manual.
 - Ask someone else skilled and experienced in the particular area.
 - Give the retailer or Performance Trends Inc's. Tech Help Line a call for an explanation. (Also, programs are written by people so it's always possible there may be an error in the calculations. Your call may help us correct it.)

Please also read the Warranty and Warning at the beginning of this manual and on the diskette envelope.

1.4 Getting Started (Installation)

You must install the Cam Analyzer from the distribution CD to a hard drive before it will run. To do this, simply install the CD in your CD Rom drive and the Performance Trends Installation Wizard should automatically start, allowing you to install the Cam Analyzer and demos of any of our other products.

If the CD does not auto-run, then click on Start, then Run, then Browse and find your CD drive. Then look for SETUP.EXE on the CD and run it to run the Installation Wizard. If you want to bypass the Wizard, go into the Programs folder on the CD and run the **Cam Analyzer v4.0 Installer.exe** file.

Figure 1.1 Installation Wizard or Bypassing Installation Wizard

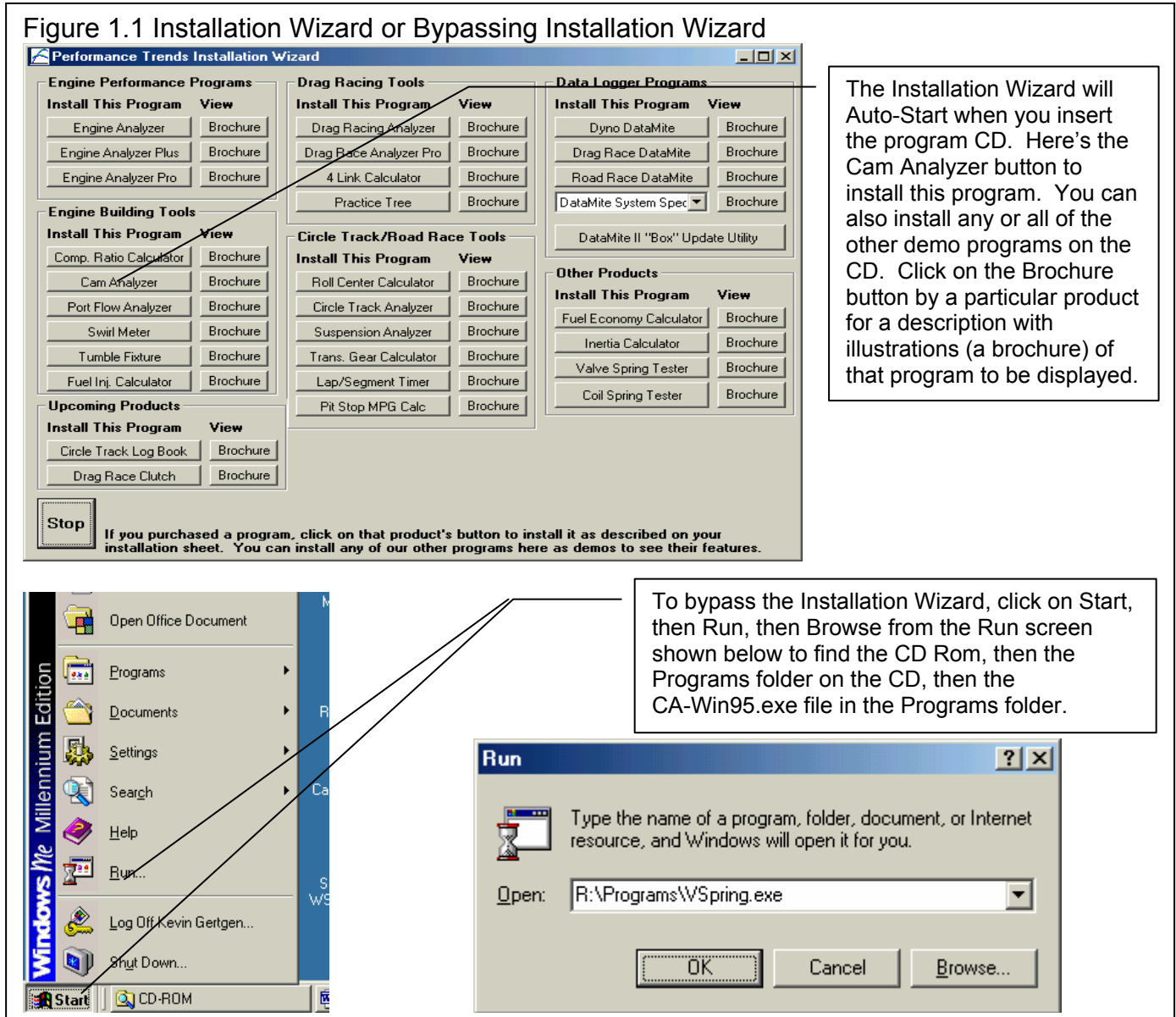

The first time you run the Cam Analyzer, you will be asked to enter your name as the Registered Owner. During this first session, you can modify it until you are satisfied. Once you accept the name, the computer will generate a Registered Code # based on the name. To be eligible for Tech Help, you will need both your registered name and code #, and to have sent in your registration card. The name you enter should be very similar to the name you enter on the registration card. Click on Help, then About Cam Analyzer at the Main Screen to review your name and code #.

1.5 Example to Get You Going

To start the Cam Analyzer, click on Start, then Programs, then Performance Trends, and then Cam Analyzer. Or just click on the Desktop Icon for Cam Analyzer. During startup of the program, you will be given some introductory tips.

One of these “Tips” will ask if the “last cam you were running should be loaded”. If you have just received the program, this cam will be an example cam which was loaded at the factory. If you have run the Cam Analyzer before, this will be the last cam you were working with. If you are just learning the program, it is recommended you answer yes to this question so you have some example data to work with to understand how the program works.

After these brief introduction screens and questions, you will be left at the Main Screen shown below:

Figure 1.1 Introductory Question

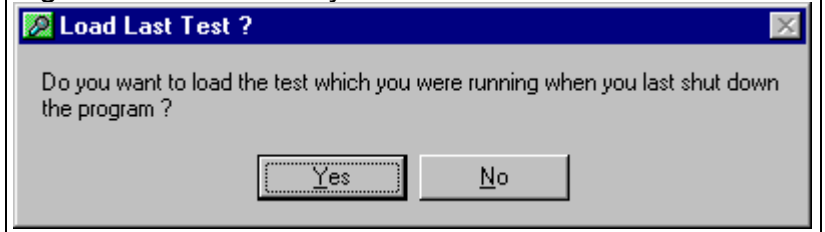

Figure 1.2 Main Screen

The screenshot shows the main interface of Cam Analyzer v2.0. The title bar reads "Cam Analyzer v2.0 Performance Trends [XDRAG.PTI]". The menu bar includes "File", "Graphs", "Reports", "Test Setup & Cam Specs", "Find TDC", "Preferences", and "Help". The "File" menu is open, showing options like "New (start new test)", "Open (from all saved tests)", "Save", "Exit Program", etc. The main area displays "Exhaust #2" and "Test Comments" with a text box containing "Example of Drag Race Roller Cam". Below this is a graph with two curves (grey and blue) plotted against a degree wheel. Annotations on the right side point to the title bar, the menu, and the graph area.

Name of current test you are working with

Menu Commands

Click on File, then choose from different Save or

5	65. BTDC	.014
6	60. BTDC	.018
7	55. BTDC	.022
8	50. BTDC	.028
9	45. BTDC	.035
10	40. BTDC	.043
11	35. BTDC	.052
12	30. BTDC	.064

From this Main Screen, you can:

- Choose to review your options by clicking on the menu items at the top of the screen.
- Open or save a file of cam results and specs by clicking on File in the upper left corner, and then the Open or Save commands.
- Add, edit or review cam data or cam comments for the file you are currently working with.
- Graph or Report the cam for the file you are currently working with.
- Change the Preferences options to somewhat customize the program for your needs.
- Get HELP to explain these options by clicking on Help.
- Quit the program by clicking on File, then Exit.

All these options are explained in detail in Chapters 2 and 3.

At the top of the Main Screen, you will see the blue title bar. There you will notice the name of the current cam is contained in square brackets [] (if you did load in a Cam Test at program startup or opened a file by clicking on File, then Open). The program has several examples of cams saved in the Test Libraries' Example folder right from the factory.

To get started, let's try a couple of Menu commands. Click on the Graph menu command to open up the graph options menu shown in Figure 1.3. That Graph Type shown in Figure 1.3 is for intake data. If you want to include the exhaust lobe also, click on the down arrow to select "Int & Exh Cam Data", or some other graph Type.

Click on the Make Graph button to produce the graph shown in Figure 1.4. At the graph screen you have several other options available for changing the graph. These options are available by clicking on the commands in the menu bar or on the buttons at the top of the screen, including the Help command. The Help command at this screen (and most screens) provides a good background on what the various options are. For now, just click on Back at the upper left to return to the Main Screen.

A Test File is made up of the cam data (cam lift and degree wheel data) and other data like Degree Wheel Type, Cam #, Operator, Comments, etc. This is explained in Section 3.5 "Data Libraries". Click on the Test Setup and Cam Specs command to obtain a menu as shown in Figure 1.5.

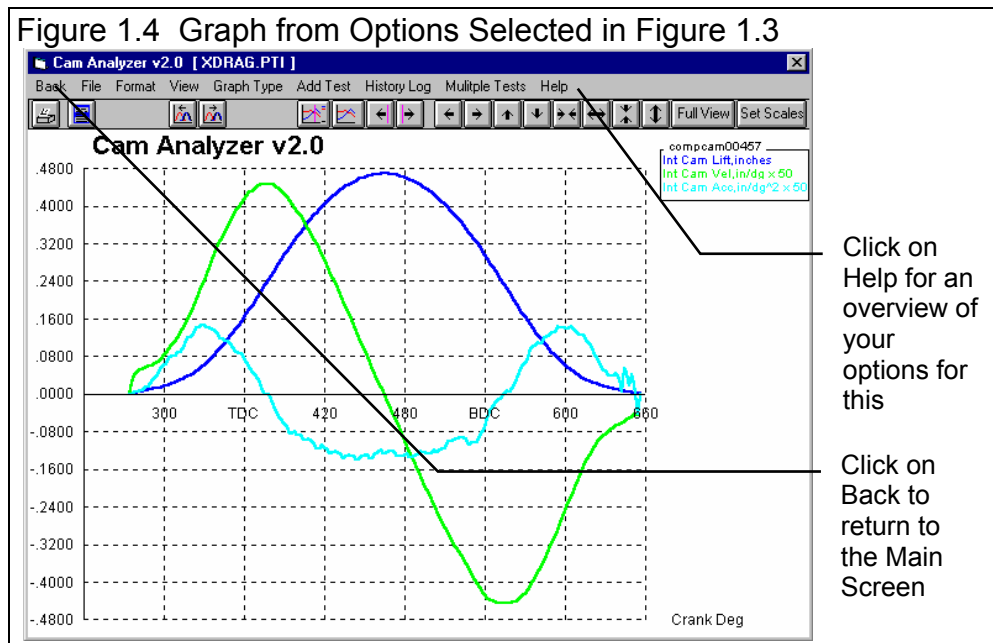
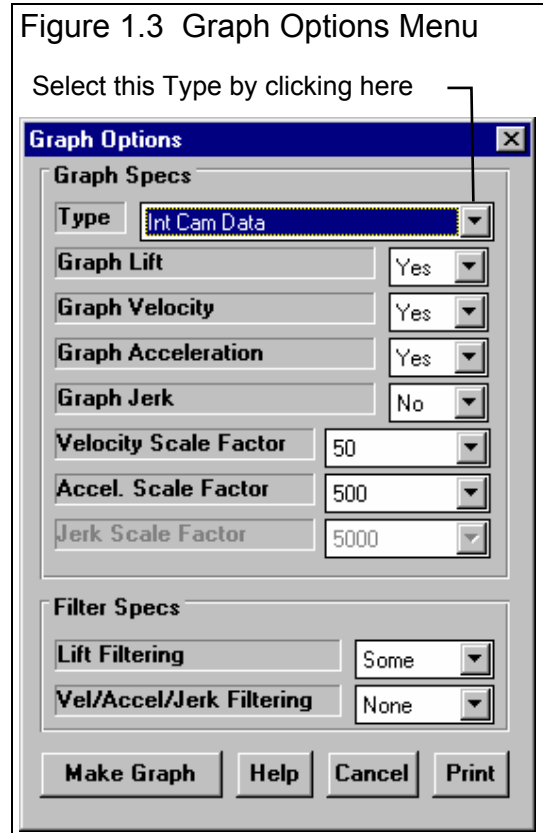

Click on Help for an overview of your options for this

Click on Back to return to the Main Screen

These specs are used for calculating certain outputs (like valve lift from rocker ratio and lash, etc), and they are useful descriptions to remind you of what this cam was in the future.

Many of the input specifications you see in the various menus may not be familiar to you. For a brief definition of the inputs, simply click on the specification name. The definition will appear in the Help frame with a page #

Figure 1.5 Test Setup and Cam Specs

The screenshot shows the 'Test Options' window with the following data:

Field	Value
Type of Cam Data	Measured by Hand
Deg Steps	5 deg
Lifter (profile) Type	Aggr Solid Roller
For Cyl #	#1
Rocker Arm Ratio	1.5
Actual Valve Lash, in	.020
Centerline, deg ATDC	103.3
Max Lobe Lift, in	.469
Gross Valve Lift, in	.704
Designed Vlv Lash, in	
Total Cam Advance	1.3 Advance
Lobe Separation, deg	104.6

The 'Degree Wheel' section shows a circular diagram with 'TDC' at the top, 'BDC' at the bottom, and '90' on both sides. The 'Help' section contains the text: 'Ratio of valve lift to tappet lift, usually 1.3-1.8 for rocker arm systems. For direct acting systems enter 1. p 48'.

Click on most any spec or spec name, and a brief Help description is given here in the Help Frame, with a page # in this manual for additional info.

in this manual for more info. (For some screens, you will have to click on the Help button for definitions of specs.)

Once you feel comfortable changing specifications in the various menus and making various performance calculations, read Section 3.5 of this manual called Data Libraries to learn how to save a set of cam data or component specifications or recall information which has been previously saved. Then you will know all the basic commands to operate the program. For a more in-depth knowledge of using these commands and an explanation of the results, read this entire manual.

Chapter 2 Definitions

2.0 Basic Program Operation:

Whenever you start the Cam Analyzer, you are brought to a Main Screen which will look like either Figure 2.1 or 2.3. If you have not yet selected a cam to work with and have not started a new cam, the Main Screen is mostly blank, like Figure 2.1.

If you want to Open a previously saved cam, you can click on File in the upper left corner, then click on Open (from all saved cams). You will get a screen as shown in Figure 2.2 where you are presented with a list of saved cams in the Test Library. Some cams are examples provided by Performance Trends. As you run cams yourself and save the results, you will add many more cams to the library. These saved files are useful for making comparisons in the future, and can be used as cam patterns (or templates) for new cams (saving you considerable time by not having to type in specs which match a past cam).

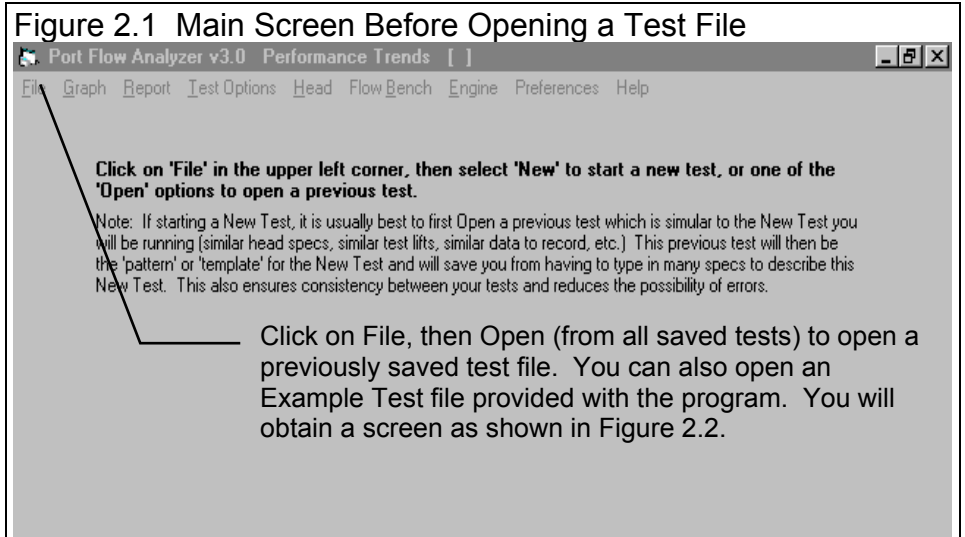

Figure 2.2 shows that the Test Library is divided into sections (called Folders in Figure 2.2) to help organize a large number of cams. For example, all cams for the company ABC Engines could be saved under a section name of ABC-ENG. All 4 cylinder Ford cams could be saved under a section name of 4CYL-FORD. This will save considerable time and confusion when trying to locate a particular cam in the future. To look in different sections, click on the Folder name from the list shown at the lower right of Figure 2.2. The list of cams will then be updated for that Folder. To pick a cam, simply click on it from the list of cams, then click on the Open button. (For those familiar with computers, Folders are actually subdirectories or folders in the CAMDATA folder. The Name "Folder" can be changed to something else, like "Customer" in the Preferences menu.)

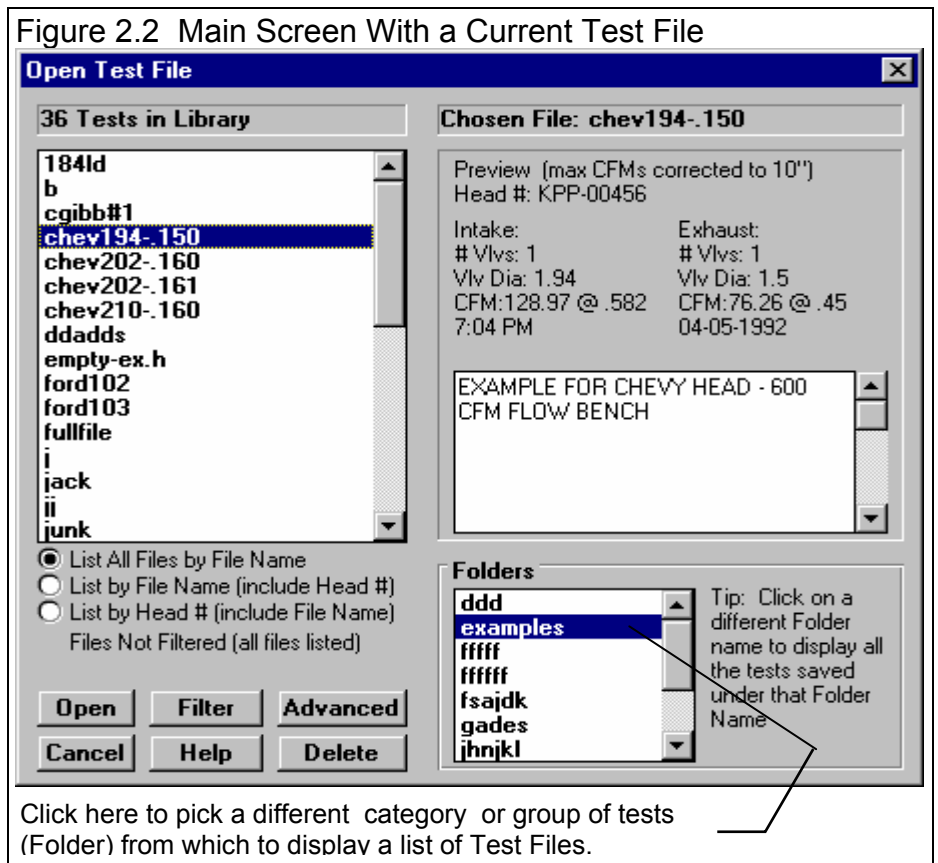

Figure 2.3 Main Screen After Opening a Test File

The screenshot shows the main interface of Cam Analyzer v2.0. At the top, the title bar reads "Cam Analyzer v2.0 Performance Trends [XDRAG.PTI]". Below it is a menu bar with "File", "Graphs", "Reports", "Test Setup & Cam Specs", "Find TDC", "Preferences", and "Help". Two tabs are visible: "Intake #2" (selected) and "Exhaust #2".

The "Test & Valve Train Conditions" section contains:

- Test Time/Date: 12:42 PM 02/07/1994
- Rckr Ratio/Lash: 1.5 / .020
- Cam Number: **CompCam00457**
- Test Operator: Jack

The "Test Comments" section contains:

- Example of Drag Race Roller Cam
- Int=280 @.050/.471 Exh=292 @.050/.420 are specs
- Help: Click on one of the Tabs here to change to a different Cam Lobe.

The "Test Data" section features an "EZ Data Entry" table, "Generate Degree Wheel Readings" and "Show Degree Wheel" buttons, and a graph. The table has columns for Point, Degree Wheel, and Tappet Lift. The graph shows cam lift curves for intake (blue) and exhaust (red) lobes.

Point	Degree Wheel	Tappet Lift
1	35. BTDC	.002
2	80. BTDC	.005
3	75. BTDC	.008
4	70. BTDC	.011
5	65. BTDC	.014
6	60. BTDC	.018
7	55. BTDC	.022
8	50. BTDC	.028
9	45. BTDC	.035
10	40. BTDC	.043
11	35. BTDC	.052
12	30. BTDC	.054

The graph displays cam lift curves. The x-axis is labeled with TDC, 90, BDC, 270, TDC, 450, BDC, 630, TDC. The y-axis ranges from 0.0 to 0.5. A blue curve (intake) and a red curve (exhaust) are shown.

Annotations:

- Menu Commands of File, Graph, etc. These give you all the options to operate the program and change test data.
- Name of Current Test File
- Click on these tabs to switch between intake and exhaust lobes on this particular cam.
- Enter most any test comments here to keep notes about this cam or test.
- Move the mouse over an area on the screen, and a Help description of that item is given here.
- This summary graph shows cam lift from each lobe. The graph for the lobe you are currently displaying is graphed in color, blue if intake, red if exhaust.
- Click on the graph for that data to be displayed in the Test Data grid.
- Click on Slide Bars to display more Test Data, which may not be able to fit on the screen.
- Click on a lift in the Test Data grid to enter cam lift.
- You can NOT type in Degree Wheel readings directly. They CAN be changed by clicking on Generate Degree Wheel Button or Clicking in the 'Point' column.
- Click either in the first column (Point column) or top row (with titles of the columns) to open up an Edit menu to change or delete data, etc.
- A summary of critical test settings is given here. Click on a setting to change it (in the case of Cam Number), or to bring up the menu where it can be changed.

If you *are* working with a particular cam, the data will be presented as shown in Figure 2.3. Notice in Figure 2.3 that a current cam name is listed at the top in square brackets []. This is the file of cam specs, cam lift data and degree wheel specs which are currently saved in the Cam Library, and are the data and specs you are currently working with. If you change the cam data or specs, make a graph or Report, it is for this cam file.

If you click on one of the Menu Commands at the top of the Main Screen, you can be presented with a screen of specs, as shown in Figure 2.4. Figure 2.4 discusses some of the commands to enter or change settings at this menu.

Figure 2.4, Explanation of Sections of Typical Menu (Test Setup and Cam Specs Menu)

Names of specs. Click on them for a description in the Help frame in the lower right corner.

Standard text entry box where you can type in a number for a spec.

Drop down combo box. For some specs (like Cam Advance) you can either type something in the box, or click on the arrow button to select a pre-programmed selection. For most others you can only select from a list of pre-programmed choices.

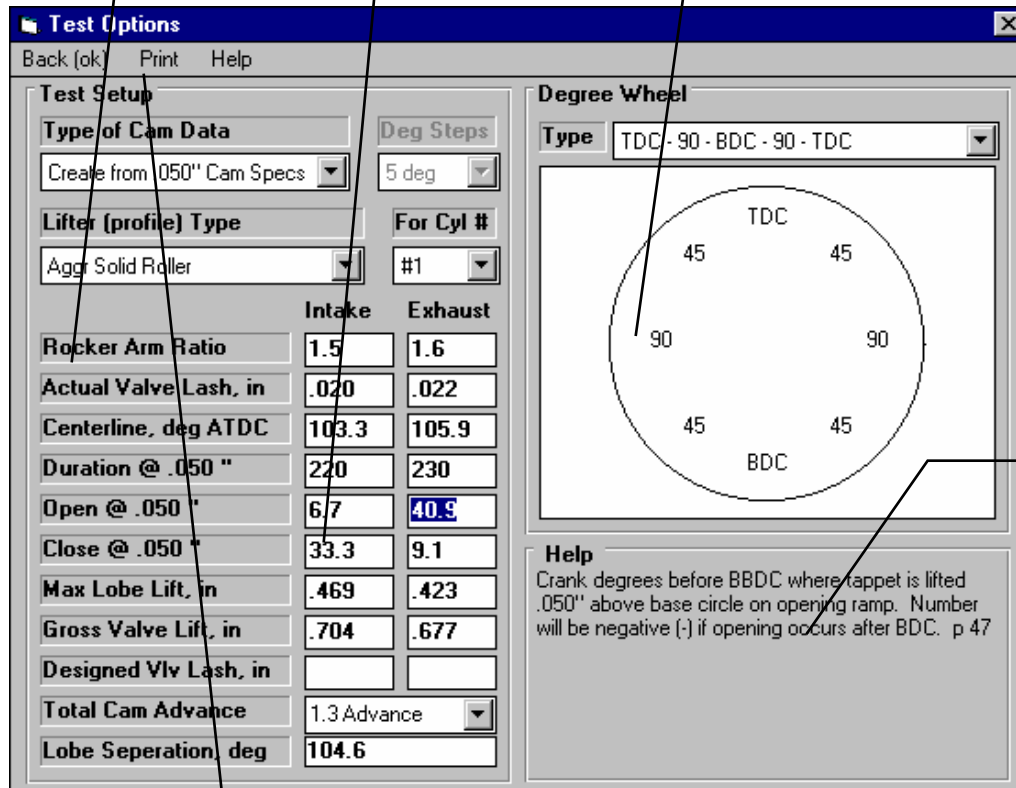

A definition of the spec you are currently highlighting (working with) is given here with a page # in this manual for more information.

Standard menu commands which provide the options for closing this menu (Back), printing this screen (click on Print), etc. See the sections later in this chapter for more details on individual menus.

2.1 Main Screen (Test Data) Inputs

With introduction of Cam Test Stand, these settings have greatly expanded. Check Appendices 4-6.

The Main Screen is shown in Figure 2.5 and is designed to resemble a typical paper data sheet. Like a paper data sheet, you enter cam lifts for various Degree Wheel readings as needed. The Main Screen is made up of 5 basic sections as shown in Figure 2.5. These are discussed in the next 5 sections. The rest of this section gives an overview of how a Cam Test is organized.

Figure 2.5 Main Screen After Opening a Test File

5) Menu Commands of File, Graph, etc. These give you all the options to operate the program and change test data.

1) Click on these Tabs to switch between the different lobes on this cam.

2) Test Setup and Cam Specs summarizes some critical specs, and includes a Test Comments section to keep notes about this test.

3) This Summary Graph shows how cam lift for the lobes compare. The lobe you are currently displaying is graphed in color, blue if intake, red if exhaust.

4) Click on most any cam lift to enter cam lift data or to change it. You can also click on the EZ Data Entry button for a faster way to enter cam lift data by hand.

Click on This button to either Show or Don't Show the Degree Wheel graphic, with the pointer identifying the current Degree Wheel Reading.

Point	Degree Wheel	Tappet Lift
1	85. BTDC	.002
2	80. BTDC	.005
3	75. BTDC	.008
4	70. BTDC	.011
5	65. BTDC	.014
6	60. BTDC	.018
7	55. BTDC	.022
8	50. BTDC	.028
9	45. BTDC	.035
10	40. BTDC	.043
11	35. BTDC	.052
12	30. BTDC	.064

2.1.1 Tabs

A cam test is made up of 2 Test Data grids, 1 intake and 1 exhaust, each with a tab as shown in Figure 2.5. You move to different lobes by clicking on the Tabs at the top of the screen.

2.1.2 Test Setup and Cam Specs

Test Time and Date

This records the time and date at the start of the cam. When a cam is started with the New Test command (click on File, then click on New Test at the Main Screen), the computer's current time and date are saved as the test time and date. The test time and date can also be changed by clicking on it here at the Main Screen.

Rckr Ratio/Lash

Describes the rocker arm ratio and valve lash for the lobe being displayed. Click on this item to display the Test Setup and Cam Specs menu where this data is contained.

Cam Number

Cam Numbers can be critical for shops installing many cams a year. The program keeps track of #s so you don't assign duplicates or skip #s.

Consistency of Cam # pattern also makes it easy to find cams in the Test Library. If you click on the Cam # spec, the menu of Figure 2.6 is displayed. This menu lets you pick a new cam # 3 different ways.

1. You can start a new Cam # format if you select Yes for Enter a New Number Format. For example, say you currently are using 'Johnson0012' as a Cam # for 1 customer Johnson. Now you have a new customer Smith and you want to start with #s like 'Smith0000'.
2. You can simple use the last Cam # used, incremented up by 1 you select No for Enter a New Number Format.
3. Select No for Enter a New Number Format, then select some other Cam # (not the last Cam #) from the Numbers list, and a new Cam # will be created from it. This new # will be, either the exact # you picked (typical if you are flowing a cam which you have already flowed), or incremented up by 1 if you request it (typical if you are working with a new cam but with the same Cam # format). This is a list of the last 100 Cam #s you have assigned.

If you want to type in most anything you want for a Cam Number, or leave it blank, go to the Preferences menu and set Allow Direct Entry of Cam Numbers to No.

For Advanced Users: To delete or change #s in this list, use Wordpad or Notepad and edit the 'headnum.pti' file in the CA20 folder, but keep a backup in case you make a mistake.

Test Operator

This is the name of the operator who ran the cam. Click on this item for the menu of Figure 2.7 to be displayed, where you can type in a new operator name, or choose from one you have previously entered. It is always recommended you first check the list of existing operators, so you do not end up with several names for the same operator. For example, Bob, Bobby and Robert may all be for the same guy.

To pick an existing operator name, pick No for Enter a New Operator, then pick from the Operator list. To enter a New Operator name, pick Yes for Enter a New Operator, then type in a New Operator name, which will be added to the list of operator names.

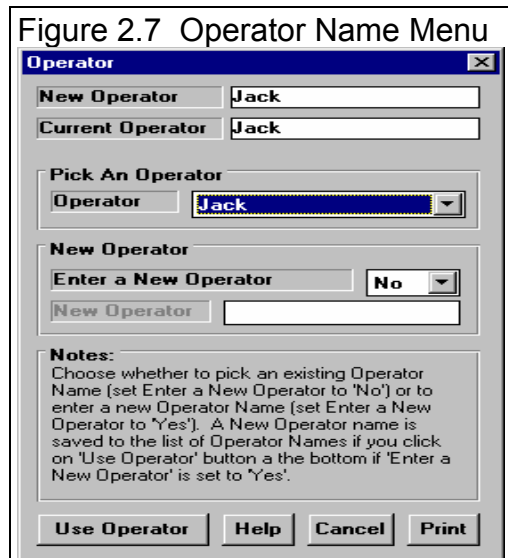
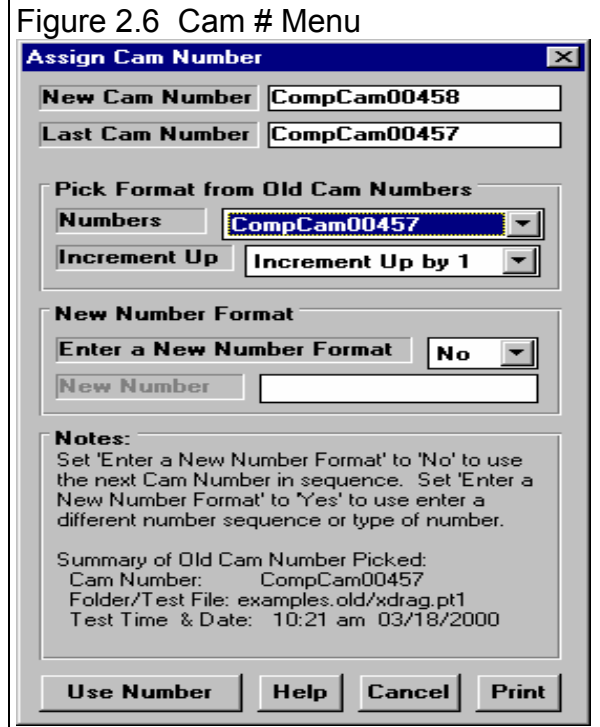

Test Comments

Test comments are for making most any notes about the cam, unusual observations, customer requirements, etc. These comments are saved with the cam file and can be printed with the reports and graphs.

Help

The help frame will describe whatever portion of the screen the mouse has passed over or clicked on.

2.1.3 Summary Graph

The summary graph shows cam lift graphed versus Degree Wheel reading for both the lobes on this particular cam (Figure 2.5).

A useful feature of the Summary Graph is that if you click on a part of the graph for the current lobe (a blue or red graph), that particular data point will be displayed and highlighted in the Test Data grid. This is a useful feature for finding points which look “out of line” with the rest of the data.

2.1.4 Test Data Grid

Point

The point column simply numbers the rows of data, and is used by the program to identify a row of data for messages. Another feature is if you click on a Point #, an Edit Test Data menu shown in Figure 2.8 pops up, letting you edit the row you clicked on. Other editing menus are available by clicking on the top row, for editing columns.

NOTE: Check Appendix 3, 4, 5 and 6 for new Edit features.

Degree Wheel

This is the reading on the particular degree wheel type you have requested in Test Setup and Cam Specs menu. There are several ways to enter Degree Wheel readings.

- When you first start a New Test, the Degree Wheel column will be blank. Before you can start entering cam lift data, the program will display the Generate Degree Wheel Readings menu. There you can specify the starting Degree Wheel point and the range of Degree Wheel readings you estimate you will need. Click on OK at this menu, and Degree Wheel readings will be generated for the range you specified.
- After Degree Wheel readings have been generated, you can still click on Generate Degree Wheel Readings to “re-generate” readings. This could be for extending the range or to correct some type of error you made a previous time you generated Degree Wheel Readings.
- If you enter cam lift data for the last row at the bottom of the Test Data grid, an additional Degree Wheel reading is generated automatically in anticipation you may want to enter another cam lift point.
- You can click on a row in the Point column and the program will present an Edit Options menu shown in Figure 2.8. There you can add or delete rows, or advance or retard the degree wheel readings.

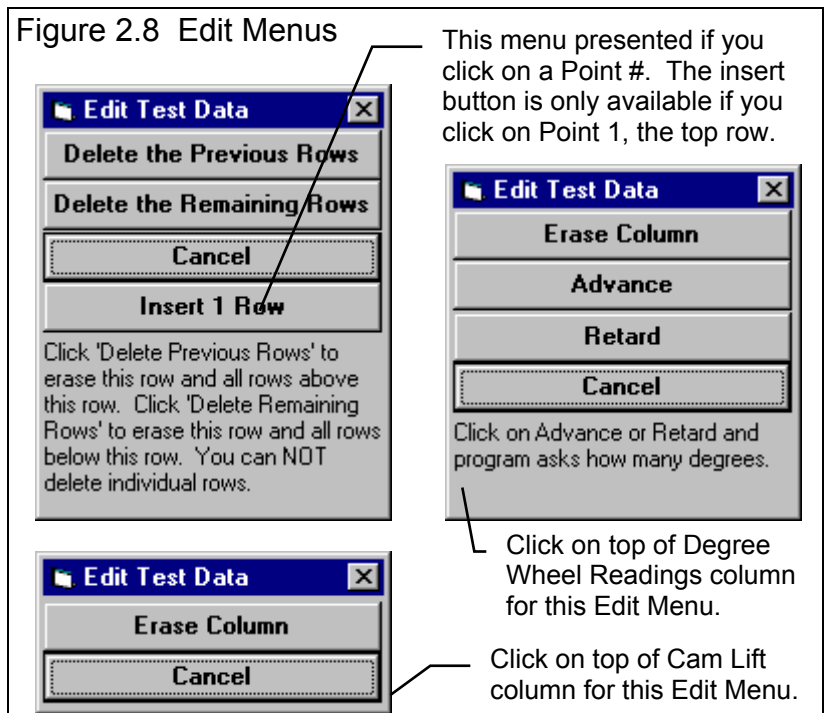

The steps between consecutive Degree Wheel Readings is set in the Test Setup and Cam Specs menu, usually 2, 4, 5 or 10 degrees. The smaller the increment, the more precise the cam measurement but the more time required to enter the data. All Degree Wheel readings for a particular test are at the same increment. You can not insert a Degree Wheel reading at a 2 degree increment when the other increments are at 4 degrees.

Tappet Lift

Is the cam lift (sometimes called follower, lifter or lobe lift) recorded from the dial indicator as you turn the cam and crank to each Degree Wheel reading. As lifts are entered, they are automatically graphed in the Summary Graph to help you spot problems immediately.

2.1.5 Main Screen Commands

The next section discusses some of the commands available at the top of the Main Screen. Most will not be discussed here in detail, as they are discussed in other sections of this manual.

File (see Figure 2.9 for File Options)

New (start new test)

Click on File, then New to start a new test. This process will “walk you through” some critical steps to start with a blank Test Data grid, or to keep certain data from the previous cam. Keeping data can save you considerable time since you don’t have to type in information which may be the same as the current cam. The New Test command is discussed in full detail in Section 2.6, page 35.

Open (from all saved tests)

This option presents the Open Test File menu discussed in Section 3.5 page 67, Data Libraries. From there you have several options to open a previously saved cam file from any place in the Test Library, or from most any place on the computer, including the floppy disk drive.

Open (from History Log)

This option presents the History Log, a chronological list of cam files you have been working with as discussed in Section 3.7, page 75. From there you can review a summary of the last 25 to 100 cams, and pick one to open. This method can make it easier to find a file you have just worked with lately, say in the last couple of weeks.

Save

Select Save if you want to save the current cam and any recent changes *to the same name* as you are currently working with. This is the file name shown in square bracket [] at the top of the Main Screen.

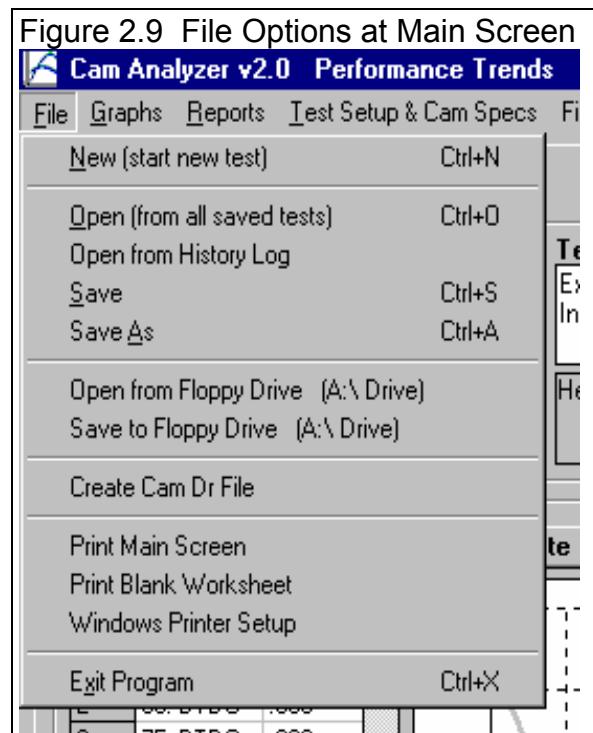

Save As

Select Save As if you want to save the current cam and any recent changes *to a new name or new folder*. You will be presented with the menu discussed in Section 3.5 page 67 where you can change the cam name, change the folder you are saving it to, or add a new folder name.

Open from Floppy Drive

This command provides a simple 1 click command to open a standard Windows "File Open" menu displaying the contents of the disk in the Floppy Drive. This provides a convenient method for copying files from one computer to another.

Save to Floppy Drive

This command provides a simple 1 click command to save the current cam file to the disk in the Floppy Drive to the same name as is currently being used. This provides a convenient method for copying files from one computer to another.

Create Cam Dr File

The Cam Dr (tm) is a popular computerized cam measurement tool. It stores its data on disk so it can be retrieved later for analysis by the Cam Dr's software, or used in other software. Performance Trends' Engine Analyzer' Pro' can read a Cam Dr file to precisely simulate valve train dynamics and engine performance with your exact cam profile. Therefore, if you want to create a cam profile file of the current Cam File shown on the Main Screen, you would use this command.

See Section 3.8 for more details.

Print Main Screen Print Blank Worksheet Windows Printer Setup

The Print Main Screen and Print Blank Worksheet commands simply give you instructions how to do each. These commands were placed under File as many users will look under File to find these print options. The Windows Printer Setup lets you change your Windows default printer, paper orientation, etc for printing Reports or graphs in other areas of the program.

Graph

The Graph command lets you graph several different types of data from the current cam, either by itself or with data from other cams for comparisons. The Graph options are discussed in detail in Section 3.3, page 51.

Report

The Report command lets you create Reports of several different types of data from the current cam, either by itself or with data from other cams (Pro version only) for comparisons. The Report options are discussed in detail in Section 3.1, page 41.

Test Setup and Cam Specs

The Test Setup and Cam Specs command opens up the Test Setup and Cam Specs menu. There you tell the program what type of cam data you are working with, what type of degree wheel you are using, etc. Test Setup and Cam Specs are discussed in detail in Section 2.3, page 21.

Preferences

Preferences let you customize the program for your needs and for your computer and printer. See Section 2.2, page 19.

Help

Click on Help for several options to help describe your options at the Main Screen, and for other information to help you understand how this program works.

2.2 Preferences

Note: Preferences have been greatly enhanced in v3.2 through 4.0. Check Index and Appendices 3-8 for these new features.

Click on the Preferences item in the menu bar at the top of the Main Screen to bring up the Preferences menu shown in Figure 2.10. Here you can adjust some program items to personalize the program for your needs. Preferences may also save time by eliminating steps you don't require.

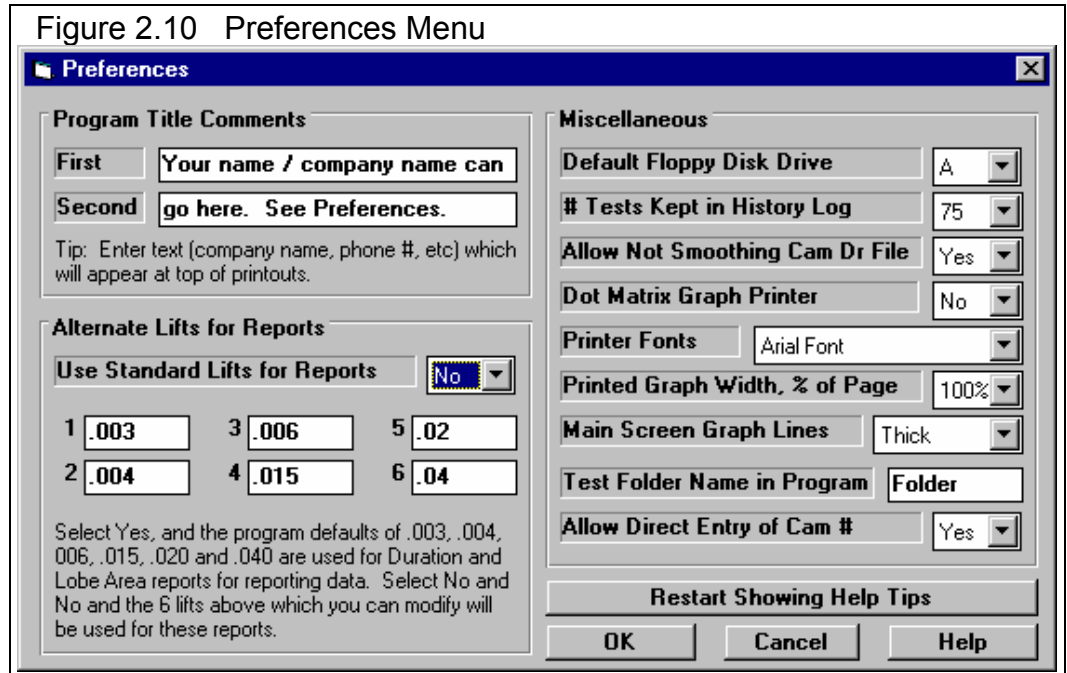

Program Title Comments

Enter most any text here for the First and Second lines. These 2 lines will appear at the top of printouts and printed graphs. This is a good place for your business name or your personal name. You can change these entries as often as you wish.

Alternate Lifts for Reports

Use Standard Lifts for Reports

Special reports which display cam lobe area, durations, and opening and closing events at specific **cam** lifts. Select Yes for this spec and the program will use its default low lifts, plus the additional defaults of every .050" lift from .050" up to .500" cam lift. Select No, and the 6 cam lift input boxes become enabled, where you can enter most any cam lift between 0 and 1 inch. Now data will be reported at these lifts you have specified.

Note that these are **cam** lifts. If you want to specify a particular **valve** lift, you must divide by rocker arm ratio. For example, to specify .030" valve lift (like .030 valve lash), you would specify .020" (.030 / 1.5 = .020).

Default Floppy Disk Drive

Choose the letter of the floppy disk drive on your computer, usually A. This is the disk drive which will be first opened when using the Save to Floppy Disk or Open from Floppy Disk File commands at the Main Screen.

Printer Fonts

Choose which basic type of font to use for printouts. You may not get your choice if your printer does not support that particular font.

Allow Not Smoothing Cam File

Choose Yes for this specs and an additional option shows up in the Create Cam Dr File menu, which allows the user to pick if they want the cam data smoothed or not before the Cam Dr File is written. Since we strongly recommend that the data is always smoothed, this preference is set to No when you first get the Cam Analyzer.

Tests Kept in History Log

Pick the number of cams which you want the History Log to hold, from 25 to 100.

Printed Graph Width, % of Page

Due to the endless combinations of computers, Windows setups and printers, some printed graphs may not fill the page, some may extend off the page. This option lets you expand (% greater than 100) or shrink (% less than 100) the printed graph to better fit the page.

Main Screen Graph Lines

This option lets you choose the line thickness of the summary graph of cam lift vs crank degrees on the Main Screen.

Graph Dot Matrix Printer Adjustment

Choose Yes if you are getting breaks in the border around printed graphs (usually happens with dot matrix printers).

Test Folder Name in Program

The Cam Analyzer saves cams under different folders (directories) under the main folder CAMDATA. Some users may prefer to have the 'Folder' be called 'EngFamily' or 'Customer', depending how they choose to organize their cams. Your entry here of most any text up to 9 characters is what the program will use to call the different folders where cam files are stored.

Allow Direct Entry of Cam Numbers

Choose yes, and you can type in most anything you want for a Cam Number, or leave it blank. Choose No and the program directs you to a Cam Number menu where you can check previous numbers which have been used. This menu also directs you to create numbers which are in a format of letters followed by numbers, like ULDYN000455. This could stand for the 455th UltraDyne (tm) cam you have purchased. If you are in a big shop, with several people creating cam files, No may be the better choices to keep consistency in numbers.

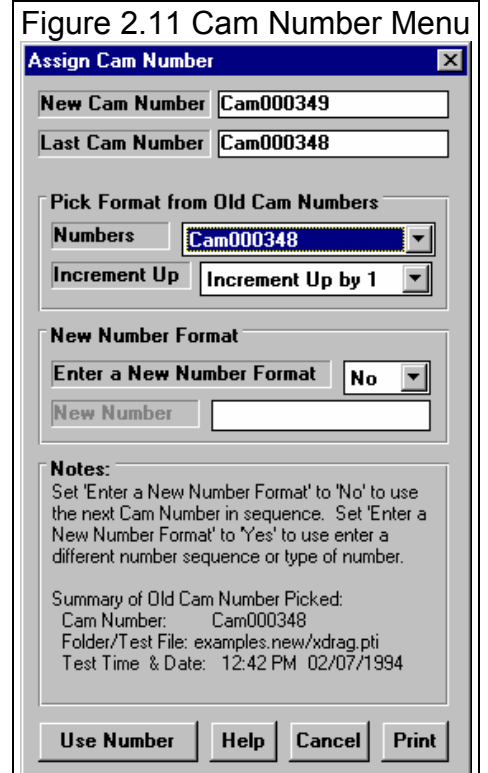

2.3 Test Setup and Cam Specs

With introduction of Cam Test Stand, these settings have greatly expanded. Check Appendices 4-6.

The Test Setup and Cam Specs determine what type of cam file you are working with and what data is recorded, lets you enter specs for producing valve lift curves, and specifies the type of degree wheel you are using.

Type of Cam Data

Click on the down arrow button to select how the cam lift data was generated. Choices are basically:

- Entered by hand
- Generate from cam specs
- Computer Cam File

Entered by hand is the type you will use if you are going to measure a cam using a degree wheel and dial indicator. If you choose this type, several specs in this menu are then not shown as they are not needed by the program.

Generate from Cam Specs is a method where the program will create an entire profile based on simple specs you will enter in this menu, like duration, centerline, etc. This choice will display all Test Setup specs because they can all be used to generate the cam profile. The American aftermarket standard is .050" lift. Metric and motorcycles use .040" (1 mm). Seat timing is also called 'advertised' duration and is not as accurate a method. The Deg Steps spec becomes disabled (dimmed to gray and you can not change it) because the program always uses 2 deg steps for generating profiles. **Note: The Cam Analyzer is NOT a cam design program, and the profiles generated are only approximations of a particular cam profile.**

Computer Cam File is used if you have opened up a cam file which was created by some other type of computer program or cam measurement system. Typical cam file formats that the Cam Analyzer can read include:

- From Cam Dr File
- From Cam Pro File
- From Comp Cam's File - Intake
- From Comp Cam's File - Exhaust
- From Dr Doctor File - Intake
- From Dr Doctor File - Exhaust
- From S96 File - Intake
- From S96 File - Exhaust
- From Andrews File - Intake
- From Andrews File - Exhaust

Figure 2.12 Test Setup and Cam Specs Menu

This "Type of Cam Data" spec is critical. Its setting can completely change how this screen looks.

Click on File, then Print or Windows Printer Setup to print this screen.

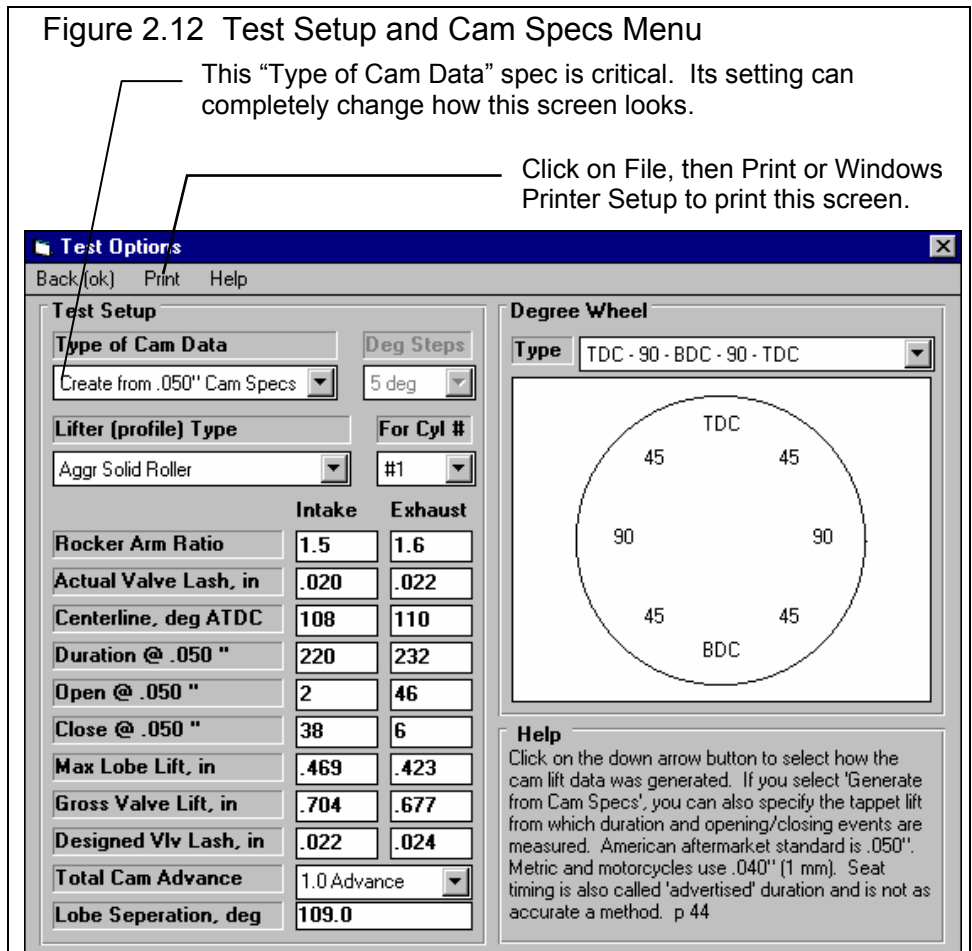

Usually these Computer Cam File types are entered by the program itself when you open one of these types of cam files from the Cam Library. See Section 3.6, Opening Other Cam File Formats.

Deg Steps

Click on the down arrow button to select how many degrees between each cam lift measurement. The smaller this number the more readings required (if you are entering data by hand) or the more readings generated (if you are generating from the simple cam specs).

Lifter (profile) Type

This combo box lets you pick the type of lifter and the “steepness” or “aggressiveness” of the cam’s profiles. The combinations consist of:

Hyd vs Solid	Hydraulic vs Solid lash adjustment
Flat vs Roller	Aggressiveness or steepness of the profile (Roller being more aggressive)
Mild vs Agr	Aggressiveness or steepness of the profile (Agr being more aggressive)

The choice of Hydraulic vs Solid is the most important as this dictates the use of a lash setting. The other choices simply determine differences in the steepness of the profile *for the same Max Lobe Lift*. Most truly aggressive cams or roller cams have more Max Lobe Lift for a given duration, and milder or hydraulic cams have less Max Lobe Lift.

For Cyl

Click on the down arrow button to select the Cylinder # for this particular cam lobe. This is mainly used when you are measuring a cam lobe or reading a cam file.

Important: The specs below may update (change) as you change other specs. For example, if you change a centerline, the Total Cam Advance number changes to reflect the new centerline.

Rocker Arm Ratio

Identifies the ratio between tappet lift and valve lift. Generally rocker arm ratios vary between 1.3 to 2.0. For valve trains with no rocker arms, for example overhead cam systems with directing acting tappets, enter 1. See Figure 2.13. The Pro assumes the ratio is constant although actual rocker arm ratios vary slightly with valve lift.

Figure 2.13, Various Valve Train Designs & Estimated Rocker Arm Ratios

**Pushrod
Overhead Valve**

R.A.R. = 1.3-1.7

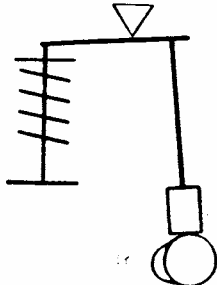

**End Pivot
Overhead Cam**

R.A.R. = 1.3-1.7

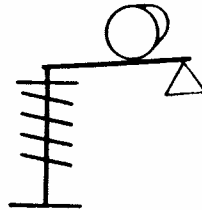

**Direct Acting
Overhead Cam**

R.A.R. = 1.0



Actual Lash @ Valve, in

Identifies the lash or clearance in inches between the valve tip and its actuator, generally the rocker arm. If you have specified a hydraulic Lifter (profile) Type, this spec is disabled.

Notes: This spec works with the Designed Valve Lash spec. If you specify an Actual Valve Lash nearly the same as the Designed Valve Lash, the valve will be opened as the cam profile was designed. If you specify a smaller Actual Valve Lash than the Designed Valve Lash, the valve will be opened longer and higher than what the cam was designed for. And vice versa, if you specify a larger Actual Valve Lash than the Designed Valve Lash, the valve will be opened less time and less lift than what the cam was designed for.

Centerline, deg ATDC

Is the location of the maximum lift point on the cam profile. If you are letting the program generate a standard cam profile, this is also exactly half way between the open and closing point because the program only generates the same opening and closing profile (a symmetric lobe). This is not necessarily the case if you are working with a Cam File or Measuring a Cam by hand, which may have very different opening and closing profiles.

Duration @ xxx

Is the number of crank degrees where the tappet is lifted to the cam lift specified as the Lift for Rating Events above base circle.

Opening @ xxx

Identifies crankshaft degrees before top dead center where the tappet has been lifted to the Rated Tappet Lift above Base Circle on the opening ramp. (Rated Tappet Lift is specified previously.) This value is generally available on your "cam card" or in cam catalogs. If this event occurs after top dead center, enter a negative value. For example, if it is reported as 4 degrees after top dead center, enter -4.

Closing @ xxx

Identifies crankshaft degrees before top dead center where the tappet has been lowered to the Rated Tappet Lift above Base Circle on the closing ramp. (Rated Tappet Lift is specified previously.) This value is generally available on your "cam card" or in cam catalogs. It is highly unlikely, but if this event occurs before bottom dead center, enter a negative value. For example, if it is reported as 4 degrees before bottom dead center, enter -4.

Max Lobe Lift, in

Identifies how high the cam lobe lifts the tappet above Base Circle in inches. If you are given "gross valve lift" by the cam grinder, divide by the rocker arm ratio *assumed by the cam grinder* to obtain gross or maximum tappet lift. Note that the rocker arm ratio *assumed by the cam grinder* may not be the rocker arm ratio you are actually using.

Gross Intake Valve Lift, in

Is the maximum lift of the valve with NO valve lash (even if it is a mechanical cam with valve lash). Mathematically it is Max Lobe Lift multiplied by rocker arm ratio. This is the standard way most cam grinders rate their cams for valve lift, sometimes called Advertised Lift. This number is calculated from other specs in this menu and can not be entered directly.

Note: If you are not using (specifying in the program) the same Rocker Arm Ratios as what the cam grinder is assuming, this number will not match the cam grinder's catalog or advertised lift.

Designed Valve Lash, in

Is the valve lash the cam grinder recommends you use, or what the cam was ground for. See Actual Lash @ Valve above.

Total Cam Advance

This combo box lets you either pick an advance, retard or "straight up" cam timing by clicking on the arrow key, or you can type in an advance or retard in degrees directly. If you just enter a number, a number with a + sign (ex. +4) or a number followed by the letters "adv", the program assumes it is number of degrees of cam advance. If you just enter a number with a - sign (ex. -4) or a number followed by the letters "ret", the program assumes it is number of degrees of cam retard.

Total cam advance is based on the current Intake and Exhaust Centerlines. If the centerlines are equal, Total Advance is set to 0 or straight up by the program. This method of using Total Cam Advance should match cam specs used by most cam grinders.

To change cam timing from how it was ground by the cam grinder you will need a special set of timing gears or an offset timing pin, key or bushing. In general, advancing the cam will give more lower end torque while giving up some top end HP; and retarding will give up low end torque to gain top end HP.

Lobe Separation, cam deg

Is the separation between the intake and exhaust centerlines in *cam* (not crankshaft) degrees, and is the standard method used by most cam grinders. This number is calculated from other specs in this menu and can not be entered directly.

Keep Orig File's Lobe Separation

This spec is only visible if you are working with a Cam Dr or Cam Pro Plus file, cam files which have both intake and exhaust lobes. Select 'Yes' to keep the Lobe Separation which was originally measured with the cam. This separation is displayed in the Lobe Separation box and the Exhaust Lobe Centerline spec is disabled. Select 'No' to enable Exhaust Centerline so you can specify any Lobe Separation.

Degree Wheel

Type

Click on the down arrow button to select the type of degree wheel you will use for measuring the cam. A simple sketch will be made of the wheel below.

Figure 2.14 Different Degree Wheel Types

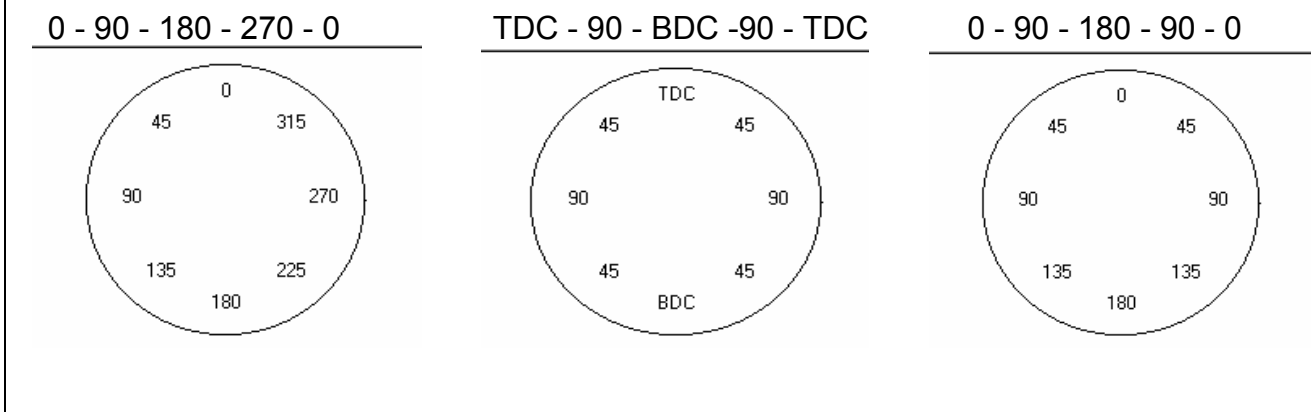

Note: If you are testing a cam out of the engine, like in a Vee block, you will have to make up a special degree wheel or modify the marks of an existing degree wheel. You would double the reading on a normal wheel to obtain the new reading on a wheel mounted on the cam. For example, for a 0 - 90 - 180 - 270 - 360/0 wheel, the readings would now 0 - 180 - 360/0 - 180 - 360/0.

2.4 Find TDC

The Cam Analyzer has a separate menu for helping you find Top Dead Center (TDC). You must have the degree wheel correctly indexed to your crankshaft before recording cam lift numbers if cam *timing* numbers are important. To do this, you must find TDC accurately. For example, if you are only interested in duration at .050", maximum lobe lift, acceleration and velocity graphs, etc., cam *timing* and indexing the degree wheel is *not* important. If you want to know centerlines, cam advance, opening and closing events at .050", then cam timing *is* important. If you don't understand the difference, then you should always find TDC so you can index your degree wheel correctly.

This screen is meant to be used as a step-by-step procedure. You should do step 3 before you do step 4, etc. Therefore, start at the top, Step 1, and work your way down the screen.

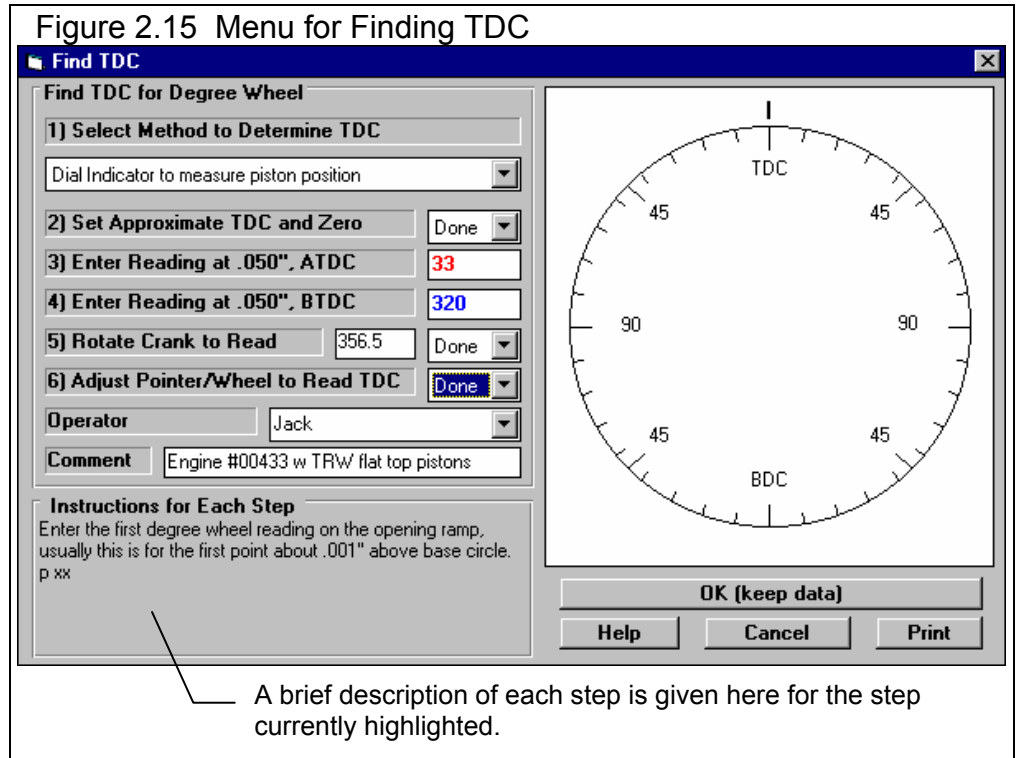

Example 4.1 shows how this menu is used for finding TDC.
Check Appendix 5 for finding TDC with the Cam Test Stand.

1) Select Method to Determine TDC

Step 1: Click on the down arrow button to select the method of determining TDC. The first method uses a dial indicator to measure piston position close to TDC. The 2nd method uses some mechanical stop to limit piston travel to approximately .050" from TDC. See Figures 2.16 and 2.17. Your choice here will change many of the other inputs and steps on this screen.

Method 1 uses a dial indicator to measure out 2 points on either side of TDC. A disadvantage of Method 1 is that the heads must be removed (or you need a special dial indicator which can access the piston dome through the spark plug hole.)

Method 2 uses a mechanical stop in the cylinder or head. A stop can be a stiff bar bolted to the engine deck as shown in Figure 2.17. Or it can be a spark plug body with the porcelain removed and a bolt welded in its place. This type can be used with the head installed, but can bend (introducing errors), damage a piston with a complicated dome, or not work at all depending on spark plug installation angle. The stop will contact the piston at the same distance from TDC with the crank on either side of TDC. Two disadvantages of Method 2 include:

- Possible damage to the piston if too much force is used to seat the piston against the stop.
- Depending on the design of stop, you may have to remove and adjust or file the stop if the degree wheel readings do not fall into the range allowed by the Cam Analyzer.

Figure 2.16 Hardware Required and Installation for Method 1, Dial Indicator Method

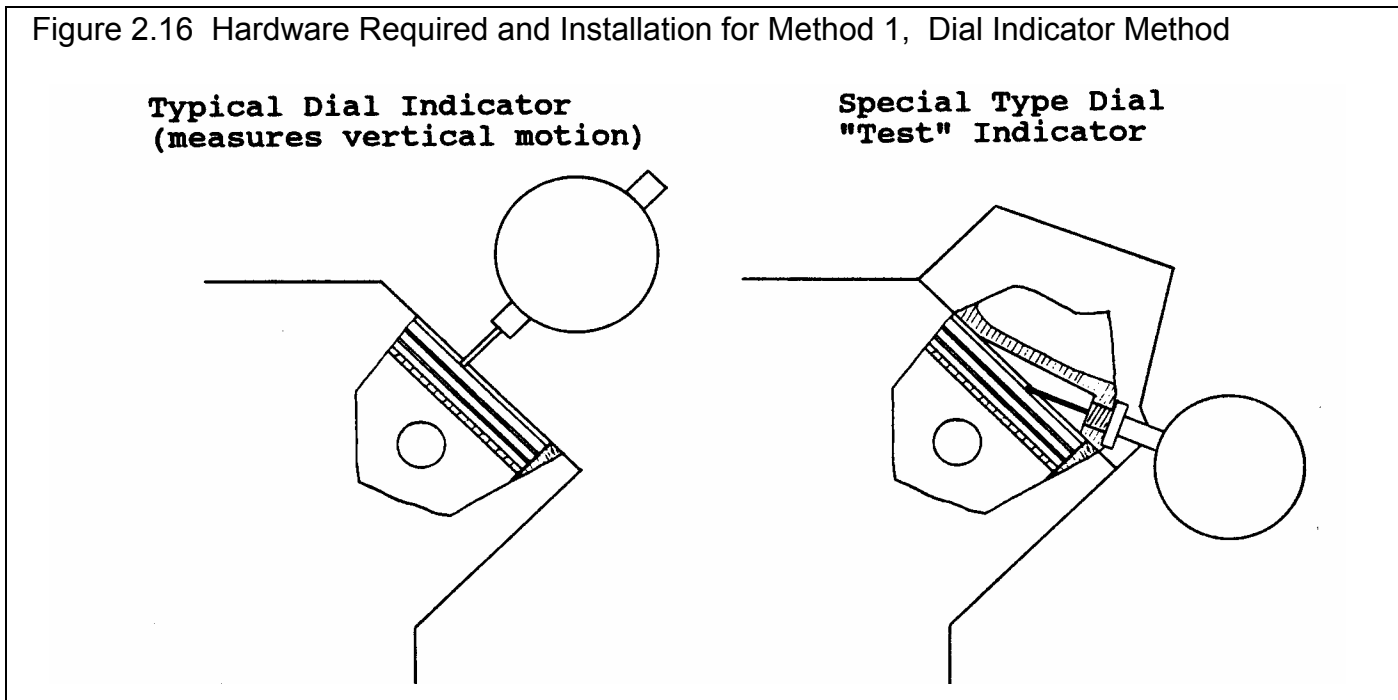

Steps for Method 1

2) Set Approximate TDC and Zero

Step 2: Position #1's piston to the highest point in the bore (approximately TDC). Install your degree wheel on the crank and pointer to read approximately TDC. Install your dial indicator and set it to read approximately .000". Choose 'Done' when done.

3) Enter Reading at .050", ATDC

Step 3: Rotate the crank CLOCKWISE until the dial indicator reads exactly .050". Enter the degree wheel reading at this point.

4) Enter Reading at .050", BTDC

Step 4: Rotate the crank COUNTER-CLOCKWISE until the dial indicator again reads exactly .050" on the other side of TDC. Enter the degree wheel reading at this point.

5) Rotate Crank to Read

Step 5: WITHOUT LOOSENING the degree wheel or adjusting the pointer, rotate the crank CLOCKWISE until the pointer reads the number as calculated by the program. This is shown in Figure 2.15 on previous page. Cyl #1's piston is now exactly at TDC. Choose 'Done' when done.

6) Adjust Pointer/Wheel to Read TDC

Step 6: WITHOUT MOVING CRANK OR PISTON, adjust the pointer (or loosen and rotate the degree wheel) until the pointer and wheel read exactly TDC. Choose 'Done' when done.

Operator

If you want, type in an Operator Name or click on the down arrow key to select from the list of operator names which have already been used.

Comment

If you want, enter most any comment of up to 40 characters to be stored with this file and printed with this screen if you choose to print this screen.

Figure 2.17 Hardware Required and Installation for Method 2, Mechanical Stop Method

"Stiff Bar" Type Stop

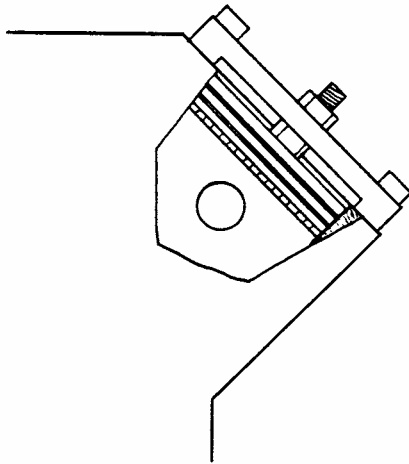

"Spark Plug" Type Stop

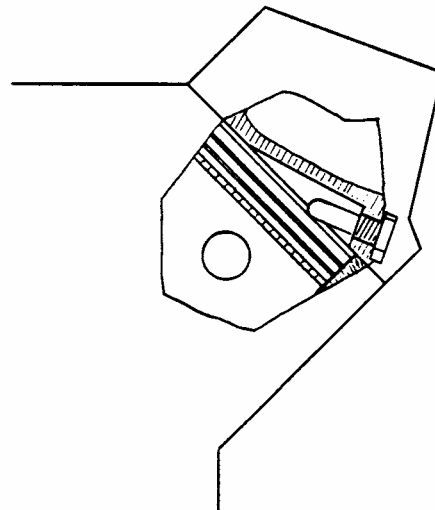

Steps for Method 2

2) Set Approx TDC, CCW, Install Stop

Step 2: Position #1's piston to the highest point in the bore (approximately TDC). Install your degree wheel on the crank and pointer to read approximately TDC. Rotate Crank COUNTER-Clockwise about 10-40 degrees. Install the 'Stop' and adjust it so it touches the piston top in this range of degree readings. Choose 'Done' when done.

3) Enter CCW Reading at Stop, ATDC

Step 3: Continue rotating the crank COUNTER-Clockwise almost a full revolution until the piston touches the stop. Enter the degree wheel reading at this point.

4) Enter Reading at Stop, BTDC

Step 4: Rotate the crank CLOCKWISE almost a full revolution until the piston again touches the stop. Enter the degree wheel reading at this point.

5) Rotate Crank to Read

Step 5: WITHOUT LOOSENING the degree wheel or adjusting the pointer, REMOVE THE STOP. Then rotate the crank CLOCKWISE until the pointer reads the number as calculated by the program. This is shown in Figure 2.15 on previous page. Cyl #1's piston is now exactly at TDC. Choose 'Done' when done.

6) Adjust Pointer/Wheel to Read TDC

Step 6: WITHOUT MOVING CRANK OR PISTON, adjust the pointer (or loosen and rotate the degree wheel) until the pointer and wheel read exactly TDC. Choose 'Done' when done.

Background

As the piston approaches TDC, there is a relationship between the crankshaft angle from TDC in degrees and the distance the piston is from TDC in inches. The same relationship essentially is true as the piston leaves TDC. See Figure 2.18.

If we could accurately measure exactly when the piston was .000 inches from TDC, we would know where TDC was on the crank. However, we can not reliably measure piston movement that accurately. As Figure 2.19 shows, a small error in piston distance from TDC in the region close to TDC creates a large error in TDC determination.

Instead, we select a piston position a fair distance away from TDC, for example .050". Here an error in piston position only produces a small error in crank angle. By finding this same piston position on both sides of TDC, and splitting the difference, TDC can be found

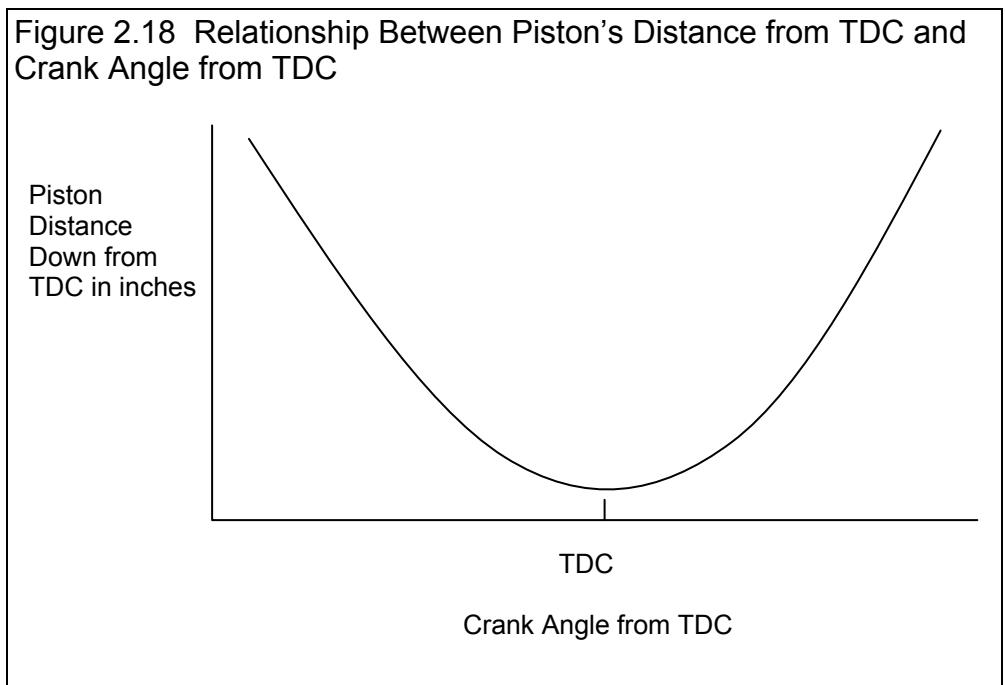

very accurately. See Figure 2.20. Note that the distance from TDC picked is not important, just that the same distance is used on both sides of TDC.

Figure 2.19 Illustration of Small Error Measuring Piston Distance for TDC Produces Large Error in Finding the Crank Angle for TDC

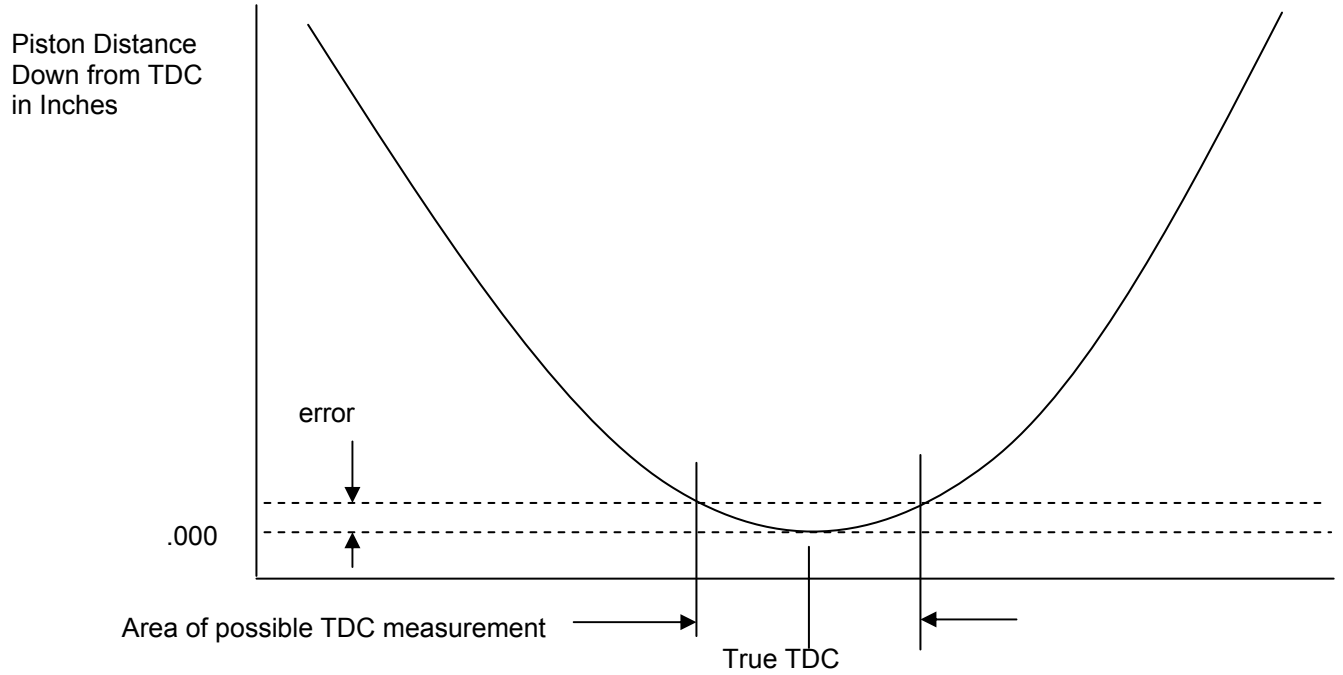
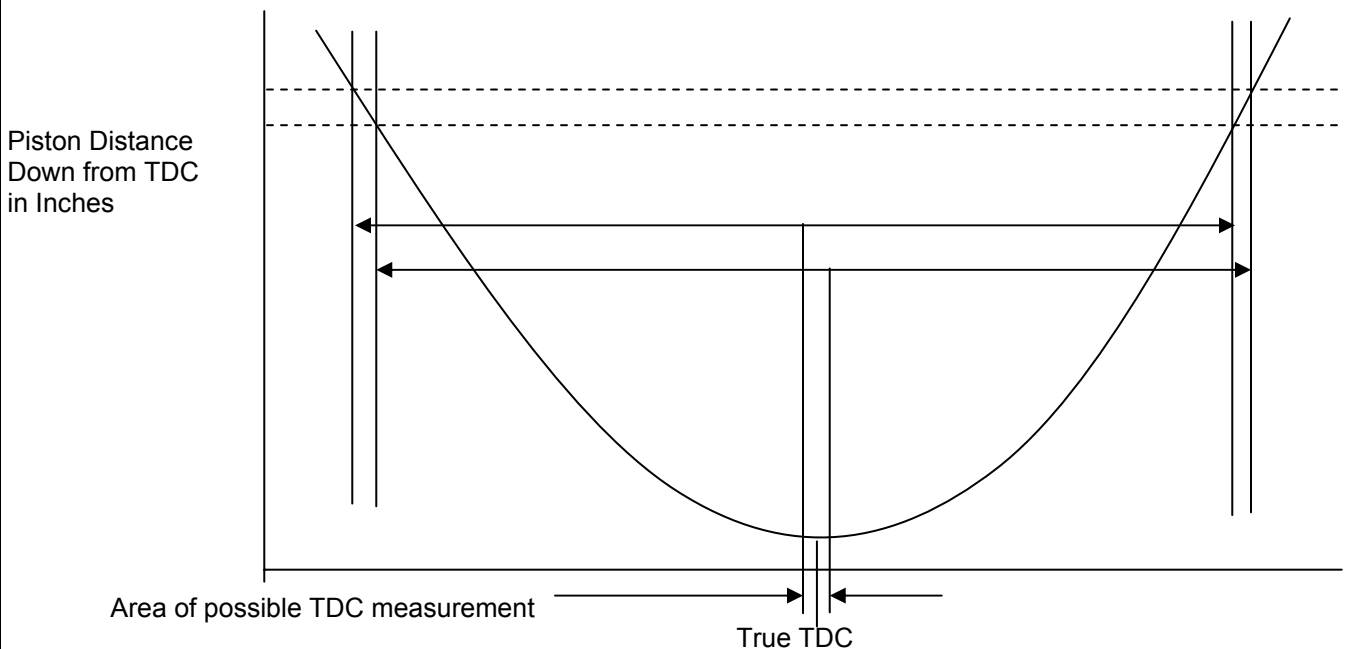

Figure 2.20 Illustration of "Split the Difference" Method, Where a Small Error Measuring Piston Distance for TDC Produces Small Error in Finding the Crank Angle for TDC



2.5 Generate Degree Wheel Readings

When you start to enter Cam Lift data after starting a New Test, or when you click on the Generate Degree Wheel Readings button, the program presents the menu shown in Figure 2.21. At this screen, you basically enter the first Degree Wheel Reading, the Crank Degree Step size, and expected total duration for the lobe. A preview is given and a graphical representation of the span of degree wheel readings is drawn on a typical degree wheel.

First Degree Wheel Reading

Enter the first degree wheel reading on the opening ramp, usually this is for the first point about .001" above base circle.

Before/After TDC

Click on the down arrow key to select the degree wheel's notation of either Before or After Top Dead Center (TDC) or Bottom Dead Center (BDC). Check the Degree Wheel drawing to see if the pointer is drawn at the correct position.

Crank Deg Steps

Click on the down arrow button to select how many crank degrees between each cam lift measurement. The smaller this number the more readings required (if you are entering data by hand) or the more readings generated (if you are generating from the simple cam specs).

Estimated Duration

Click on the down arrow button to select the number of degrees you estimate you will measure on this cam lobe. You can always add more if you need to.

Deg. Wheel Type

Click on the down arrow button to select the type of degree wheel you will use for measuring the cam. A simple sketch will be made of the wheel to the right. The Deg. Wheel Type defaults to the type picked in the Test Setup menu. Should you change it in this screen, it is also changed in the Test Setup menu.

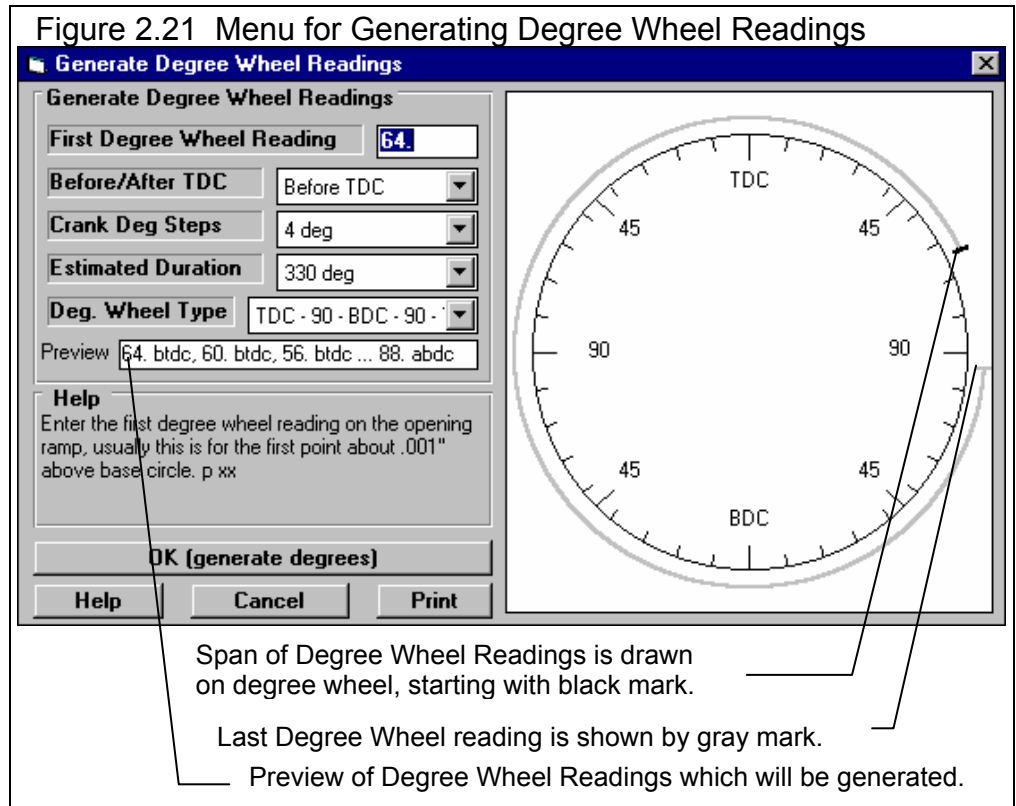

2.6 New Test Menu:

The New Test command is available by clicking on File at the top, left of the Main Screen, then selecting New Test. You will then be presented with the screen shown in Figure 2.22. Getting a new cam started right is very important for making the test accurate and easy. (Also see Example 4.1 for more details on the New Test menu.)

When starting a New Test, it is often best to first Open a previous cam which is similar to the New Test you will be running (similar cam specs, similar degree wheel, etc.) This previous cam will then be the 'pattern' or 'template' for the New Test and will save you from having to type in specs to describe this New Test. This also ensures consistency between your cams and reduces the possibility of errors.

If the current cam is not a good 'pattern' for this new cam (or if there currently is no cam displayed), you can abort starting this new test by clicking on 'Cancel (don't start new test)' at the top of the New Test screen. Then click on 'File' at the top, left of the Main Screen and select one of the 'Open' options to open a past test to serve as a pattern.

If you do start with a blank cam (which may be the case when you first get this program), or want to modify some specs from the previous cam by clicking on the 'See Specs' buttons for Test Setup. Click on Help at this menu for more info on how to enter these specs.

Figure 2.22 New Test Menu

4 Critical specs for the new test are listed here at the top.
Click here to start a New Test based on these settings.

These are the comments which you can modify. Uncheck Test Comments to start with blank comments for the New Test.

A summary of the current settings is given here.

Click on these buttons to see the current Test Setup.

Click here to Check or Uncheck these options. Checking means you want to keep these specs for the new test. Once the new test is started you can then make modifications to these specs if you want.

When you close out the Test Setup menu, you are brought back to the New Test screen. Most Test Setup specs can be changed once the test has started with no problems.

Four critical specs are listed separately at the top:

1. File Name for New Test is the file name the program will create for saving the Cam Data for the new cam you are starting. The program fills in a default name of the current cam name, but increments the last digit in the name by 1. You can change this name to most anything you like. The program will warn you if the name entered is not valid and show you what is wrong. See Section 3.5 for a descriptions of valid file names.
2. Operator for New Test is the name of the operator for this cam. Click on Pick to pick an operator name already used or to enter a new name. The program defaults to the operator of the current cam test.
3. Cam # for New Test is critical for shops who use a cam numbering system. Click on Assign to create a new Cam # based on the last Cam # assigned (incremented up by 1) or to start with a new type of Cam #. (If you want to type in most

anything you want for a Cam Number, or leave it blank, go to the Preferences menu and set Allow Direct Entry of Cam Numbers to No.)

4. Folder Name for New Test is the folder in the CAMDATA folder where the cam will be saved. The program may not be using the name 'folder' for this spec, but whatever word you have assigned in the Preferences menu at the Main Screen. The folder name 'Examples' is reserved for Performance Trends example cams supplied with the program, and can **NOT** be used for your cams.

When you are ready to start the new test, click on 'Start New Test' at the top of the screen. If some critical specs have not been entered, the program will warn you and ask you for them at that time. The program will fill in the Test Time and Date based on the computer's time and date. This can be changed later by clicking on the Test Time/Date at the Main Screen.

2.7 EZ Data Entry

This screen shows you EZ Data Entry screen which can save you considerable time and keep you from making mistakes when entering cam lift data. (Also see Example 4.1 for more details.)

Figure 2.23 Screen for EZ Data Entry

Click here to bring up the EZ Data Entry screen

Pick which data row from the Test Data grid you want to work with.

Click here to pick from all rows.

Click here to move up or down 1 row.

Type in a lift here, or watch the program fill in a lift when you click on the Estimate or Nudge buttons.

Click on these buttons (or use the key equivalents of the insert key, left arrow key and right arrow key) to quickly estimate the next cam lift, then nudge (adjust) it up or down to match the dial indicator.

The principle behind this screen is that if you can estimate a cam lift based on the previous 2 cam lift numbers. For example, if the previous cam lifts were .002 and .003, a reasonable estimate of the next cam lift would be .004. If you were setting at a blank row where the previous 2 rows had .002 and .003 as the cam lifts, you could click on the Estimate Next Lift button and the program would fill in .004. Now, if the dial indicator is actually showing .005, you can "Nudge" .004 up to .005 by clicking on the Nudge Up button twice (each click is .0005 inches).

Many times it is easier to press keyboard keys than repositioning the mouse and clicking on a particular button. The EZ Data Entry screen allows you to do this. See Figure 2.24. You can use the 4 arrow keys on the lower right side of the keyboard, plus the 0 (or insert) key from the number keypad also on the left side of the keyboard. These 5 keys let you do everything you need to do that the mouse can do in this screen. On laptops without a number keypad, the 0 key or Insert key will work as the 0 key on the number keypad.

The general EZ Data Entry procedure would consist of:

1. Pressing the Insert Key to estimate the lift for the current row based on the 2 previous rows
2. Pressing the left or right arrow keys to get the estimated lift to match the actual lift (Nudge up or down as necessary).
3. Pressing the down arrow key to advance to the next row.

4. Repeating steps 1 - 3.

Until you get used to this process, this may not seem any faster than typing in numbers. However, with a little practice you can save considerable time and avoid mistakes.

Notes:

If you have typed a cam lift number into the Lift box, the keys may not work until you click on a button with the mouse or choose a Data Point with the mouse.

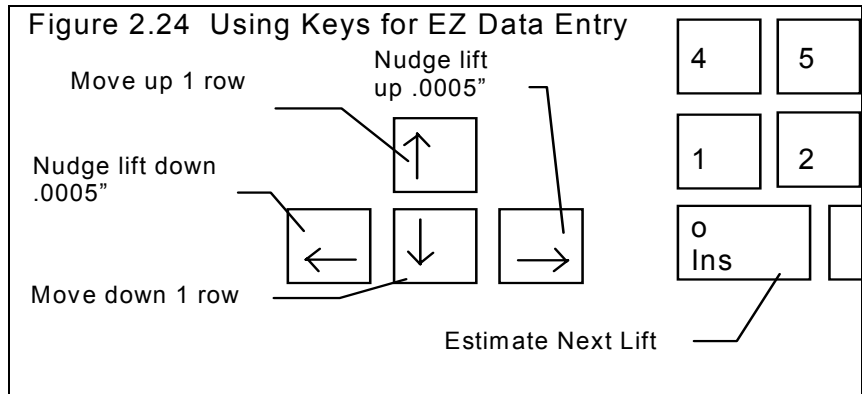

There must be accurate cam lifts already entered into the 2 rows before the current row for the program to accurately estimate the next cam lift. Therefore, this process works best if you start at the 3rd row of a lobe (after typing in the first 2 lifts) and work steadily through the entire lobe.

Menu Commands

Close

Closes this screen and returns you to the Main Screen.

Help

Brings up "on screen" help.

Chapter 3 Output

The Cam Analyzer provides several ways to view and output the cam results, including:

- Reports of tabular data displayed on the screen
- ASCII files for importing results to other software packages
- High resolution graphs
- Printer output of Reports or graphs
- History Log
- Data Libraries for recording cam data for later use.

All these topics will be covered in this chapter. Figure 3.1 shows how to reach all these various features.

Figure 3.1 Various Output Options from the Test Results Screen

Click on File to display several options to Save test files, Open test files which were previously saved, display the History Log, or print information.

Click on Graph to display several Graph Options and produce a high resolution graph.

Click on Report to display several Report Options and produce a tabular report. Once a report is displayed, it can be output as an ASCII file, or printed.

Name of current Test File

Open from History Log displays a chronological log of test files you have recently worked with (started new, opened, made graphs or reports of, etc.) Section 3.7.

Saving options to Save a test file are discussed in Section 3.5.

Opening options to open a previously saved test file are discussed in Section 3.5.

Although Print options are limited on the Main Screen, most menus have a Print button to print that menu, or a File command which lists Print options under it. See Section 3.4

3	56. BTDC	.006
4	52. BTDC	.009
5	48. BTDC	.013
6	44. BTDC	.018
7	40. BTDC	.025
8	36. BTDC	.032
9	32. BTDC	.041
10	28. BTDC	.050
11	24. BTDC	.061
12	20. BTDC	.074

3.1 Reports

Click on the Report menu command at the Main Screen to be presented with the Report Options Menu shown in Figure 3.2. The inputs in this menu are described below.

Also check Appendix 5, 6 for new report features.

Type

Several types of Reports can be picked by clicking on the down arrow key of this combo box. Depending on your choice, several options in this menu may be enabled or disabled. These types are discussed in upcoming sections.

- Report Lift
- Report Velocity
- Report Acceleration
- Report Jerk

Pick Yes for any of these 4 data types to be included in the report.

Lift is the Cam Lift data either kept as cam lift or converted to Valve Lift based on the specified lash and Rocker Arm Ratio in the Test Setup specs.

Velocity is the *rate of change* of lift, or the derivative of lift (in mathematical terms). The units are Inches per cam degree, or thousandths of inch per cam degree if you have set the Scaling spec in the Reports Menu to “Multiply Vel/Accel/Jerk by 1000”. For example, if the report shows Velocity is 1.377 and Scaling is set to “Multiply Vel/Accel/Jerk by 1000”, the actual velocity is .001377 inches per degree.

Acceleration is the *rate of change* of velocity, or the derivative of velocity (in mathematical terms). The units are Inches per cam degree per cam degree (inches/deg²), or thousandths of inch per cam degree per cam degree if you have set the Scaling spec in the Reports Menu to “Multiply Vel/Accel/Jerk by 1000”. For example, if the report shows Acceleration is .1377 and Scaling is set to “Multiply Vel/Accel/Jerk by 1000”, the actual acceleration is .0001377 inches per degree.

Jerk is the *rate of change* of acceleration, or the derivative of acceleration (in mathematical terms). The units are Inches per cam degree per cam degree per cam degree (inches/deg³), or thousandths of inch per cam degree per cam degree per cam degree if you have set the Scaling spec in the Reports Menu to “Multiply Vel/Accel/Jerk by 1000”. For example, if the report shows Jerk is .01377 and Scaling is set to “Multiply Vel/Accel/Jerk by 1000”, the actual jerk is .00001377 inches per degree.

For some Report Types, like a Duration Report, these specs are not needed and are disabled (dimmed to gray and you can not change them).

Table 3.1 Units of Measure for Cam and Valve Data

Data Type	Units of Measure (for Scaling set to “Don’t Mult Vel/Accel/Jerk by 1000”) *
Lift	inches
Velocity	inches/cam degree
Acceleration	inches/cam degree/cam degree (inches/cam degree ²)
Jerk	inches/cam degree/cam degree/cam degree (inches/cam degree ³)

* If you set “Multiply Vel/Accel/Jerk by 1000” to Yes, then inches are turned in thousandths of an inch.

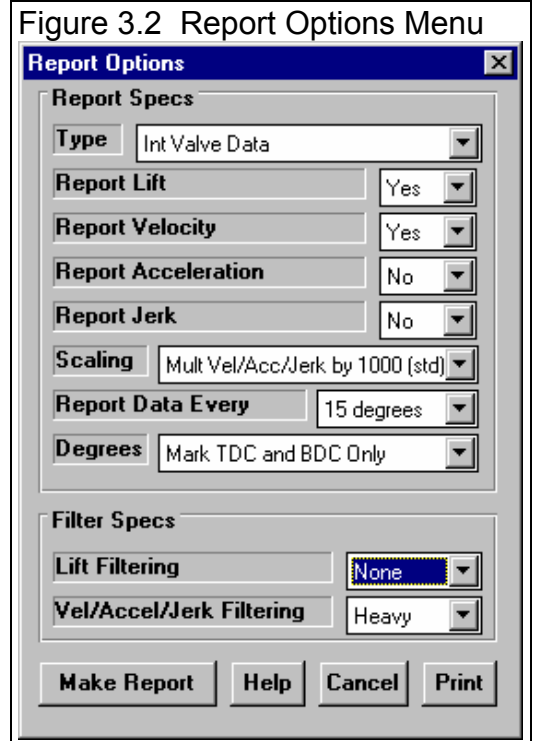

Scaling

Select "Mult Vel/Accel/Jerk by 1000" and the Velocity, Acceleration and Jerk values are multiplied by 1000, so they are more similar to the lift numbers. Select "Don't Mult Vel/Accel/Jerk" and they are reported in actual inches/deg, inches/deg², or inches/deg³.

Report Data Every

Click on the down arrow key of this combo box. to pick how often to report data. The smaller the number, the more detailed and longer the report.

Degrees

Click on the down arrow key of this combo box. to pick how the degrees should be labeled for the report.

1. Mark TDC and BDC where only top and bottom dead center are marked. All other degrees are labeled in universal degrees (0 - 720).
2. Mark like Degree Wheel where degrees are marked like the degree wheel you see on the Main Screen. This can be very confusing should you choose to export this data as an ASCII file.
3. Mark all as numbers (ie 60-720) where all degrees are marked in universal degrees. This is the best choice should you want to export this data as an ASCII file.

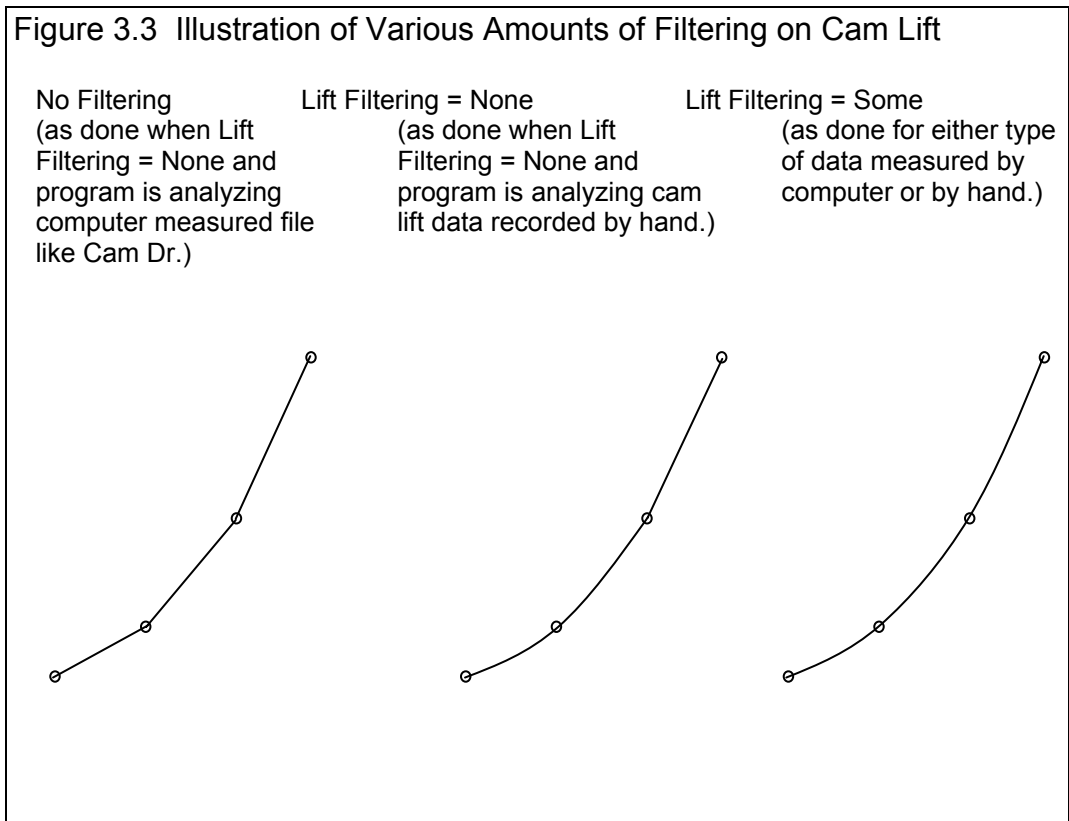

Filter Specs

Lift Filtering

Cam analysis almost always requires various amounts of filtering or smoothing of measured data. That is because minor measurement errors exist in the cam lift or crank degree measurements, even those done with very precise instruments. The effect of these small measurement errors are greatly magnified when velocity, acceleration, and jerk calculations are made.

Figure 3.3 gives some idea of how the lift curve and data would look with various amounts of filtering. Note that Figure 3.3 is somewhat exaggerated so the idea of filtering can be seen.

Choose None, and the cam lift data entered by hand is only smoothed one time. Cam lift data from computerized cam measurement systems (like a Cam Dr file) is not smoothed. (Precise computerized measurements may not require additional smoothing.) Choosing None for computerized cam files may be necessary to more accurately see what the computerized cam measurement systems actually measured, or to find defects measured in the actual cam lobe.

By choosing Some, the program will perform additional filtering (smoothing) of the cam lift profile. This additional filtering will be barely noticeable in the lift graphs or reports. However it does have a significant impact on calculated velocity, acceleration and jerk. Figure 3.4 shows how additional filtering also smoothes out the acceleration curves. For this reason, additional filtering is always recommended when a Cam Dr (tm) file is created.

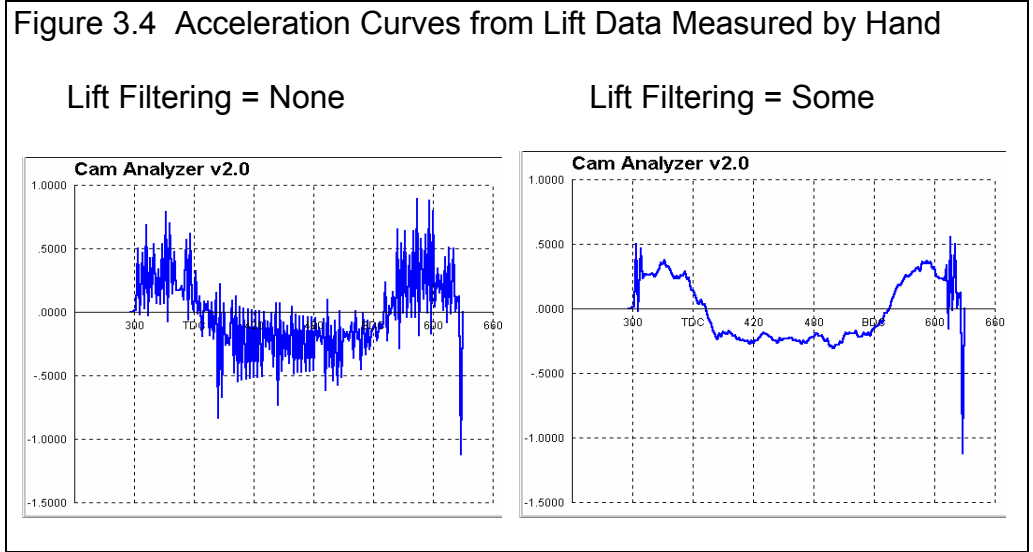

The advantages of additional filtering include:

- Filtering can reduce the effect of minor measurement errors.
- The resulting cam lift profile (and velocity and acceleration) should be more like what the cam grinder *intended* to grind.
- You can preview the cam profile created when you make a Cam Dr file.

The disadvantages to additional filtering include:

- Additional calculation time is required for reports and graphs.
- Possibility of "smoothing over" some real defect in a cam profile. See Figure 3.5.

Vel/Accel/Jerk Filtering

This combo box lets you add additional filtering (smoothing) to only the velocity, acceleration and jerk data. Usually, these data types require at least Some filtering, with Moderate and Heavy required sometimes with Acceleration and usually with Jerk. Figure 3.4 shows the effect of additional filtering on Velocity and Acceleration.

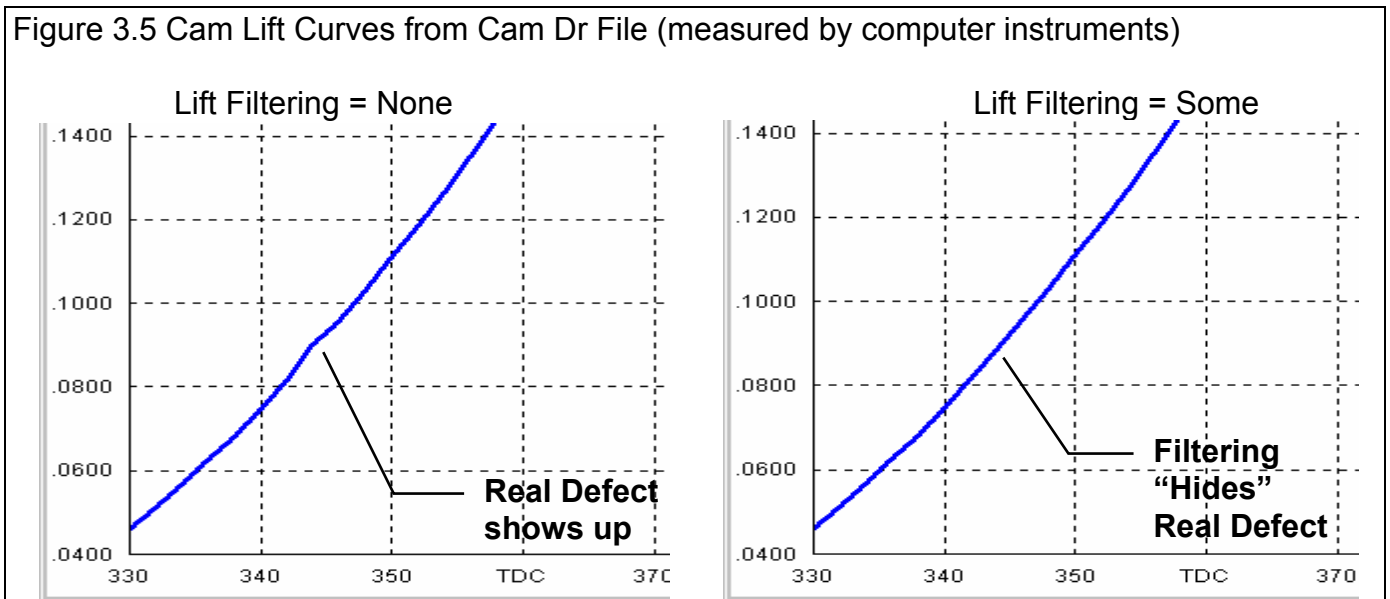

As a “rule of thumb”, you want to use the minimum filtering available that still produces relatively smooth data graphs. Do NOT over-filter by specifying more filtering than you need.

Figure 3.18 (page 55 in the Graph section) shows some roughness in Acceleration when Filtering = None, however Velocity looks good. Setting Filtering = Moderate definitely smoothed out the Acceleration graph, but perhaps too much. Velocity is probably *over-filtered*. Figure 3.18 shows that the Velocity data is probably most accurate with Filtering = None, and the Acceleration data would probably be best with Filtering = Some.

Table 3.2 Recommended Filtering

Type of Data Graphed	Recommended Vel/Accel/Jerk Filtering
Velocity	None, sometimes Some
Acceleration	Some, sometimes Moderate
Jerk	Moderate to Heavy

Report Types

Int & Exh Cam Data

Int Cam Data

Exh Cam Data

Int & Exh Valve Data

Int Valve Data

Exh Valve Data

These reports let you pick the type of data (lift, velocity, acceleration and/or jerk) to be included in the report. See Figure 3.2, page 41. The data can be for the intake lobe, exhaust lobe or both; and for either valve data or cam data. Cam results will be very similar to the Cam Lift data you measured, and similar to most computerized cam checking results. Valve data will use the Rocker Arm Ratio and lash specs (no lash if the Type of profile is specified as hydraulic) settings in the Test Setup and Cam Specs menu. Valve lift is calculated from cam lift as follows:

$$\text{Valve Lift} = (\text{Cam Lift} \times \text{Rocker Arm Ratio}) - \text{Valve Lash}$$

Figure 3.6 Portion of Int & Exh Data Report

Report of: Cam Data Test Time: 10:21 AM 03/05/1994 Events Plotted at .050" Tappet Lift

CLine	Dur	Open	Close	Lb Area	Lb Lift	Vlv Lift	RRR	Lash	LbSep/Adv	Overlap
Int: 101.8	258.9	28.3	50.6	37.60	.436	.653	1.5	.026	107.1	47.1
Exh: 112.3	260.4	61.5	18.8	37.73	.434	.651	1.5	.028	5.2 Advance	

Int Crank Degrees	Int Cam Lift, inches	Int Cam Vel, in/dg x 1000	Int Cam Acc, in/dg^2 x 1000	Int Cam Jrk, in/dg^3 x 1000	Exh Crank Degrees	Ex inc
296	.0000	.0000	.0000	.000000	85	.0f
300	.0044	1.1395	.1879	-.117918	90	.0f
305	.0071	1.6224	.228	-.05709	95	.0f
310	.0114	2.1758	.2534	-.022591	100	.0f
315	.0175	2.8365	.2645	-.011517	105	.0f
320	.0251	3.5062	.2855	-.013854	110	.0f
325	.0348	4.2399	.2955	-.009454	115	.0f
330	.0459	4.9557	.3026	-.004182	120	.0f
335	.0591	5.6557	.2993	.003459	125	.0f
340	.0745	6.3640	.2861	.012614	130	.0f
345	.092	7.0186	.2602	.019710	135	.1f
350	.1106	7.6207	.2304	.024467	140	.1f
355	.1306	8.1185	.1932	.031547	145	.1f
TDC	.1524	8.5026	.1417	.039931	150	.1f
365	.1752	8.7476	.0855	.047959	155	.1f
370	.1983	8.8516	.0158	.054460	160	.2f
375	.2214	8.8227	-.0524	.053398	165	.2f
380	.2445	8.6534	-.1115	.046955	170	.2f
385	.2669	8.3736	-.1692	.035001	175	.2f

Annotations in the image:

- Summary of Critical specs for this test and head. (points to the header table)
- The data you selected to report appears in columns with the name of the data in this top row. (points to the table headers)
- Click on Report Types to bring up the Reports Option menu again to change a report option. (points to the 'Report Types' menu)
- Select either Print option to print this report (points to the 'Print' button)

Int & Exh Raw Data

This Report simply restates the raw data recorded on the Test Data grid for each lobe. If you select this Report all specs in the Reports menu are disabled. Generally, raw data is only useful for finding errors in data which occurred during the cam measurement test. For example, during analysis of data, one data point looks "out of line" from the others. By examining the raw data, you may discover that a lift was entered as .233 when it should have been .223.

Int & Exh Duration Int Duration Exh Duration

These Report types display the duration of the lobe at various lift points. The lifts the program uses for determining lifts are at every .050" of cam lift starting at .050" up to .500". In addition, there are 6 lifts which the user can specify in the Preferences menu, discussed in Section 2.2 on page 19. Usually these are lower lifts like .006, .020, etc. These are lifts which may be used for valve lash, and which may be used by a particular cam grinder to advertised durations.

Note that these are *cam* lifts. If you want to check a particular *valve* lift, you must divide by rocker arm ratio. For example, to check .030" valve lift (like .030 valve lash), you would check .020" (.030 / 1.5 = .020).

Figure 3.7 Portion of Int & Exh Duration Report

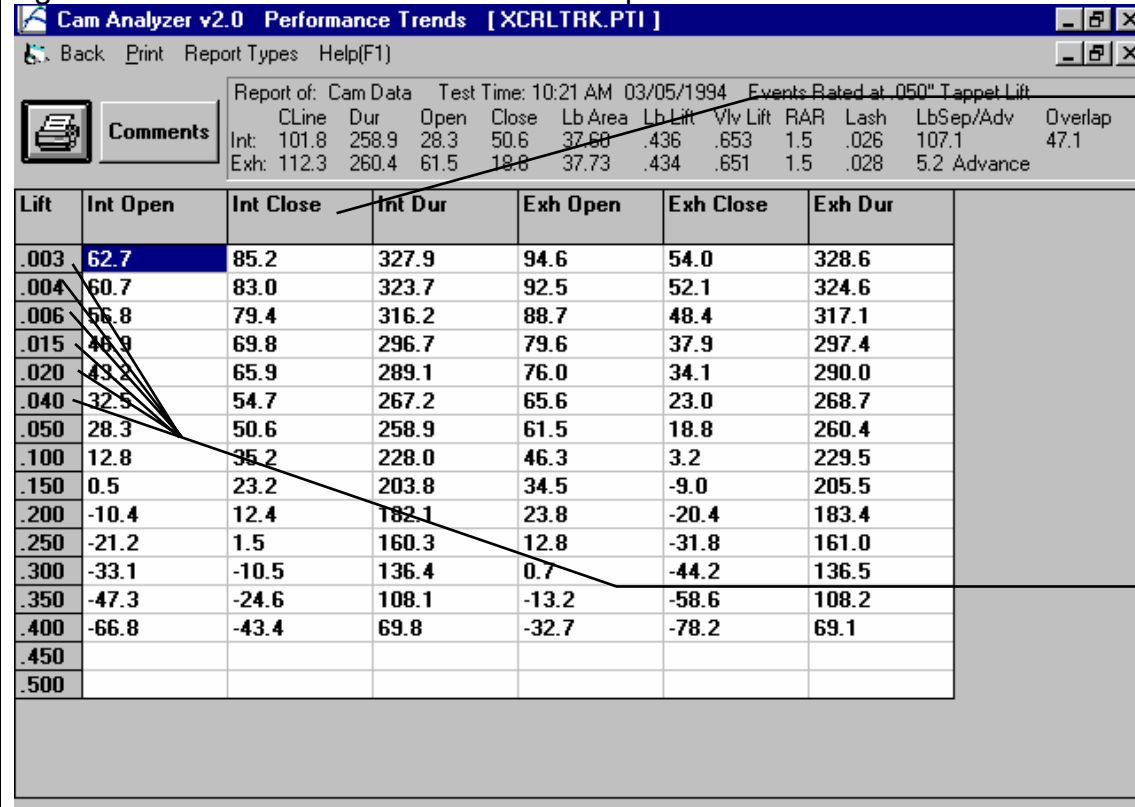

This Report shows opening and closing events and duration at various lifts.

These lower lifts for checking duration and events can be set in the Preferences menu.

Int & Exh Lobe Area
Int Lobe Area
Exh Lobe Area

This Report contains Lobe Area measurements in addition to a simple duration measurement. Lobe area is defined in Figure 3.8, and is the "Area Under the Cam Lift Curve". For example, a roller with more aggressive opening and closing ramps will have more Lobe Area than a gentler flat tappet cam, even though they have the same duration at .050" and max lift.

Int & Exh LArea+Dur Report
Int LArea+Dur Report
Exh LArea+Dur Report

These types of report basically combine the outputs from the Duration and Lobe Area reports. See Figure 3.10.

Figure 3.8, Definition of Lobe Area

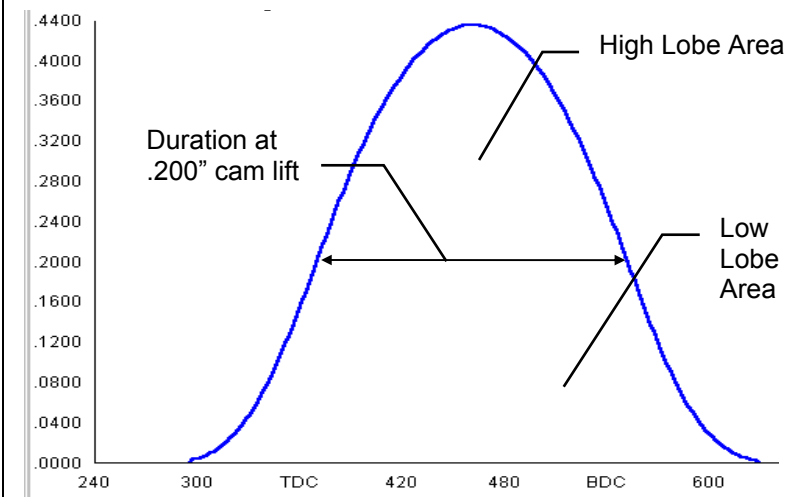

Duration is measured in Crank Degrees
 Lobe Area is measured in Cam Degrees x Cam Lift, or Degree x Inches

Figure 3.9 Lobe Area Report

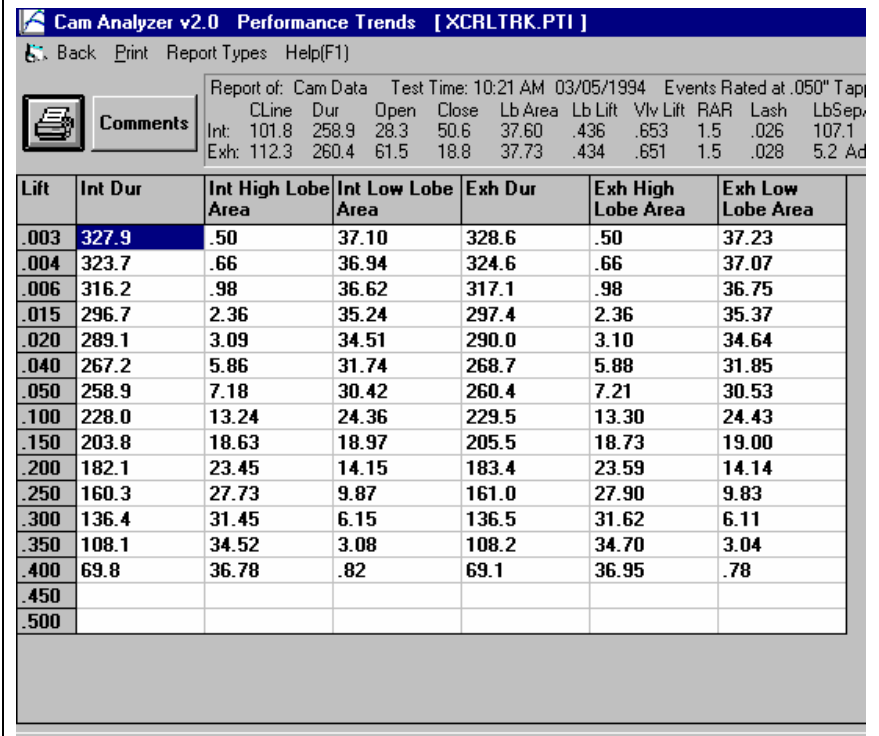
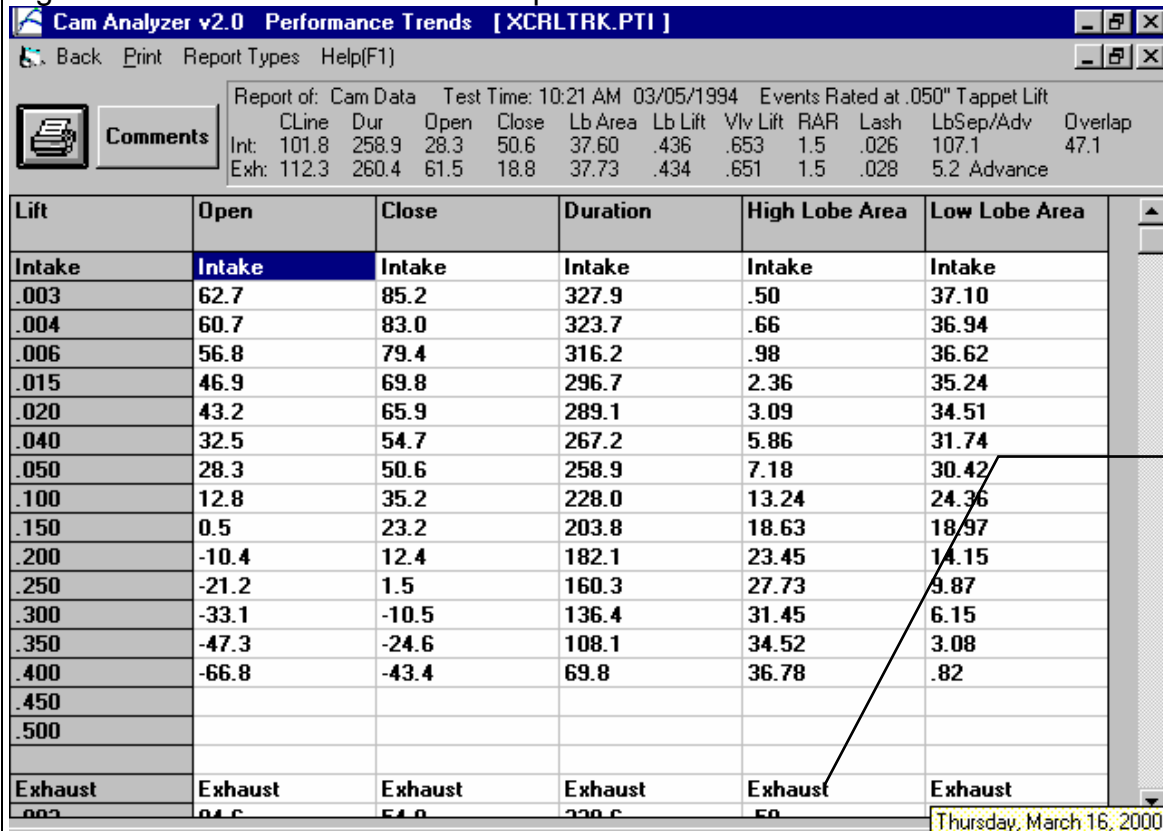

Figure 3.10 Int & Exh LArea+Dur Report



Note that the exhaust data comes at the end of this report, not on the right side of the report as in other reports.

3.2 ASCII Data Files

You may want to use the results from the Cam Analyzer in other software packages. This could be for additional graph capabilities, statistical analysis, data basing, etc. Once you have created a Report (as shown in Section 3.1), click on File to write the results to an ASCII file with a name of your choosing. The ASCII File command is possible any time a Report is displayed on the screen.

You can only save the results currently displayed on the Report screen. If you want to write an ASCII file of a cam file you have previously run, you must open that cam file at the Main Screen first, then create a Report for that cam file.

Note: ASCII files can be of several different formats and most will not be readable by programs expecting computer files from Cam Drs or Cam Pro Plus measurement systems. These file formats are very specific and must be created by the measurement system software. Cam Dr files can be created by the Cam Analyzer and are discussed in Section 3.8.

Versions 3.8 and 4.0 have added features for ASCII files. Check Appendix 5 and 6.

ASCII File Options

Comma Separated

Select this option to insert commas between data points. Leave this unchecked for data to be arranged in evenly spaced columns.

Include Text

De-select (uncheck) this option to strip out all titles and letters, leaving only numbers.

Convert to Columns

If you do not select this option, data will be written to the file much like it is displayed in the Report on the screen. Select this option to have the Report turned on its side, that is, the rows will become columns and the columns will become rows.

File Name

Enter a file name for saving this ASCII file. Checks are made to ensure what you enter is a valid file name and that you are not overwriting an existing file. The file is written to the Cam Analyzer folder (directory), the folder which contains the CA.EXE program file.

There are certain limitations for file names, including:

- Names can only be 11 characters long.
- Names can not contain certain characters, like commas (,), plus signs (+), or spaces (.). The program will warn you if you use an illegal character.

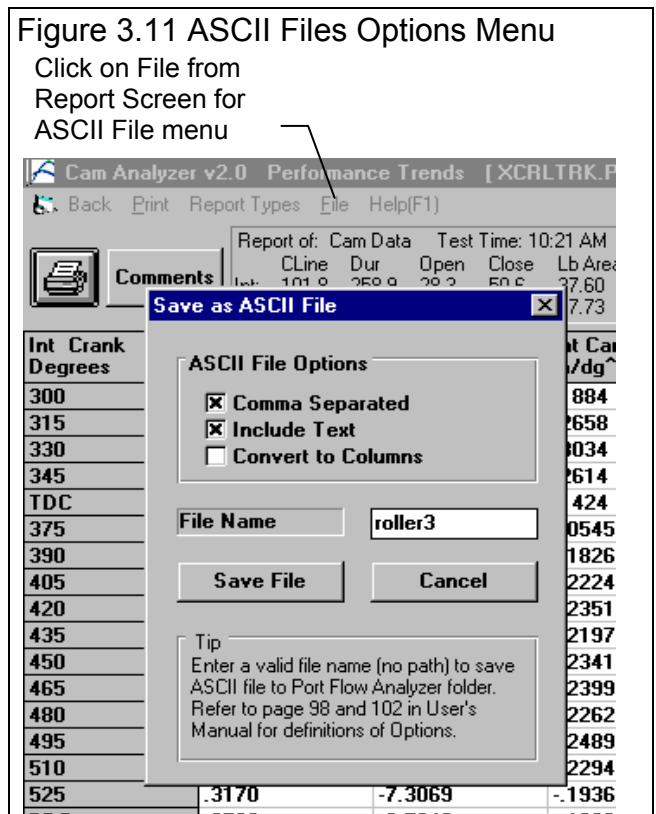

- Only 1 period (.) can be used and it can only be toward the end of the file name. The program will warn you if you use a period in the wrong spot.

See Section 3.5 for more details on file names

3.3 Graphs

Graphs are obtained by clicking on the Graph menu command at the top of the Main Screen or clicking on the Summary Graph at the Main Screen. Figure 3.12 shows a typical graph and descriptions of some of the basic graph screen items.

Check Appendices 3 - 7 for several recently added graph features.

Figure 3.12 Primary Graph Screen Items

Command buttons. Some commands can only be done through these buttons, some of these buttons just provide a graphical button for performing action of some menu items.

Menu bar provides for several graph commands and options.

Graph Title, which can be changed by clicking on Format, then Edit Titles/Legend.

Name of current Test File containing all flow data and specs

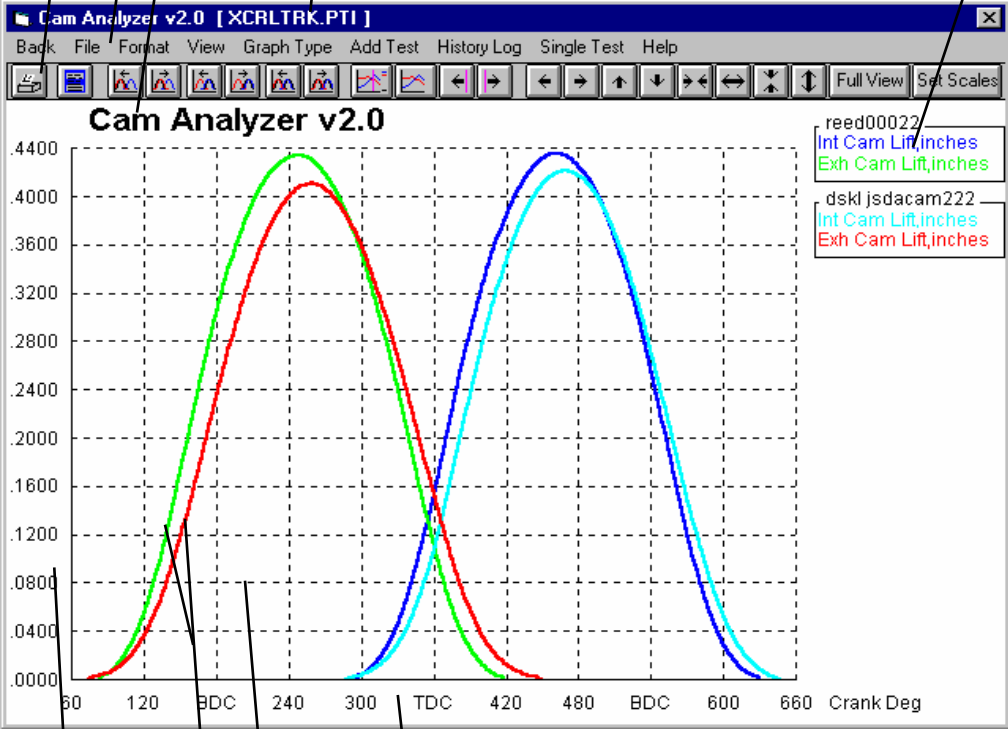

The screenshot shows the Cam Analyzer v2.0 interface. At the top is a menu bar with 'Back', 'File', 'Format', 'View', 'Graph Type', 'Add Test', 'History Log', 'Single Test', and 'Help'. Below the menu bar is a toolbar with various icons. The main window title is 'Cam Analyzer v2.0 [XCRLTRK.PTI]'. The graph area displays two cam lift curves: a red curve for 'reed00022' and a blue curve for 'dskl jsdacam222'. The Y-axis is labeled from 0.0000 to 0.4400 in increments of 0.0400. The X-axis is labeled 'Crank Deg' and ranges from 60 to 660 with major ticks every 120 units and labels for BDC and TDC. A legend on the right side of the graph lists the data series: 'reed00022 Int Cam Lift,inches' (blue), 'Exh Cam Lift,inches' (green), 'dskl jsdacam222 Int Cam Lift,inches' (red), and 'Exh Cam Lift,inches' (cyan). Annotations with lines pointing to the interface include: 'Command buttons' pointing to the toolbar; 'Menu bar provides for several graph commands and options.' pointing to the menu bar; 'Graph Title, which can be changed by clicking on Format, then Edit Titles/Legend.' pointing to the window title; 'Name of current Test File containing all flow data and specs' pointing to the file name in the title bar; 'Graph Legend, which describes the data graphed. This includes Name of the Test Results file, Type of Data, which data goes with which file, if any multiplier is applied to the data. You can also click on Data Type names and the corresponding data line will flash. This is useful to find a particular line when several are graphed. In the Pro version, names in the Legend can be changed by clicking on Format, then Edit Titles/Legend.' pointing to the legend box; 'Horizontal X axis. The scaling of this axis can be easily changed as described in this section.' pointing to the X-axis label; 'Grid lines. The style or elimination of grid lines can be changed by clicking on Format, then Grid Style.' pointing to the dashed grid lines; 'Data graph lines. The style and thickness of these lines can be changed by clicking on Format, then Line Style.' pointing to the cam lift curves; and 'Vertical Y axis. The scaling of this axis can be easily changed as described in this section.' pointing to the Y-axis label.

Graph Legend, which describes the data graphed. This includes Name of the Test Results file, Type of Data, which data goes with which file, if any multiplier is applied to the data. You can also click on Data Type names and the corresponding data line will flash. This is useful to find a particular line when several are graphed. In the Pro version, names in the Legend can be changed by clicking on Format, then Edit Titles/Legend.

Horizontal X axis. The scaling of this axis can be easily changed as described in this section.

Grid lines. The style or elimination of grid lines can be changed by clicking on Format, then Grid Style.

Data graph lines. The style and thickness of these lines can be changed by clicking on Format, then Line Style.

Vertical Y axis. The scaling of this axis can be easily changed as described in this section.

There are 2 basic types of data which can be graphed:

- **Cam Data** like cam lift, cam acceleration, etc.
- **Valve Data** like valve lift, valve acceleration, etc.

For these 2 data types, you can select intake and or exhaust lift, velocity, acceleration and jerk; and various scaling and filtering options, which are set in the Graph Options menu. See Figure 3.13.

Graph Type

Several types of graphs can be picked by clicking on the down arrow key of this combo box to select Intake, Exhaust or both for graphing Cam or Valve Data.

Graph Lift

Graph Velocity

Graph Acceleration

Graph Jerk

Pick Yes for any of these 4 data types and that data will be included in the graph.

Lift is the Cam Lift data either kept as cam lift or converted to Valve Lift based on the specified lash and Rocker Arm Ratio in the Test Setup specs.

Velocity is the *rate of change* of lift, or the derivative of lift (in mathematical terms). The units are Inches per cam degree.

Acceleration is the *rate of change* of velocity, or the derivative of velocity (in mathematical terms). The units are Inches per cam degree per cam degree (inches/deg²).

Jerk is the *rate of change* of acceleration, or the derivative of acceleration (in mathematical terms). The units are Inches per cam degree per cam degree per cam degree (inches/deg³).

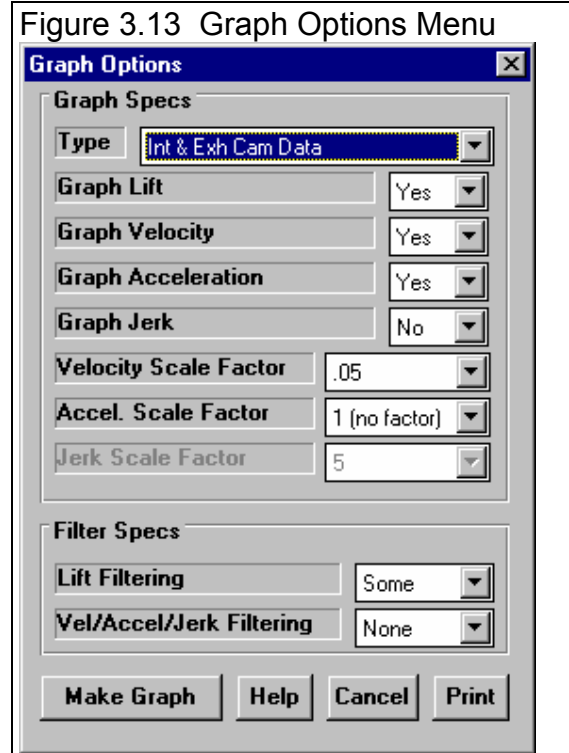

Table 3.3 Units of Measure for Cam Data

Data Type	Units of Measure
Lift	inches
Velocity	inches/cam degree
Acceleration	inches/cam degree/cam degree (inches/cam degree ²)
Jerk	inches/cam degree/cam degree/cam degree (inches/cam degree ³)

Velocity Scale Factor

Acceleration Scale Factor

Jerk Scale Factor

Click on these combo boxes to pick the number by which velocity, acceleration or jerk will be multiplied by. If you pick 1 (no change), then these data types will be graphed exactly as they are calculated, which is quite small compared to lift. See Figure 3.14. If you are only graphing, say velocity, it is usually best to select a Scale Factor of 1 (no change). Then you can read the velocity directly off the graph. However, if you include velocity with valve or cam lift, then a multiplier of 20 to 100 works well. Table 3.4 shows some recommendations for Scale Factors.

Table 3.4 Recommended Scale Factors

Data Type	Recommended Scale Factor When Graphing with Lift Also
Velocity	50
Acceleration	100
Jerk	500

Figure 3.14 Effect of Velocity Scale Factor

Velocity x 50 shows up well

Velocity x 1 (no factor) does not show up

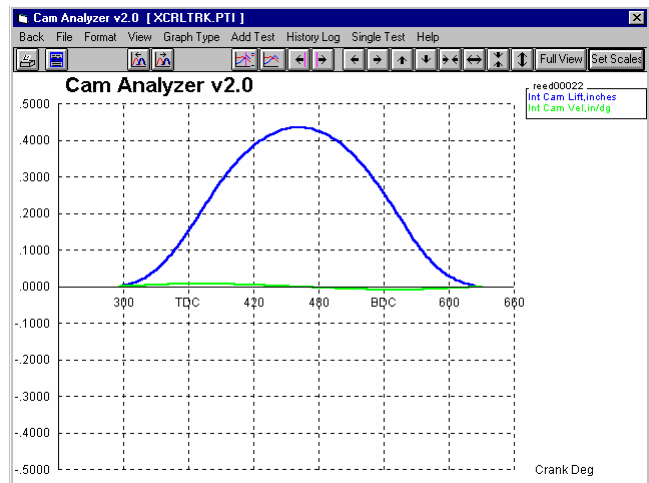
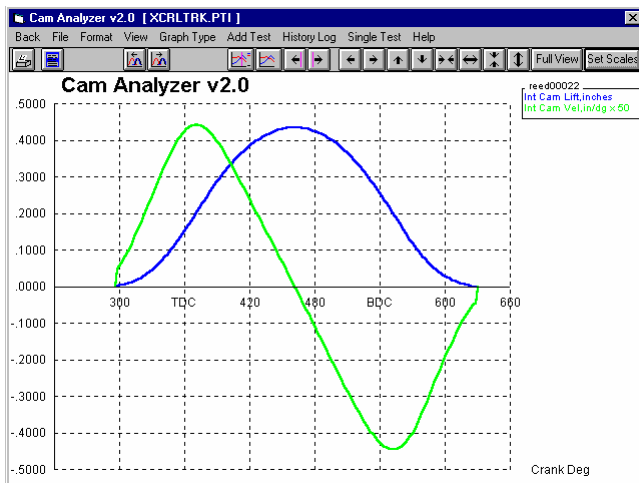

Filter Specs

Lift Filtering

Cam analysis almost always requires various amounts of filtering or smoothing of measured data. That is because minor measurement errors exist in the cam lift or crank degree measurements, even those done with very precise instruments. The effect of these small measurement errors are greatly magnified when velocity and acceleration calculations are made.

Figure 3.15 gives some idea of how the lift curve and data would look with various amounts of

Figure 3.15 Illustration of Various Amounts of Filtering on Cam Lift

No Filtering
(as done when Lift Filtering = None and program is analyzing computer measured file like Cam Dr.)

Lift Filtering = None
(as done when Lift Filtering = None and program is analyzing cam lift data recorded by hand.)

Lift Filtering = Some
(as done for either type of data measured by computer or by hand.)

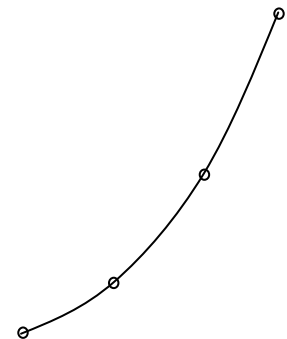
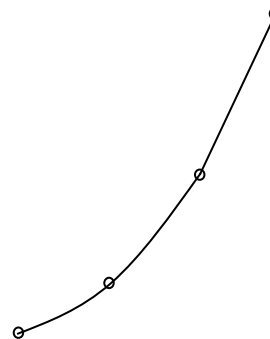
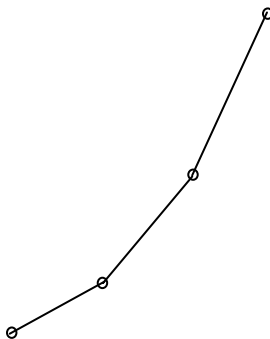

filtering. Note that Figure 3.15 is somewhat exaggerated so the idea of filtering can be seen.

Choose None, and the cam lift data entered by hand is only smoothed one time. Cam lift data from computerized cam measurement systems (like a Cam Dr file) is not smoothed. (Precise computerized measurements may not require additional smoothing.) Choosing None for computerized cam files may be best so you can more accurately see what the computerized cam measurement systems actually measured, or to find defects measured in the actual cam lobe.

Figure 3.16 Acceleration Curves from Lift Data Measured by Hand

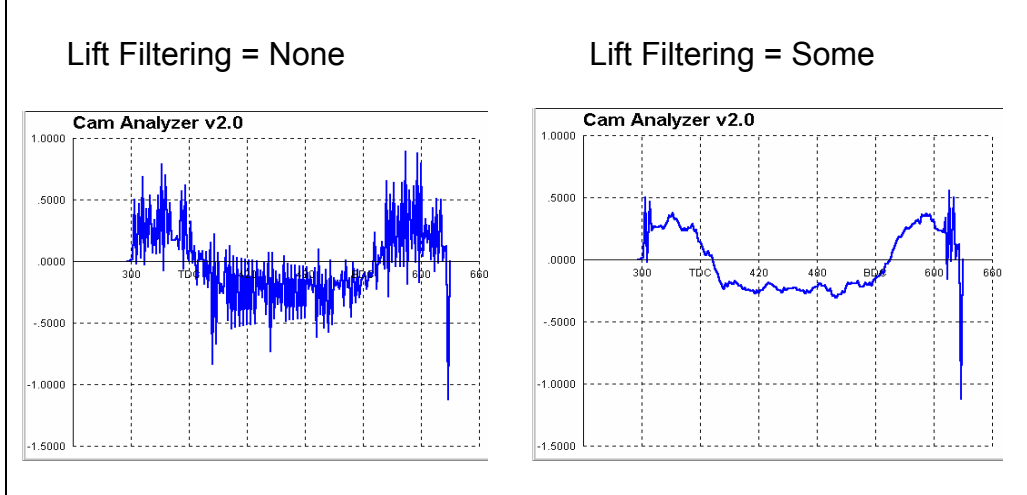
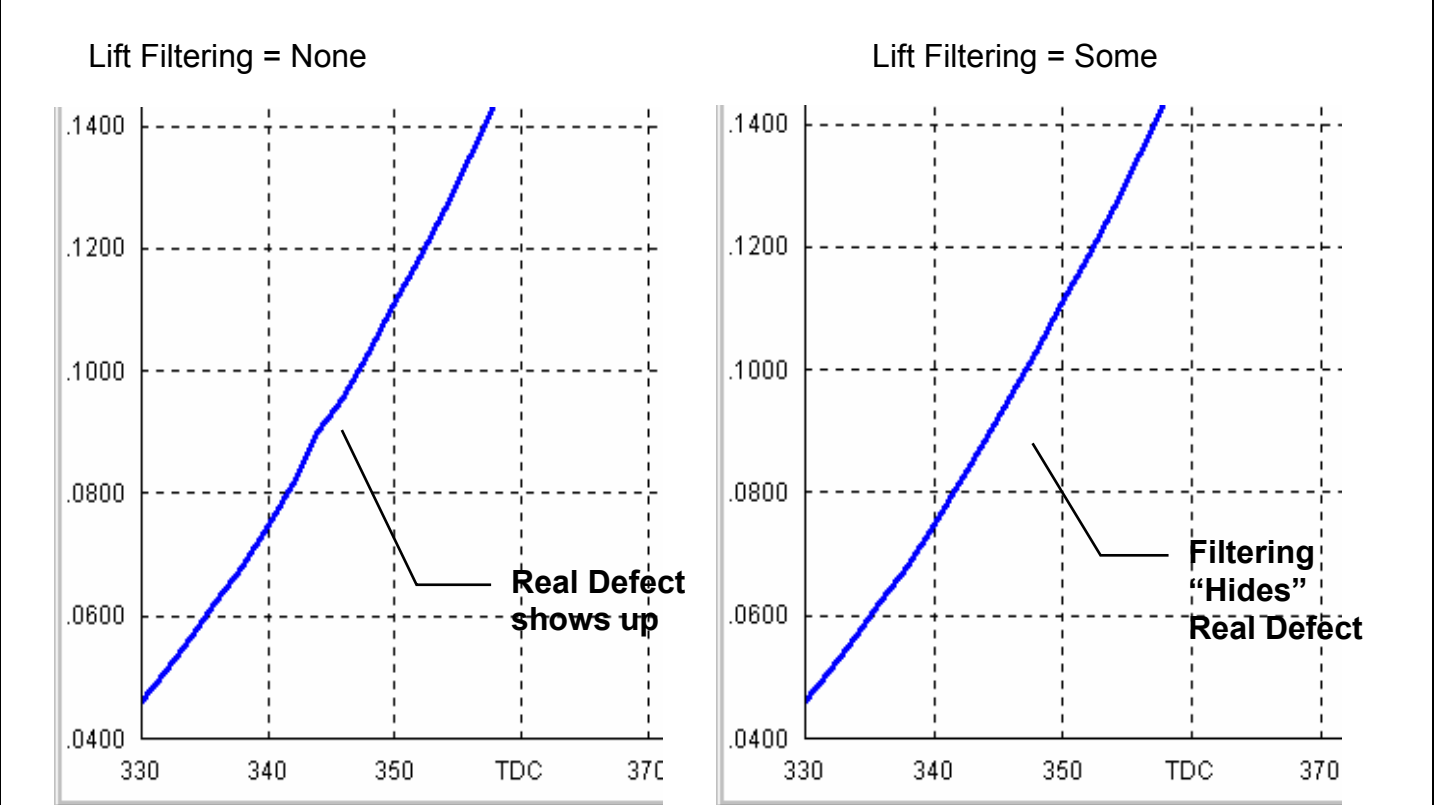

Figure 3.17 Cam Lift Curves from Cam Dr File (measured by computer instruments)



By choosing Some, the program will perform additional filtering (smoothing) of the cam lift profile. This additional filtering will be barely noticeable in the lift graphs or reports. However it does have a significant impact on calculated velocity, acceleration and jerk. Figure 3.16 shows how additional filtering also smoothes out the acceleration curves. For this reason, additional filtering is always recommended when a Cam Dr (tm) file is created.

The advantages of additional filtering include:

- Filtering can reduce the effect of minor measurement errors.
- The resulting cam lift profile (and velocity and acceleration) should be more like what the cam grinder *intended* to grind.
- You can preview the cam profile created when you make a Cam Dr file.

The disadvantages to additional filtering include:

- Additional calculation time is required for reports and graphs.
- Possibility of "smoothing over" some real defect in a cam profile. See Figure 3.17.

Vel/Accel/Jerk Filtering

This combo box lets you add additional filtering (smoothing) to only the velocity, acceleration and jerk data. Usually, these data types require at least Some filtering, with Moderate and Heavy required sometimes with Acceleration and usually with Jerk. Figure 3.18 shows the effect of additional filtering on Velocity and Acceleration.

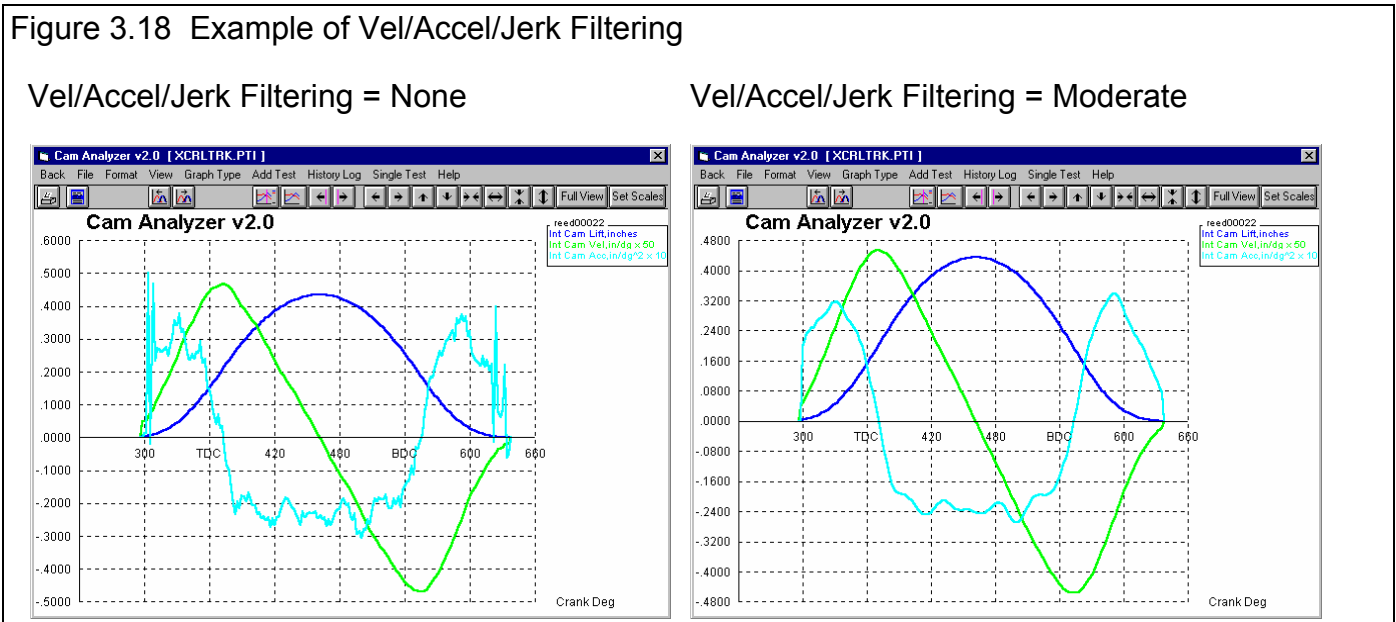

As a “rule of thumb”, you want to use the minimum filtering available that still produces relatively smooth data graphs. Do NOT over-filter by specifying more filtering than you need.

Figure 3.18 shows some roughness in Acceleration when Filtering = None, however Velocity looks good. Setting Filtering = Moderate definitely smoothed out the Acceleration graph, but perhaps too much. Velocity is probably definitely *over-filtered*. Figure 3.18 shows that the Velocity data is probably most accurate with Filtering = None, and the Acceleration data would probably be best with Filtering = Some.

Table 3.5 Recommended Filtering

Type of Data Graphed	Recommended Vel/Accel/Jerk Filtering
Velocity	None, sometimes Some
Acceleration	Some, sometimes Moderate
Jerk	Moderate to Heavy

Graphs Comparing More Than 1 Test

There are 3 basic types of *cam files* which can be graphed:

- **Current cam results.** These are the cam results of the cam file which you are working with on the Main Screen.
- **Tests marked in the History Log.** These are the cam results which you previously graphed, started new, opened, etc. which you have marked "Yes" to graph in the History Log (see Section 3.7).
- **Add Test** lets you pick any cam from the Test Library to add to the top of the History Log, and mark as a cam you want to graph. Since it is at the top of the History Log, it should definitely be included in the next graph.

You can compare data from up to 6 cams, as long as there is room for the Legends (labels) for each graph on the right side of the graph. Usually this ends up being about 24 graph lines, which could be 6 cams with 4 graph lines (for example, Int & Exh Valve Lift and Valve Acceleration).

Figure 3.19 History Log (See Section 3.7 for more details.)

Click on the History Button or the History menu item to display the History Log.

Click on Single Test to graph only the Current Test.

Click on Add Test to pick a new test to add to the graph to the History Log from the entire Test Library.

Choose a 'Graph' option from the menu bar to close the History Log and graph the tests identified by the menu option you pick.

Click in 'Graph?' column to select or de-select tests for graphing. Slide button right for more History info. (Dur. meas. at .050".)

Click in this column to show Yes or remove Yes. Tests marked Yes will be graphed, if there is room (typically not more than 24 graph lines total).

This column shows the Standard name the program will display in graph Legend for this test. Click on the name to change it. Alternate names are possible by clicking on Format, then Edit Titles.

Click and drag slide bar to display entire History Log. Some tests marked Yes may be at the bottom of the Log and not be visible now.

Test File and Path	Graph?	Std Graph Title	Save?	Cam #	Int Lift	Dur	Test Date
\examples\xcrltrk.pti	Yes	reed00022		Reed00022	.436"	258.4	03/05/1994
\examples.new\xdrag.pti		compcam00457		CompCam00457	.470"	279.7	02/07/1994
\examples.new\xcrltrk.pti		reed00022		Reed00022	.436"	258.4	03/05/1994
\examples.new\ud6060-s.r07		ultradyme00344		UltraDyne00344	.436"	258.4	03/05/1994
\examples.new\cc8094-s.r04		compcam00457		CompCam00457	.470"	279.7	03/13/2000
\examples\cc8094-s.r04	Yes	cc8094-s.r04			.470"	279.7	04/06/1994
\my-tests\cam-mark.cp3		dsk\isdacam222			"		03/06/2000
\examples\boss302-e2		cam000347			"		06/13/1994
\examples\560609h8.cp1		cam000347			"		06/13/1994

Other Graphing Features

The graph screen has several other features, including:

- Printing
- Cursor to pinpoint the value of a particular point on the graph
- Changing titles and legend names
- Changing the scales
- Shifting (advancing/retarding) lobes with respect to each other

These are discussed in this next section.

Printing

Figure 3.20 shows the options for printing graphs and how to access these options. Figure 3.21 shows the screen for changing the Windows Printer Setup. Figure 3.22 shows how you can add information to a graph printout by clicking on Format, then Edit Printed Comments and Data Output.

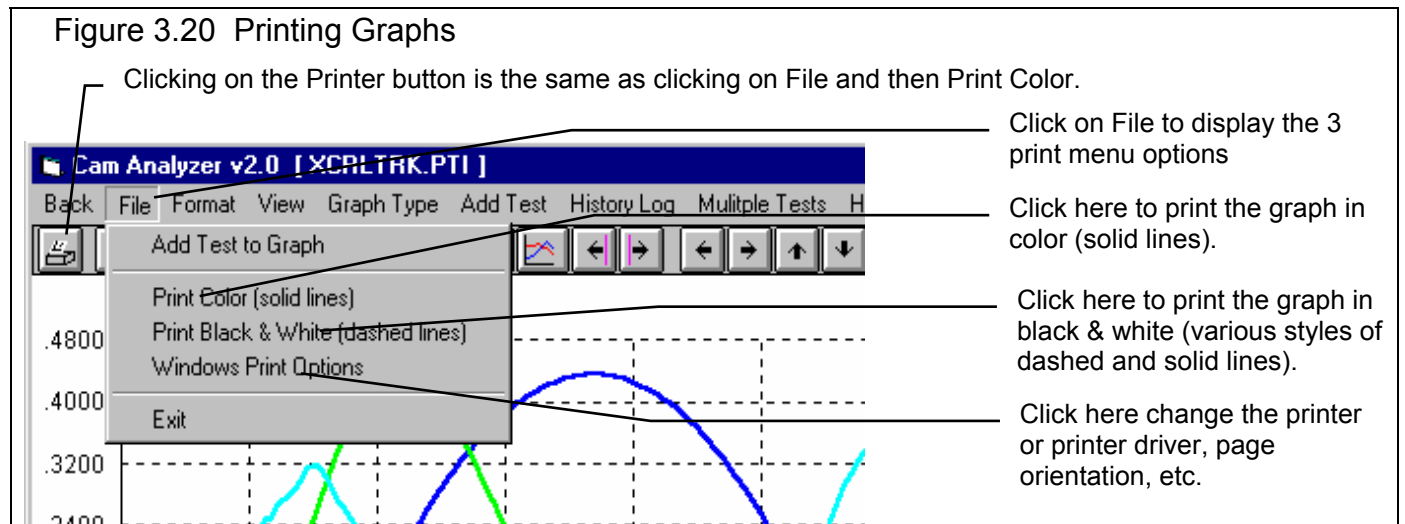

Figure 3.21 Standard Windows Printer Options

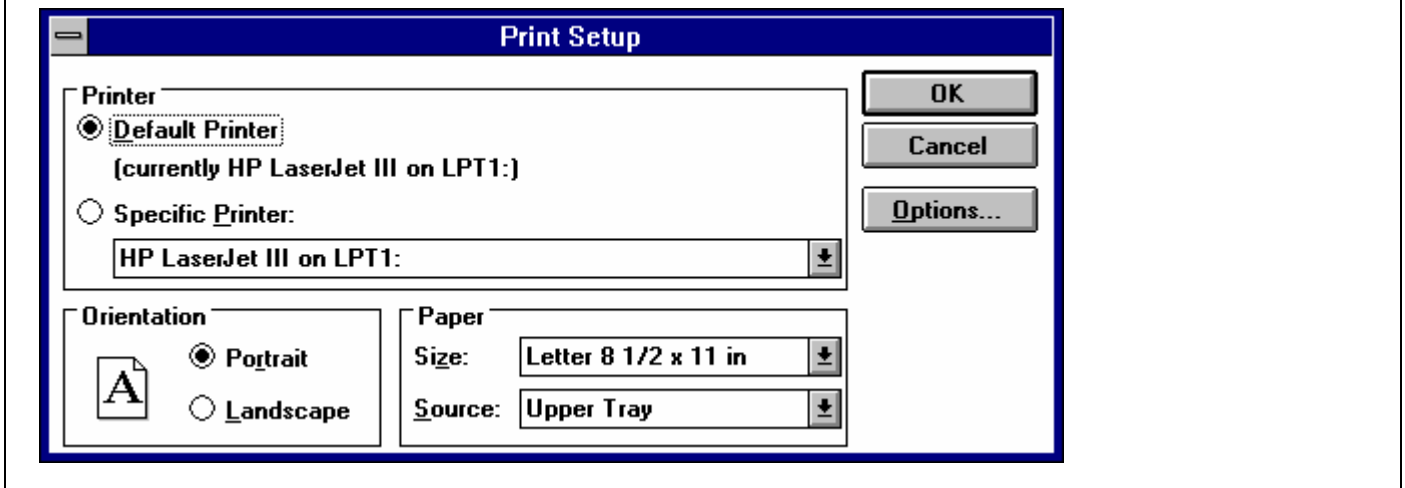

Figure 3.22 Adding Information to a Graph Printout . (Most of these options have no effect on the graph on the screen, only the graph that is printed.)

Click on these #s to change which Data Set's (test file's) comments and title you are working with.

Click here to change the Test Comments (comments which appear on the Main Screen). Changes to Data Set 1's comments (the current test) are permanent. Changes to other Data Set's comments are temporary.

This one comment is printed directly under the graph.

The Titles to Use options give you a way to reach the Menu in Figure 3.24 to change the Titles and Legends of the graph.

Check or uncheck these 3 options to determine what gets printed, and what options are enabled and disabled on this screen.

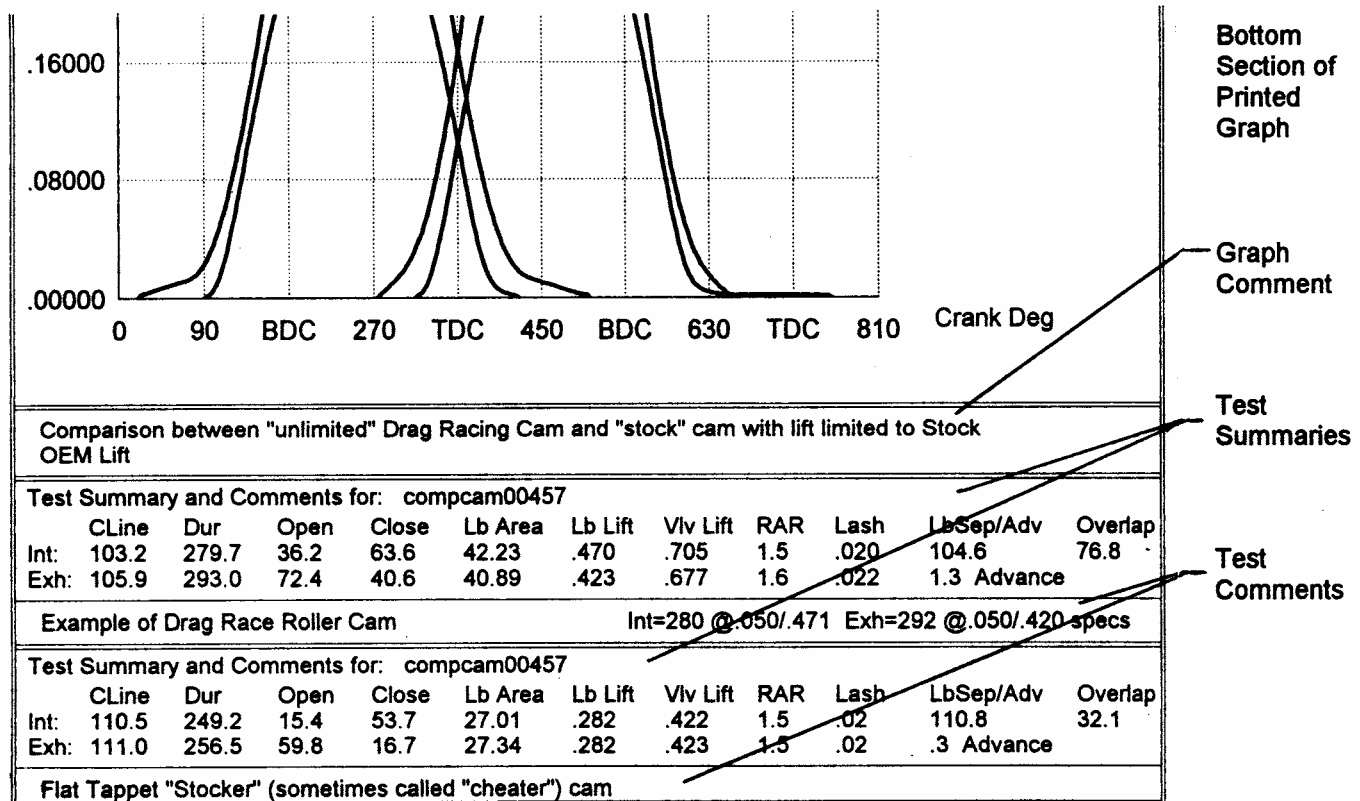

Cursor

The cursor feature is very useful for determining or comparing the value of the graph lines at various places. See Figure 3.23 for explaining the use of the cursor.

Figure 3.23 Cursor Features and Commands

Cursor line, usually pink or green, depending on background color.

Click here to turn cursor ON.

Click here to turn cursor OFF.

Click on these buttons to move the cursor left or right. Hold down the <shift key> while clicking these buttons and the cursor moves faster. You can enable the cursor by clicking on View, then Turn Cursor On.

The value of each graph line at the cursor is displayed here.

The X value of the cursor is shown here, in this case the Crank Degrees of 390.

You can also enable the cursor by single clicking on a graph line **at a data point**. This also provides a quick way to move the cursor from 1 area of the graph to another. (Do not drag the mouse while clicking or you will zoom in on that area.)

The screenshot shows the 'Cam Analyzer v2.0' window with a menu bar (Back, File, Format, View, Graph Type, Add Test, History Log, Multiple Tests, Help) and a toolbar. The main graph area displays three data series: a blue line for lift, a green line for velocity, and a cyan line for acceleration. A vertical green cursor line is positioned at 390 degrees on the x-axis. A data readout box in the top right corner shows the following values: 'read00022', 'Int Cam Lift,inc 2875', 'Int Cam Vel,inc/ .008074', and 'Int Cam Acc,inc/ -.00019'. The x-axis is labeled 'Crank Deg' and has major ticks at 300, TDC, 420, 480, BDC, 600, and 660. The y-axis ranges from -4800 to 4800 with increments of 800.

Changing titles and legend names

Many times you may want to customize a graph by displaying and printing labels of your choice. Click on Format and then Edit Titles/Legend to bring up the menu shown in Figure 3.24 which will allow you to do this.

Figure 3.24 Menu to Edit Title and Legend

This is the list of Standard names the program uses unless you click on the Use New Titles button below. Select (click on) a Standard name you want to change. The Standard Name appears in the edit box, along with the current New name if there is one. **Once you have selected a name from this list (that row will be highlighted) it is easier to use the up and down arrow keys to select the next item to edit than clicking the item with the mouse.**

This is the list of New names the program will use if you click on Use New Titles. If a title in the List of New Names is blank, the program will use the Standard name.

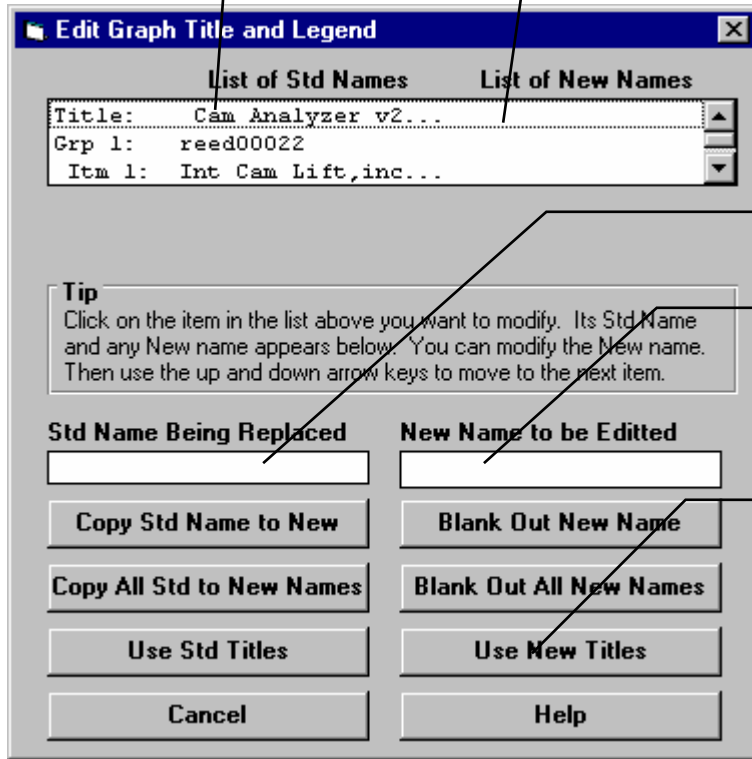

Standard name from row selected.

New name for you to edit. Other options include clicking on the Copy Std Name to New or Blank Out New Name buttons.

Click here to close this menu and use the New names you have entered. Where New names have been left blank, the Standard name will be used.

Changing the scales

Many times you may want to change the scale of the X or Y axis. This may be to show an area in more detail or to match the scales of a previous graph. The Pro has several ways to change the scales as shown in Figures 3.25 and 3.26.

Figure 3.25 Changing Scales for the X or Y Axis

Clicking on these buttons shifts the graph left, right, up or down. Hold down the shift key while clicking on them and the graph moves farther each step.

Clicking on these buttons zooms in or zooms out on the graph, either vertically or horizontally. Hold down the shift key while clicking on them and the graph moves farther each step.

Click here to restore "auto-scaling". That is where the computer picks the scale to show all the graph in good detail.

You can use the mouse to outline an area to be zoomed in on. Simply click on the mouse key in the upper left corner of the area, then hold the key down and drag the mouse to the lower right corner of the desired area. A box will be drawn as shown. When you release the mouse key, this area will fill the whole graph. This feature is disabled if the cursor is turned on. Also, start the upper left corner well away from a graph line or the program may turn on the cursor instead.

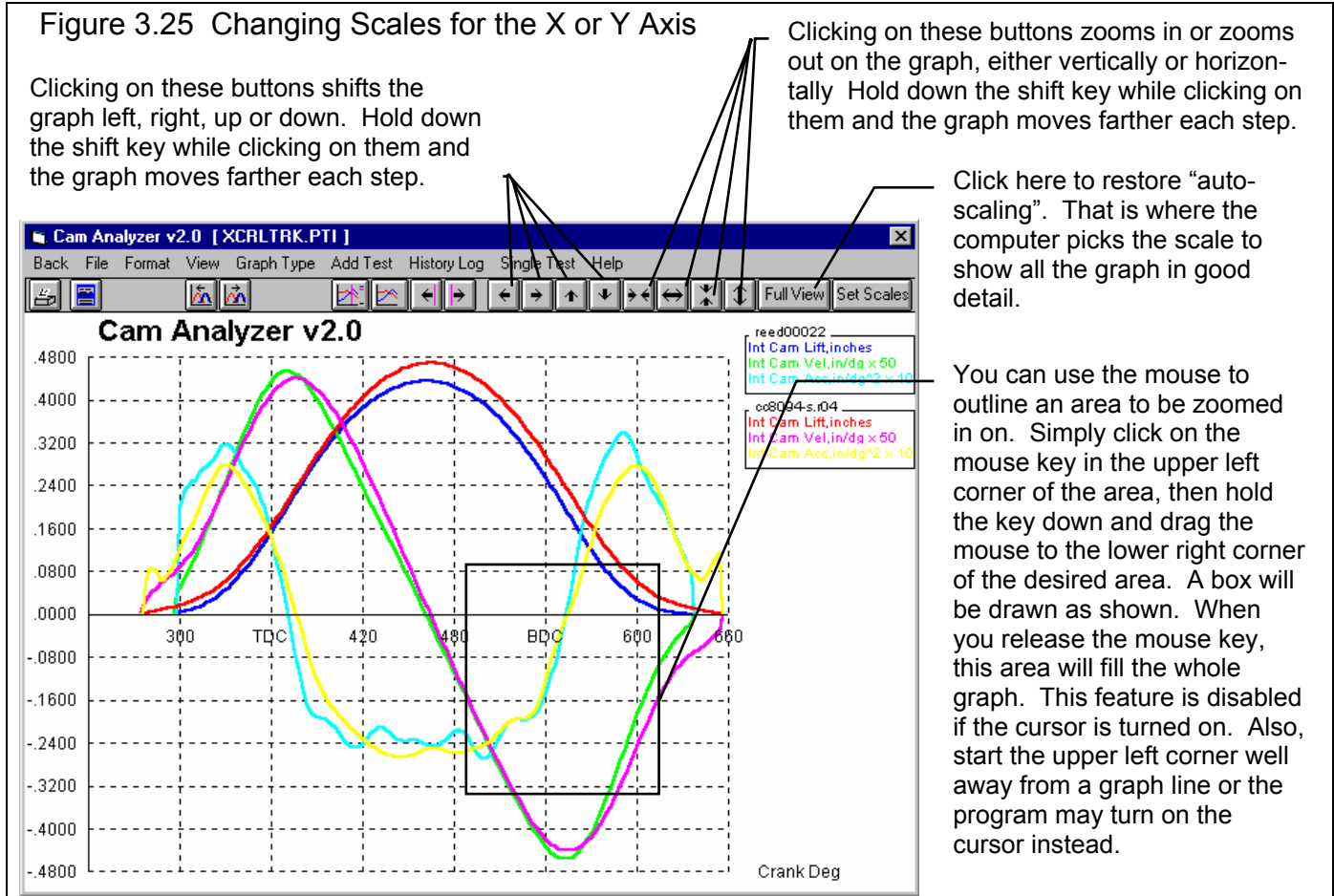
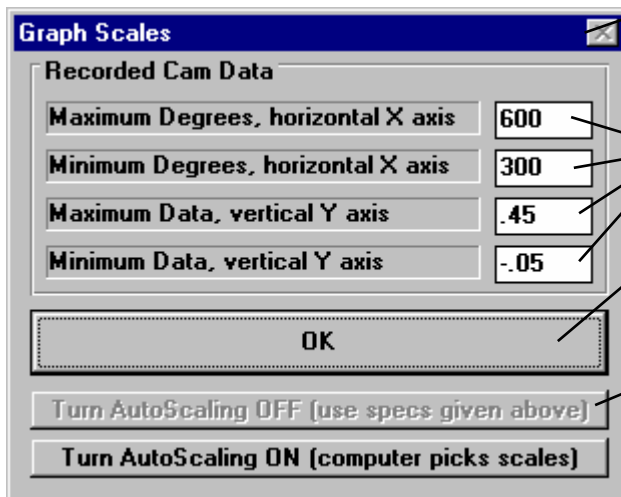

Figure 3.26 Menu to Specify Graph Axes Scales



This menu can be obtained 2 ways. You can click on View in the menu bar then Specify Scales (axes), or click on the Set Scales button, the right most button on the graph screen.

The current scale limits are loaded when this menu opens. Change any or all these to most any value you want.

Click on OK to have the graph redrawn to these new scale limits.

Click the Turn AutoScaling Off button to turn AutoScaling Off to enable changing specs in this menu. (Its shown disabled here because it has already been turned Off)

Shifting (advancing/retarding) Graphs

Many times you may want to realign 1 graph with respect to another, for example to line up centerlines or velocity peaks, etc. The Cam Analyzer allows you to shift (advance or retard) one or any lobe on the graph, as shown in figure 3.27.

Figure 3.27 Showing Options to Shift (advance/retard) Data from 1 File Over Another File

The figure consists of three screenshots of the Cam Analyzer v2.0 software interface, illustrating the process of shifting cam data.

Top Screenshot: Shows the main graph with two cam profiles. The y-axis represents lift in inches (0.0000 to 4.8000) and the x-axis represents Crank Degree (0 to 630). Annotations include:

- Left side: "Click here to shift Exhaust lobe to left (advance it).", "Click here to shift Exhaust lobe to right (retard it).", "Click here to shift Intake lobe to left (advance it).", "Click here to shift Intake lobe to right (retard it)."
- Right side: "Click here to shift Exhaust and Intake lobes together to left (advance entire cam).", "Click here to shift Exhaust and Intake lobes together to right (retard entire cam)."

Middle Screenshot: Shows the same graph with shifted lobes. Annotations include:

- Right side: "To switch to a different file, click on one of the graph data tvnes for that file" (pointing to the file name).
- Right side: "The file you are shifting is highlighted by printing the name in bright pink." (pointing to 'reed00022').
- Right side: "The number of degrees each lobe has been shifted is displayed here." (pointing to '4 ret' and '6 ret').

Bottom Screenshot: Shows the 'View' menu open. Annotations include:

- Right side: "Click on View for other Shift options." (pointing to the View menu).
- Right side: "Click here to show the amount you have shifted each" (pointing to 'Show Adjusted Cam Timing').
- Right side: "Click here to return the graph to its 'unshifted' original condition. Note that the program remembers the amount of shifting for the displayed lobes until you close the graph screen, open the History Log, or pick different file(s) to graph." (pointing to 'Show Original Cam Timing').
- Right side: "Click here to zero out the amount of shifting you have done." (pointing to 'Reset Cam Timings to Original Timing').

3.4 Printer Output

The Cam Analyzer can print the tabular cam results of a Report for a permanent hardcopy by clicking on Print in the menu bar or the Printer icon. The menu of options shown in Figure 3.28 will appear. Check the options you want to use for the printout by clicking on any or all of the Option boxes. All options and buttons are discussed in this section.

Figure 3.28 Printer Button and Print Menu Command Options - Report Screen

Click on Print or the Printer button (shown hidden here) for the Printout Options menu shown to the right.

This options lets you choose the printer or printer driver being used by Windows and also page orientation.

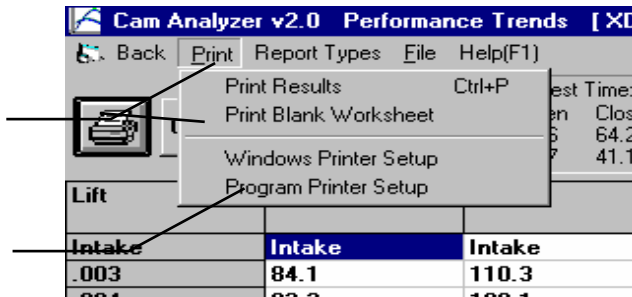

Check or uncheck these options, then click on this button to print the current report with these options.



Check or uncheck these options, then click on this button to print a blank paper worksheet. This worksheet can be useful for recording data when your engine can not be next to your computer.

Test Results Report Options

- Include Cam Number, Operator
- Include Test Conditions
- Include Test Comments
- Request Report Comment

Select these options if you want all the specs from these menus printed with the Report. This may add 1-2 pages to the printed Report.

Include Test Comments

Select this option if you want all the comments for the Test File printed with the results.

Request Report Comment

Select this option if you want to be asked for a comment for each particular Report you send to the printer. These "Report comments" are useful to identify important points for future reference, like modifications, engine results, etc.

Larger Font (Print Size)

Check this option if your particular printer is printing the results with a small print font. This option will increase the font size for some parts of some Reports. Also see Preferences for Selecting Printer Fonts, page 26.

Worksheet Options

These options let you print a blank paper worksheet. This worksheet can be useful for recording data when your engine, dial indicator and degree wheel setup can not be next to your computer.

Stock Cam (260 degree duration)

Perf Cam (360 degree duration)

Race Cam (500 degree duration)

Check the option which best match the cam you will measure. The only problem with estimating a larger cam than you have is that the printout may be longer than you need and you may waste some paper.

Larger Space Between Lines

Select this option if you want more space between lines, so you can write your numbers larger.

Ask for Worksheet Comment

Select this option if you want to be asked for a comment for to be printed at the top of your worksheet.

Other Print Options

Other menus have print menu commands or print buttons as shown in Figures 3.29 and 3.30.

Figure 3.29 Print Commands in History Log

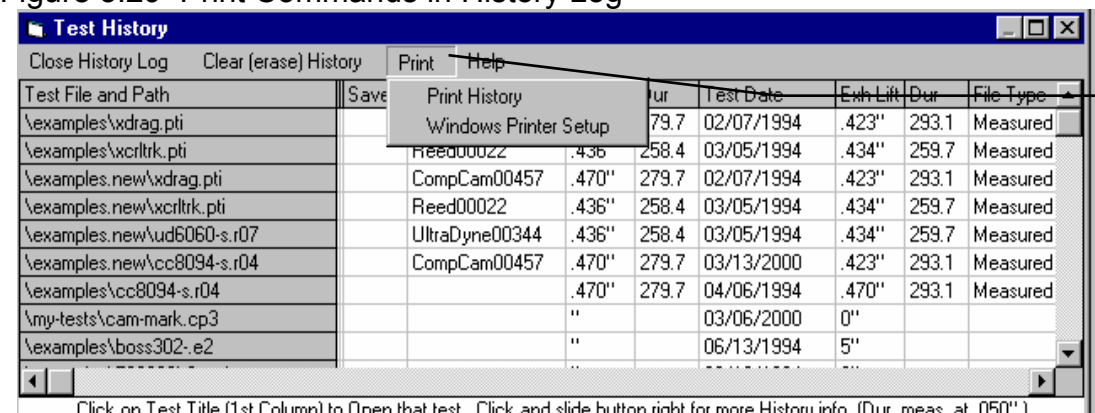

The screenshot shows a window titled "Test History" with a menu bar containing "Close History Log", "Clear (erase) History", "Print", and "Help". A table lists test files and their parameters. The "Print" menu is open, showing "Print History" and "Windows Printer Setup".

Test File and Path	Save	Dur	Test Date	Exh Lift	Dur	File Type
\examples\wdrag.pti		.79.7	02/07/1994	.423"	293.1	Measured
\examples\wcrltrk.pti		.436	03/05/1994	.434"	259.7	Measured
\examples.new\wdrag.pti		.470"	02/07/1994	.423"	293.1	Measured
\examples.new\wcrltrk.pti		.436"	03/05/1994	.434"	259.7	Measured
\examples.new\ud6060-s.r07		.436"	03/05/1994	.434"	259.7	Measured
\examples.new\cc8094-s.r04		.470"	03/13/2000	.423"	293.1	Measured
\examples\cc8094-s.r04		.470"	04/06/1994	.470"	293.1	Measured
\my-tests\cam-mark.cp3		"	03/06/2000	0"		
\examples\boss302-e2		"	06/13/1994	5"		

Click on Test Title (1st Column) to Open that test. Click and slide button right for more History info. (Dur. meas. at .050".)

Click on Print to display these Print Options.

Figure 3.30 Print Button

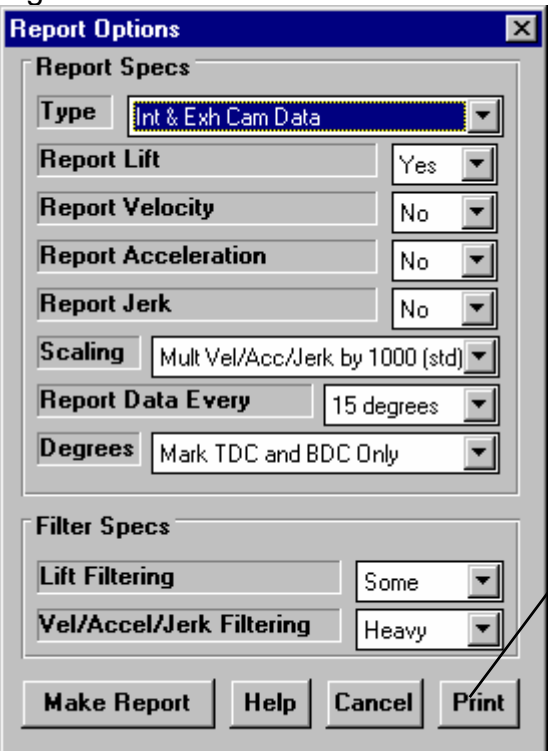

The screenshot shows a dialog box titled "Report Options" with sections for "Report Specs" and "Filter Specs". The "Print" button is highlighted with a callout line.

Report Specs

- Type: Int & Exh Cam Data
- Report Lift: Yes
- Report Velocity: No
- Report Acceleration: No
- Report Jerk: No
- Scaling: Mult Vel/Acc/Jerk by 1000 (std)
- Report Data Every: 15 degrees
- Degrees: Mark TDC and BDC Only

Filter Specs

- Lift Filtering: Some
- Vel/Accel/Jerk Filtering: Heavy

Buttons: Make Report, Help, Cancel, Print

Many screens and menus have a Print button. Click on it to print that particular screen or menu.

3.5 Data Libraries

Check Appendix 6 for new features for opening and Filtering (finding) files.

The Cam Analyzer allows you to save a set of Cam Data and related specs (Test Setup and Cam Specs, etc) to the Test File Library under a name of your choosing. You can then open these cam files out of the Test File Library in the future for comparison or modification. The Open window is below with explanations.

Figure 3.31 Test Library Options

Click on File, then Open (from all saved tests) to display Test Library shown here.
 Click on File, then Save or Save As to save current test and specs to the Test Library.

Total # Tests in Library under this Folder

Name of chosen Test (currently highlighted in Test List)

Click and drag slide bar to view all Tests in list

Preview of Test chosen

Single click on a Test to choose it for preview. Double click to immediately open it.

Tests can be saved under various categories (folders) to help you organize large #s of tests. Click on a different name here and a different list of Test Files will be displayed. The name "Folder" can be changed in the Preferences menu to most any word.

Click here to delete the chosen Test.

Click here to bring up standard Windows File Open screen, to let you open a file in most any folder (directory) and disk drive. See Figure 3.32 B.

Click here to bring up "on screen" help.

Click here to close the Test Library with No changes (without opening a test)

Click here to open the chosen Test

Select one of these options to list the test files alphabetically, either by test file name, or by cam #. This option can save you time looking for a particular test file.

Open a Test File

To open a cam file saved in the Test Library, click on File at the upper left corner of the Main Screen, then on the Open (from all saved cams). You also have an additional option of “Open (from History Log)” which will be discussed in Section 3.7.

You will obtain the window shown on the previous page. Single click on one of the cams in the list, or click and drag the slide button on the right side of the list to display more cams. Once you single click on a cam, it is now the Chosen Test File and a preview of the cam is given in the Preview section. If the file you chose was *not* a valid Cam Analyzer file (either Windows v2.0 or the older v1.1 for DOS), or *not* another cam file format the program recognizes (Cam Dr, Cam Pro Plus, etc.) the program will tell you and you can *not* choose it. See Section 3.6 on Opening Other Cam File Formats.

Once a cam has been chosen, you can delete it by clicking on the Delete button, or Open it by clicking on the Open button in this window. You can also click on a different cam to Preview it or close this window and return to the Main Screen without choosing a new cam file.

If you are sure of the cam you want to open, you can simply double click on it from the Test List. This opens the cam without a preview and closes this menu.

Save a Test File

Before you discuss saving a cam file, it is important for you to understand how the program opens and uses cam files. When you open a cam from the Test Library, you are only using a *copy* of the cam. The original cam file is kept in the library.

As you make changes to the cam, they are only made to this copy. The original file is not changed. If you want to delete your changes, you can simply open a fresh, unchanged copy of the original cam file from the Library. If you want to keep your changes, *you must save them*. This can be done by clicking on File, then Save. You are also asked if you want to save your changes whenever you open a new cam, and the program has detected you have made changes to the current file.

To save a Test File, you will be presented with the Save Window as shown on the next page. The program suggests a new cam name which is the same as the current cam name shown at the top of the Main Screen. If you want to save your changes to the same name, simply click on OK. This will update the current cam file with your latest changes.

If you want to save the current set of cam specs with your changes to a new name (and leave the current cam file in the Library unchanged), then click on the suggested file name and modify it as you want. For example, in the window shown on the next page, you may want to add -2 to the current name XDRAG.PTI to create XDRAG.P-2 to indicate this is the 2nd revision of XDRAG.PTI. This is the safest way to make changes, because you can always return to an earlier version and see what you had done.

Certain file names are not acceptable, including:

- Names with more than 3 characters to the right or 8 characters to the left of a period (.).
- Names over 11 characters long (12 characters if one is a period).
- Names which include the characters:

/ \ [] : | < > + = ; , * ? or spaces

- Names with lower case letters. These letters will be converted to upper case once the file is saved.

Figure 3.32 Saving Test File Options

Click on File then Save As to bring up this Save menu.

Click here to save specs to New Test name shown

New name to save test data to. Leave unchanged and click OK to save to the current test name. (This would be the same as clicking on File, then Save.) Click on name in the box to change it, then click OK to save it to the new name.

Name of current test file you are working with.

Click on the down arrow button to pick a different folder to save this test to. Note that the top choice in this list is "Add New Folder". Pick this option and then you can type in a new folder name, This new folder name will be added to the list so that you can save the test file to that folder if you wish. The word "folder" can be changed to most any word in the Preferences menu.

Type in a New Folder Name here if you select "Add New Folder" as the Folder Name.

Click here to bring up standard Windows File Save screen, to let you save a file in most any folder (directory) and disk drive, and to most any file name. Note that files saved this way are not found in the standard Test Library. See Figure 3.32 B

Point	Dev
1	85.
2	80.
3	75.
4	70.
5	65.
6	60.
7	55.
8	50.
9	45.

Test files are saved to folders (directories) you have created in the CAMDATA folder (directory) in the CA20 folder (directory) under PERFTRNS.PTI folder (directory). You *can* copy Windows Cam Analyzer files from programs on other computers to this folder (directory) and they will be found by the program. The Windows Version 2.0 *will* read files produced with the older DOS v1.1. Just copy them into a folder under the CAMDATA folder (other than the Examples folder) using Windows Explorer.

Advance Open or Save Screen

If you click on the Advanced button in either the Open or Save As screen, you will obtain the screen shown in Figure 3.32 B. From here you can access most and file on the computer on most any disk drive.

Figure 3.32 B Advanced Open or Save Screen

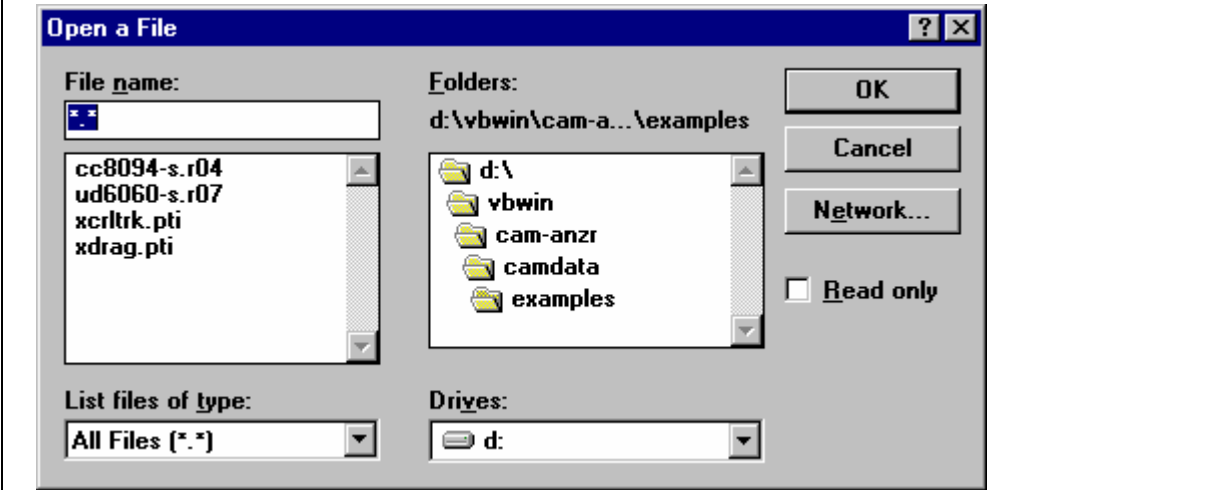

3.6 Opening Other Cam File Formats

The Cam Analyzer can read several different cam file formats, including:

- Cam Dr File
- Cam Pro File
- Comp Cam's File
- Dr Doctor
- S96 File
- Andrews File

You basically try to open one of these files the way you open any other Cam Analyzer file. If it is not a Cam Analyzer file, the program checks if it is one of these other formats. If so, it tells you in the test summary as shown in Figure 3.33.

If you copy this other cam file into a folder in the CAMDATA folder (anything other than the EXAMPLES folder), you can open it by clicking on File, then Open (from all saved tests) at the Main Screen. You will obtain the menu shown in Figure 3.33. If this other cam file is not in a folder in the CAMDATA folder, you must use the Advanced button to search anywhere on the computer (also shown in Figure 3.32 B).

When you actually open this other type of cam file, the program presents the screen of Figure 3.34. Here you enter some basic information the program needs to convert this file into a standard Cam Analyzer file.

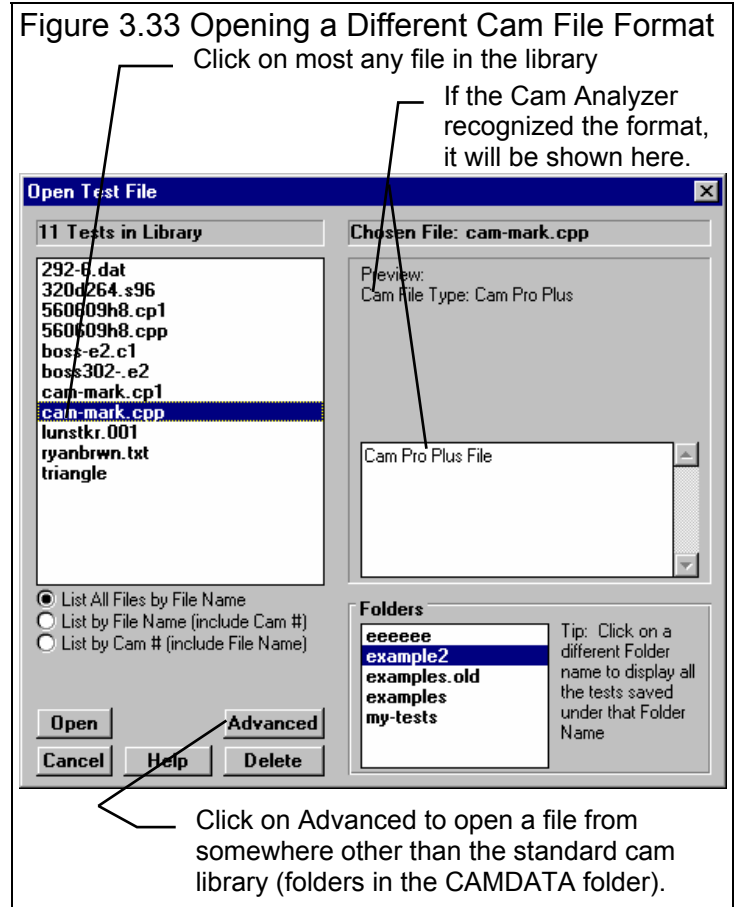

IMPORTANT: The Cam Analyzer does NOT work with or modify the original file it reads. Instead, it creates a new Cam Analyzer file based on the data in this other type of cam file.

Figure 3.34 Setting Specs for an Other Cam File Format

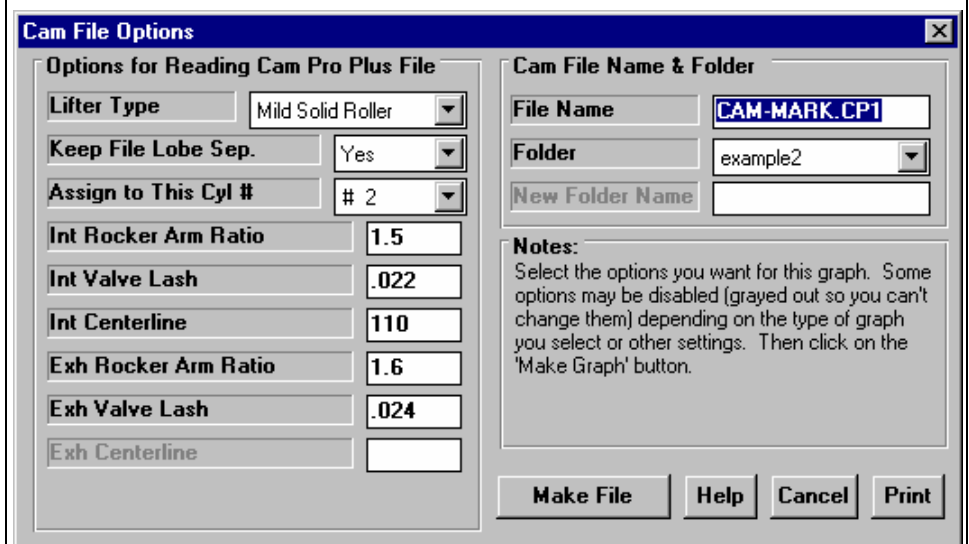

Lifter Type

Click on this combo box to select a description for this cam profile. Depending on whether you select a hydraulic or solid profile, you may or may not be able to enter valve lash.

For Which Type Lobe

If the file contains only 1 cam lobe (intake or exhaust) like an S96 file, pick which type of lobe you want this file stored as.

Keep File Lobe Separation

If the file contains 2 lobes (both intake and exhaust) like a Cam Dr file, select if you want to keep the lobe separation between the 2 lobes that was measured. If you select Yes, then Exhaust Centerline is disabled, because the Intake Centerline and measured lobe separation will dictate where the Exhaust Centerline lies. If you select No, then Exhaust Centerline is enabled so you can enter it.

Assign to This Cyl

Pick the cylinder # you want assigned to this lobe. This is mostly for record keeping for your own information.

Int Rocker Arm Ratio

Int Valve Lash

Int Centerline

Exh Rocker Arm Ratio

Exh Valve Lash

Exh Centerline

Total Cam Advance

These entries are provided so they can be used in the Test Setup specs for the Cam Analyzer file which will be created.

Cam File Name & Folder

File Name

Is the file name of the new Cam Analyzer file which will be created. As with other file names in the Cam Analyzer, certain file names are not acceptable, including:

- Names with more than 3 characters to the right or 8 characters to the left of a period (.).
- Names over 11 characters long (12 characters if one is a period).
- Names which include the characters:

/ \ [] : | < > + = ; , * ? or spaces

- Names with lower case letters. These letters will be converted to upper case once the file is saved.

Folder

Select the folder where the new Cam Analyzer file will be saved. This list will consist of existing folders in the CAMDATA folder (the standard Cam Analyzer library), plus the Add New option. Pick this option and you can enter a New Folder name for storing the new file.

Note: The file must be saved into a folder in the Cam Analyzer library (folders in the CAMDATA folder). If you need it to go somewhere else, you must move it using Windows Explorer or the Save As, then Advanced commands in the Cam Analyzer. You can also use the Save to Floppy Disk mentioned in section 2.1.

New Folder Name

Only becomes activated if you have selected the Add New option for Folder above.

Check Appendix 5 and 6 for features letting your export data files in different formats. Also check Appendix 6 for new features for combining lobes from 2 different cam files.

3.7 History Log

Click on File, then Open from History Log at the Main Screen to obtain the History Log shown below in Figure 3.35. This screen shows a summary of the results for the last 25-100 cams you have worked with (started new, opened, graphed, etc.) The number of cams in the log (25-100) is selectable in the 'Preferences' menu at the Main Screen. When you work with a new cam, it is added to the top of the History Log, and (if the Log is full) the last run drops off the bottom of the list. The History Log is an alternate way to Open cams which have been saved to the Test Library. The advantage of the History Log is it lists the cams you most recently worked with at the top.

Figure 3.35 History Log and Options

Click on File, then Open from History Log

Click on Test Title to Open that Test File.

Click in the Save column to enter a Yes or erase a Yes. All tests move to the bottom of the History Log and eventually fall off the list as you work with new tests. However, Tests marked Yes do not fall off the list.

Click and move slide bar down to display all 25-100 tests in the History Log.

Click and move slide bar right to display more columns of test results.

Test File and Path	Save?	Cam #	Int Lift	Dur	Test Date	Exh Lift	Dur	File Type
\examples\wdrag.pti		CompCam00457	.470"	279.7	02/07/1994	.423"	293.1	Measured
\examples\wctrlrk.pti	Yes	Reed00022	.436"	258.4	03/05/1994	.434"	259.7	Measured
\examples.new\wdrag.pti	Yes	CompCam00457	.470"	279.7	02/07/1994	.423"	293.1	Measured
\examples.new\wctrlrk.pti		Reed00022	.436"	258.4	03/05/1994	.434"	259.7	Measured
\examples.new\ud6060-s.r07		UltraDyne00344	.436"	258.4	03/05/1994	.434"	259.7	Measured
\examples.new\cc8094-s.r04		CompCam00457	.470"	279.7	03/13/2000	.423"	293.1	Measured
\examples\cc8094-s.r04			.470"	279.7	04/06/1994	.470"	293.1	Measured
\my-tests\cam-mark.cp3			"		03/06/2000	0"		
\examples\boss302-e2			"		06/13/1994	5"		

Click on Test Title (1st Column) to Open that test. Click and slide button right for more History info. (Dur. meas. at .050".)

From this screen you can Open a cam file by clicking on the 'Test File and Path' column (first column on the left). If the cam file was saved to a standard folder (directory, or whatever you have chosen to call folders in the Preferences menu), the folder name is given first, followed by the cam file name.

If a cam file has been Opened from or Saved to a non-standard folder (a folder *not* in the CAMDATA folder) using the 'Advanced' function, the entire path is given. If the 'Path and File Name' won't fit, it is shortened and preceded by '...'.

You can choose to Save certain results you believe are special and you may want to recall or graph in the future by clicking on the Save column to insert a Yes there. Tests marked Yes to Save eventually move to the bottom of the History Log, but are never dropped off the list or erased until you again click on the Yes to make it blank.

Note that just the Test File Name stays in the History Log. Should you delete the file using the Open (from all saved cams) command, the cam file will be deleted. When you try to open it or graph if from the History Log, you will get note saying the file can not be found.

You can print the History Log on a printer by clicking on the 'Print' menu command. Note that the History Log will be most readable when the Page Orientation is in Landscape setting.

The Max Lifts and Durations at .050" listed in the History Log are handy to remind you what a cam was, and for comparing different cams.

History Log at Graph Screen

At the Graph Screen, several options are available to graph selected cams from the History Log, and change the Graph Titles. You can obtain the History Log by clicking on the menu command History Log at the top of the Graph Screen. The History Log is how you graph different cams together for comparison. From this screen you can:

- Choose to Graph certain Test Results by clicking on the Graph column to insert a Yes there. Tests marked Yes to Graph will be graphed when you click on the 'Graph Tests Marked 'Yes' '. The first cam (usually the current Cam Test you are working with) is always graphed even with no Yes marked. The number of cams actually graphed are limited by available space, usually a limit of about 24 graph lines total.
- Graph only the current cam results (the cam file at the top of the Log) by clicking on 'Graph Current Test Only'.
- Click on 'Graph Title' to change the Standard Title for this cam. The program defaults to putting in the Cam # unless it is blank, when it then puts in the cam file name. (You can also specify 'Alternate' titles and legend names by clicking on 'Format' at the top of the Graph Screen, then 'Edit Titles/Legends'.)
- Choose to Save certain results you believe are special and you may want to recall or graph in the future. See the Save explanation of the previous page.

Figure 3.36 History Log at Graph Screen

Click in the Graph column to add a Yes or remove a Yes. Tests marked Yes will be included in the graph if there is enough room and if you are doing Multiple Test graphs.

These are the standard names for these files if they are graphed. The program defaults to the Cam Number, but you can click in this column and change the name to most anything of 16 characters or less.

Test File and Path	Graph?	Std Graph Title	Save?	Cam #	Int Lift	Dur	Test Date
\examples\xdrag.pti	Yes	compcam00457		CompCam00457	.470"	279.7	02/07/1994
\examples\xcrltrk.pti	Yes	reed00022	Yes	Reed00022	.436"	258.4	03/05/1994
\examples.new\xdrag.pti		compcam00457	Yes	CompCam00457	.470"	279.7	02/07/1994
\examples.new\xcrltrk.pti		reed00022		Reed00022	.436"	258.4	03/05/1994
\examples.new\ud6060-s.r07		ultradyn00344		UltraDyne00344	.436"	258.4	03/05/1994
\examples.new\cc8094-s.r04		compcam00457		CompCam00457	.470"	279.7	03/13/2000
\examples\cc8094-s.r04		cc8094-s.r04			.470"	279.7	04/06/1994
\my-tests\cam-mark.cp3		dskl jsdacam222			"		03/06/2000
\examples\boss302-e2		cam000347			"		06/13/1994

Click in 'Graph?' column to select or de-select tests for graphing. Slide button right for more History info. (Dur. meas. at .050")

3.8 Create Cam Dr File

This command will display the menu shown in Figure 3.37. The Cam Dr (tm) is a popular computerized cam measurement tool. It stores its data on disk so it can be retrieved later for analysis by the Cam Dr's software, or used in other software. Performance Trends' Engine Analyzer' Pro' can read a Cam Dr file to precisely simulate valve train dynamics and engine performance with your exact cam profile. Therefore, if you want to create a cam profile file of the current Cam File shown on the Main Screen, you would use this command.

Check Appendix 5, 6 for several new features for creating new data file formats.

Figure 3.37 Create Cam Dr File Screen

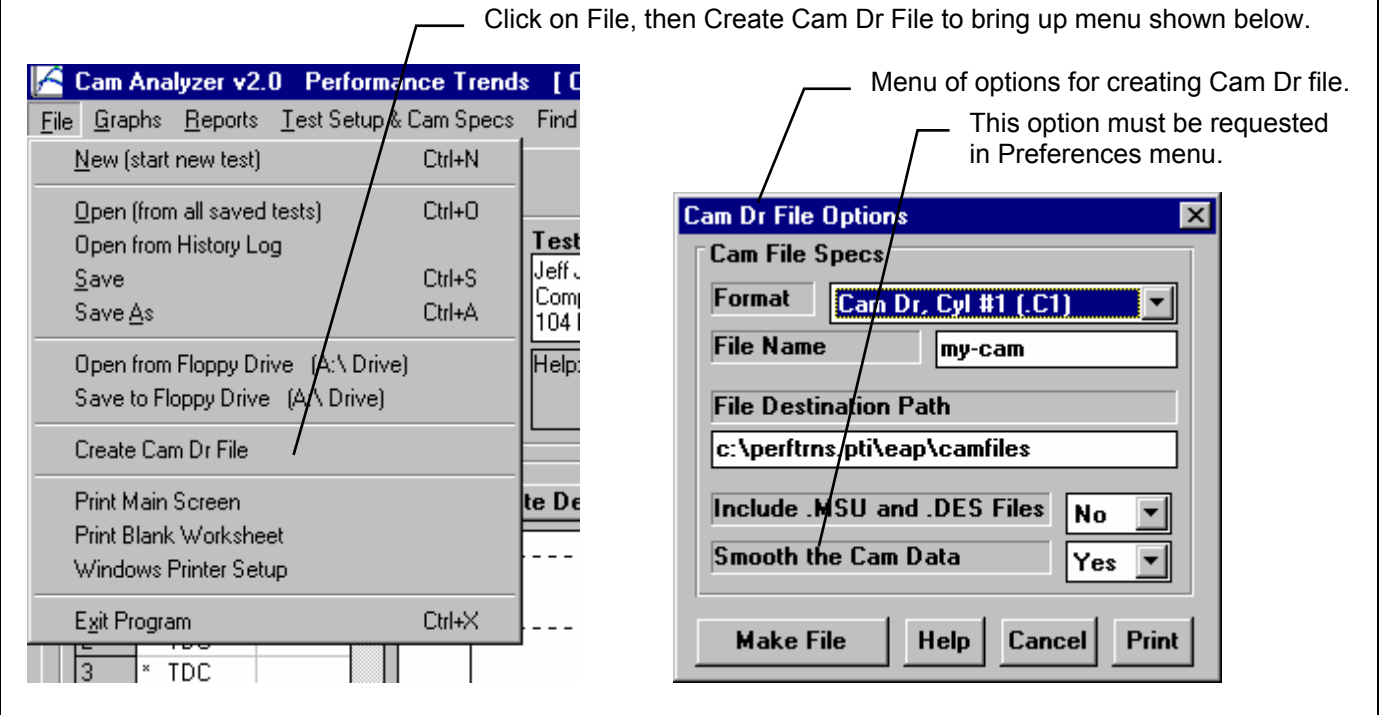

Format

Is the type of Cam File to create. In this version, all formats are Cam Dr formats. Your only choice is the extension, C1 to C16 identifying which cylinder the file represents.

File Name

Is the name you will give to the file. The name can only be up to 8 characters long and not include any spaces or the characters: / \ [] : | < > + = ; , * ?

File Destination Path

The File Destination Path simply tell the Cam Analyzer where to store the Cam Dr file on disk. For example, if you were going to use the file in the Engine Analyzer 'Pro', you would store it in the 'Pro's CAMFILES folder. Figure 3.37 shows the proper destination specs for using the Cam Dr file with the Engine Analyzer 'Pro' if the 'Pro' is stored in its default location (c:\perftns.pti\leap).

Include .MSU and .DES Files

A Cam Dr file created by the Cam Dr software usually consists of 3 computer files. The most important one contains the cam lift profile and has the computer name extension of .CXX. The XX is a number from 1 to 16 which stands for cylinder #. This extension you select with the Format option.

Two additional files are created which include a .MSU file for Measurement Set Up and a .DES file with the cam DEscription. Some programs may not need the .MSU and .DES files, like the Engine Analyzer 'Pro'. Therefore, it is a waste of time and disk space to create and store these files. Therefore, to create files for use in the Engine Analyzer 'Pro', you would set this spec to No.

Smooth the Cam Data

A powerful feature of the Cam Analyzer is the ability of it to mathematically “smooth out” data recorded by hand so that it appears as accurate as data recorded by computerized instruments. This is much more than typical filtering that other computer programs can do. This accuracy is required for detailed work like simulating valve train dynamics in the Engine Analyzer Pro. Therefore, for almost all situations it is recommended you select Yes for this option.

However, sometimes users want the Cam Dr file to be *exactly* the same data as they have entered by hand. In that case, you can select No and no smoothing will be done to the data before the file is written.

Note: You must set the Preferences option of Allow Not Smoothing Cam File to Yes before this option is visible. See Section 2.2, Preferences.

Chapter 4 Examples

Each example in this chapter becomes progressively more complex, assuming you have performed and understand the preceding example. Section 1.5's example is somewhat more basic than Example 4.1, so it may be a better place to start if Example 4.1 looks complicated.

The results shown in these examples may be somewhat different than what you obtain with your particular version of the program. That is due to minor upgrades in the calculations in later versions.

Example 4.1 Running A Cam Test By Entering Cam Lift Measurements Directly Into The Computer, With TDC Procedure

This example demonstrates the basic steps for running a cam measurement test. Specifically the test is of a solid roller cam for drag racing with approximately 280 intake/294 exhaust duration and 104 degrees lobe separation. The file being created is actually the XDRAG.PTI Cam Test file in the Examples folder, but we will call it CC8094-SR04.

The Cam Analyzer program works best if the computer can be next to the engine as the test is being performed. This allows the computer to easily assist in setting the engine to TDC, and immediate checking (and possibly correcting) of Cam Lift entries with graphs.

The Cam Analyzer has several options for filling in cam data on the Test Data grid. The particular steps given below are not the only way to run this cam.

In Windows 95 or 98, start the program by clicking on Start, then Programs, then Perf Trends, then Cam Analyzer v2.0. When you enter the Cam Analyzer, you may see the question in Figure 4.1. If you answer No, you will start with a blank screen. If you answer Yes, the program will put you back to precisely where you were when you last quit the program. Even though you are starting a New Test, click on Yes to bring up the last cam you were working with.

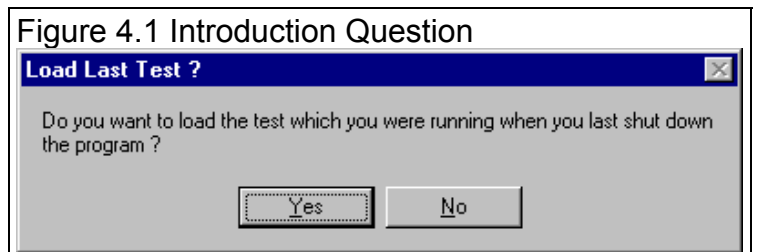

Click on File (upper left corner), then New Test to bring up the New Test screen, which will likely show a Tip message. See Figure 4.2. As the Tip in Figure 4.2 says, it is easier to start with a Cam Test file that is close to the cam to be measured. This prevents us from having to make major changes to cam information like the Test Setup and Cam Specs, etc. However, since you have not measured a cam like this one, you can start this cam with whatever the Current Test is.

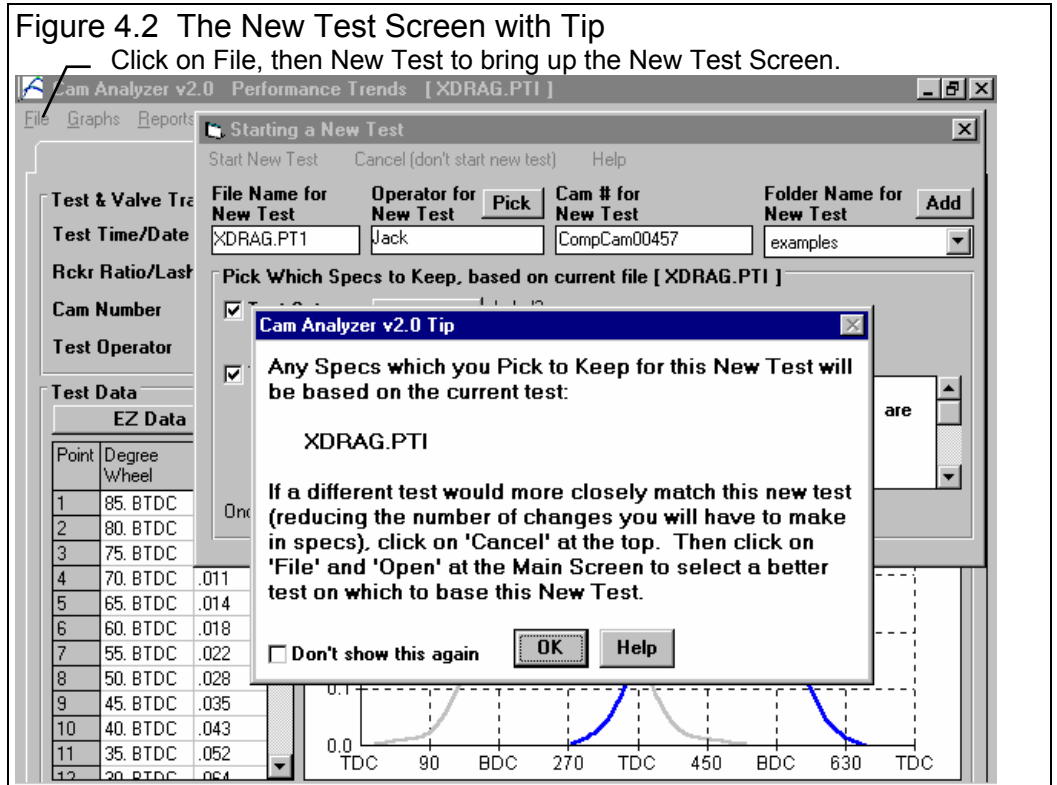

The New Test screen appears as in Figure 4.3. There are 4 critical specs at the top which must be filled out or picked.

Filling Out Specs to Start a New Test

If you want to check or modify some specs from the previous cam, click on the 'See Specs' buttons for Test Setup. Click on Help at this menu for more info on how to enter these specs.

Figure 4.3 4 Critical specs for the new test are listed here at the top. Click here to start a New Test based on these settings.

A summary of the current Test Setup settings is given here.

Click on this button to see the current Test Setup settings.

You can edit the current comments here for the new test.

Click here to Check or Uncheck options. Checking means you want to keep these comments for the new test. Once the new test is started you can then make modifications to these specs if you want. (Test Setup must remain checked.)

Two critical specs in the Test Setup include the Degree Wheel Type and # Deg (number of degrees between readings). The summary shows that these settings are for “Degree Wheel Type: TDC - 90 - BDC - 90 - TDC in 5 degree steps for a solid lifter (follower) cam” are correct for the test you will be running, so you don’t have to change them. You also change the test comments to something more meaningful for this new test, about the cam being for Jeff Johnson’s BB Chevy.

Most specs *can* be changed once the cam has started with little problem. However, there are four other critical specs listed separately at the top. These *must* be filled out before you can start the new cam:

1. File Name for New Test is the file name the program will create for saving the Cam Data for the new cam you are starting. The program fills in a default name of the current cam name, but incrementing the last digit in the name by 1. You can change this name to most anything you like. The program will warn you if the name entered is not valid and show you what is wrong. **For this example, type in the name: CC8094-SR04** for this cam. This could stand for a Competition Cam's cam with specs of 280 intake and 294 exhaust duration @ .050". The "SR4" could stand for a Solid Roller with a 104 degree lobe separation. Develop a method of naming cam files which fits your needs.
2. Operator for New Test is the name of the operator for this cam. Click on Pick to pick an operator name already used or to enter a new name. The program defaults to the operator of the current cam. **Through the Operator Menu discussed in Section 2.1, you enter a new Operator name of Jack.**

Figure 4.4 New Test Menu for Starting This New Test

Click Here to Start the New Test

3. Cam # for New Test is critical for shops who use a cam numbering system. Click on Assign to create a new Cam # based on the last Cam # assigned (incremented up by 1) or to start with a new type of Cam #. **Through the Cam # Menu discussed in Section 2.1, you enter a new Cam # of CCSR0047.** If you do not want to be forced into a certain format for entering cam numbers, or want to be able to leave the Cam Number entry blank, choose that Preference in the Preferences menu described in Section 2.2.

4. Folder Name for New Test is the folder in the CAMDATA folder where the cam will be saved. The program may not be using the name 'folder' for this spec, but whatever word you have assigned in the Preferences menu at the Main Screen. The folder name 'Examples' is reserved for Performance Trends example cams supplied with the program, and can *not* be used for your cams. **By clicking on Add New, you add the new folder of BB-CHEV for this cam.**

The New Test screen should now look like Figure 4.4.

When you are ready to start the New Test, click on 'Start New Test' at the top of the screen. If some critical specs have not been entered, the program will warn you and ask you for it at that time. The program will fill in the Test Time and Date based on the computer's time and date. This can be changed later by clicking on the Test Time/Date at the Main Screen.

Figure 4.5 Main Screen after Starting New Test

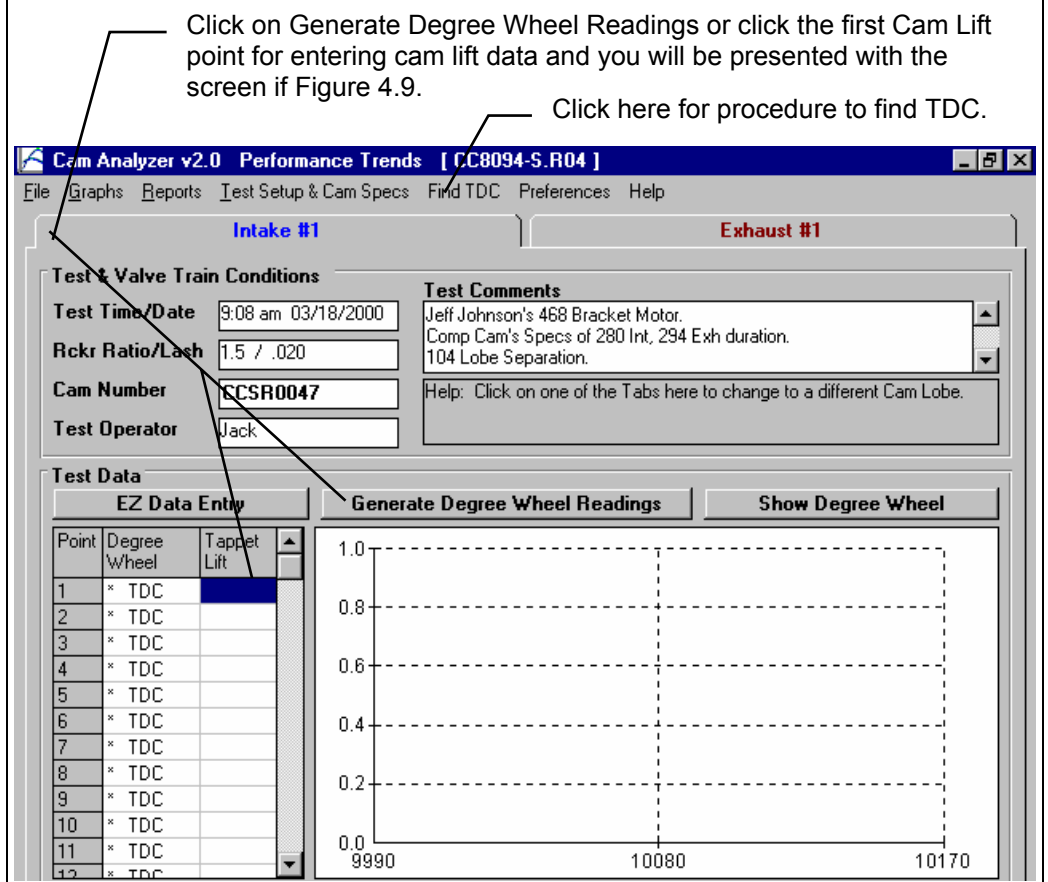
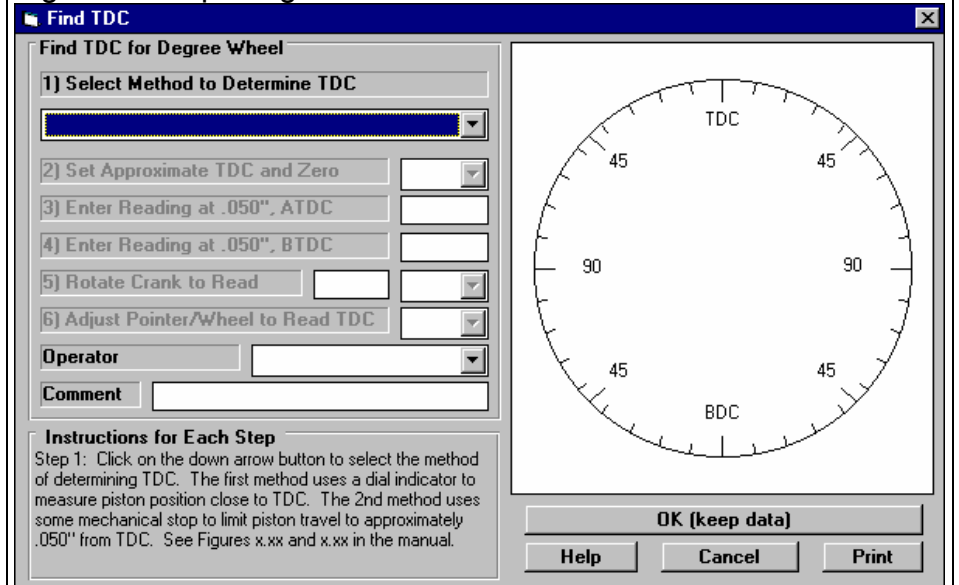

Figure 4.5 shows the Main Screen you get from starting a New Test. There are no Degree Wheel readings generated and the Cam Lift column is blank.

Procedure to Find TDC

If you simply want cam profile data (duration, overlap, lobe area, etc.) or to create a Cam Dr file for use in other software, an accurate TDC is not critical. Then you can skip the procedure to set TDC. TDC is critical if you want to know how this particular cam is timed in this engine. Then all

Figure 4.6 Opening Screen to Find TDC



Cam Analyzer calculations including lobe centerline, opening and closing events at .050" lift, etc. will be accurate. For background on how the Finding TDC procedure works, see Section 2.4.

Click on the Find TDC command at the top of the Main Screen, shown in Figure 4.5 to obtain the screen shown in Figure 4.6.

You must first "Select the Method to Determine TDC", the method you will use to determine piston position on either side of TDC, either:

Method 1 uses a dial indicator to measure out 2 points on either side of TDC. A disadvantage of Method 1 is that the heads must be removed (or you need a special dial

indicator which can access the piston dome through the spark plug hole.)

Method 2 uses a mechanical stop in the cylinder or head. A stop can be a stiff bar bolted to the engine deck as shown in Figure 2.17 on page 29. Or it can be a spark plug body with the porcelain removed and a bolt welded in its place. This type can be used with the head installed, but can bend (introducing errors), damage a piston with a complicated dome, or not work at all depending on spark plug installation angle. The stop will contact the piston at the same distance from TDC with the crank on either side of TDC. Two disadvantages of Method 2 include:

- Possible damage to the piston if too much force is used to seat the piston against the stop.
- Depending on the design of stop, you may have to remove and adjust or file the stop if the degree wheel readings do not fall into the range allowed by the Cam Analyzer.

1) For this example, we will use Method 1, so select the Dial Indicator method. You will notice that as each step is answered, the next step becomes enabled so you can answer it.

2) Set Approximate TDC and Zero. This step is to get the degree wheel in the "ball park" so you can take some readings to find *exact* TDC. Position #1's piston to the highest point in the bore (approximately TDC). Install your degree wheel on the crank and pointer to read approximately TDC. Install your dial indicator and set it to read approximately .000". Choose 'Done' when done.

3) Enter Reading at .050", ATDC. Rotate the crank CLOCKWISE until the dial indicator reads exactly .050". Enter the degree wheel reading at this point. Note that the direction of rotation and the number you enter are displayed on the degree wheel drawing. The pointer reads 22 deg after TDC on the wheel, so enter 22.

4) Enter Reading at .050", BTDC. Rotate the crank COUNTER-CLOCKWISE until the dial indicator again reads exactly .050" on the other side of TDC. The pointer reads 17 deg before TDC on the wheel, so enter 17.

5) Rotate Crank to Read **2.5 ATDC**. Now the program has enough data to "split the difference" in the 2 readings you have entered. When you rotate the crank to the reading calculated by the program (2.5 degrees After TDC), the piston will be exactly at TDC. **WITHOUT LOOSENING** the degree wheel or adjusting the pointer, rotate the crank CLOCKWISE until the pointer reads the number as shown in Step 5 above. Cyl #1's piston is now exactly at TDC. Choose 'Done' when done. See Figure 4.8.

6) Adjust Pointer/Wheel to Read TDC. Now you can adjust the pointer or degree wheel to read TDC so they exactly match the piston's TDC position. **WITHOUT MOVING CRANK OR PISTON**, adjust the pointer (or loosen and rotate the degree wheel) until the pointer and wheel read exactly TDC. Choose 'Done' when done.

Figure 4.7 Hardware Required and Installation for Method 1, Dial Indicator Method

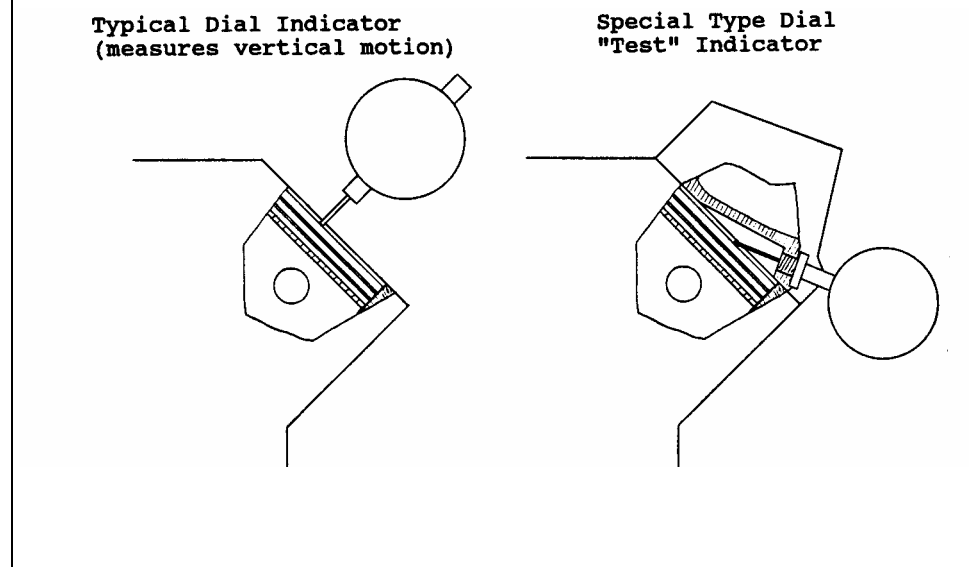

Now you have the degree wheel reading TDC when the piston is positioned at TDC. If you want, you can now enter an operator name, like Jack, and any comment about the TDC procedure. You can now also print this data for a permanent record.

Click on the OK (keep data) button and this data is also stored with the Cam Analyzer file so you can review it or print it in the future. You will be returned to the Main Screen. Nothing in the program has changed, except now the degree wheel accurately reads crank position.

Figure 4.8 Program Calculates Reading for Exact TDC

After entering 2nd reading, program calculates where pointer should be to place piston at exact TDC.

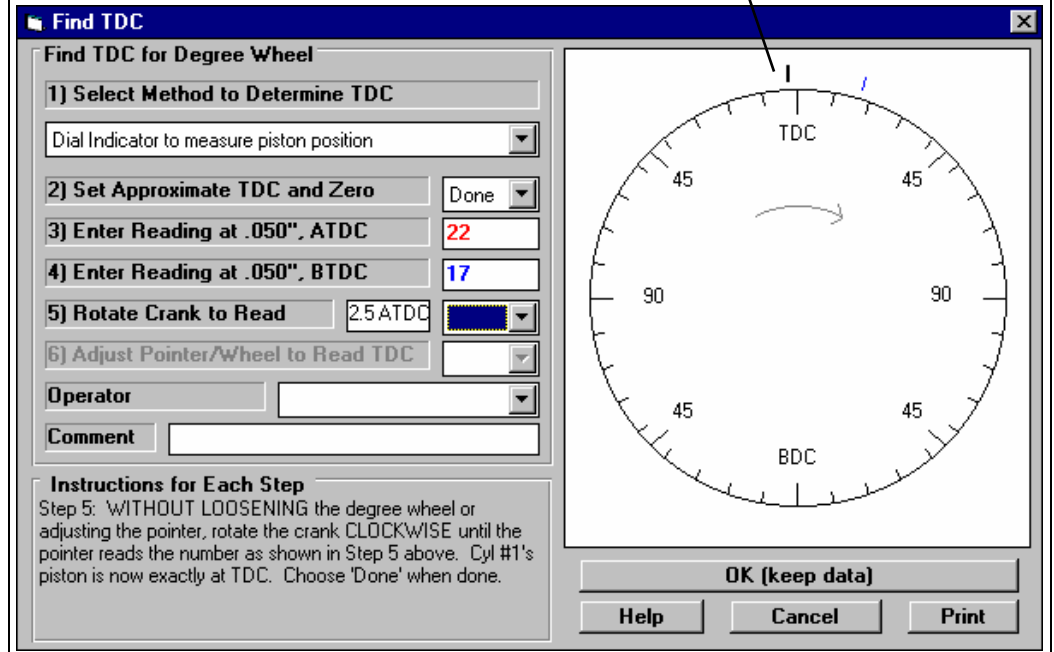

Generating Degree Wheel Readings

As shown in Figure 4.5, you can click on the Generate Degree Wheel button to fill in all the degree wheel readings automatically to obtain the menu shown in Figure 4.9. You have already specified that you will take readings every 5 degrees in the Test Setup specs. However, the program needs to know where you will take your first reading.

At this time, mount your dial indicator base to the engine deck and set your dial probe on the intake tappet of Cylinder #1. You should have the rocker arm and pushrod removed so little pressure is placed on the lifter causing deflection or hydraulic lifter "bleed down".

You may want to insert a small flat washer into the lifter body to create a flat surface for the dial indicator probe. The dial indicator must be exactly in line with the lifter bore for accurate Cam Lift measurements. You may also need an extension for the dial indicator probe. Some cam grinders sell tools to make this job easier and more accurate.

Note: If you measure Cam Lift from the pushrod, be sure the dial indicator probe sets into the pushrod's oil hole and the guide plate holds the pushrod close to its "installed" location and angle. Measuring cam lift from the top of the pushrod side of the rocker arm can be difficult and may create errors. See Appendix 1 for tips on accurate measurements.

Figure 4.9 Blank Screen for Generating Degree Wheel Readings

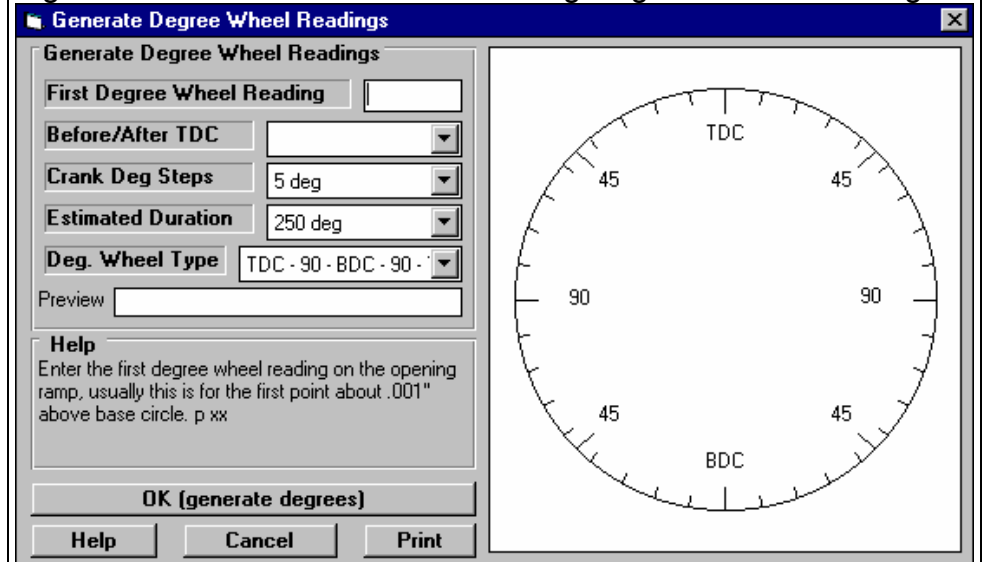

Rotate the crank until you are on the opposite side of the cam from the "nose". This ensures you are on base circle. At this time, set your dial indicator to .000".

Now start rotating the crank in the direction of normal rotation (clockwise when viewed from the front for most standard rotation engines). You should see very little change on your dial indicator until you get to the opening ramp. This ramp will not start until around 70 degrees BTDC on the intake. For mild cams it may not start until 30 degrees BTDC, for radical cams it may start at 70 degrees ABDC. (These values would change for other Degree Wheel Types and for the exhaust lobe.)

When you have seen approximately .002" Cam Lift from base circle, assume you are starting the opening ramp. Find a point with approximately .002" lift at an even Degree Wheel reading like 70 or 75. This will create regular readings generated at 5 degree increments.

For this example, .002" lift occurs at 85 degrees BTDC, so we enter 85 for First Degree Wheel Reading and choose BTDC in Generate Degree Wheel Readings shown in Figure 4.9. Since this a long duration, race cam, we estimate the duration from about .002" to .002" to be 450 degrees. (Note that this is much greater than the duration rated at .050" lift.) If the actual cam is more or less than this, we can easily change it once measuring starts.

Click on OK (generate degrees) and you are returned to the Main Screen with the Degree Wheel readings column filled in, and starting at 85 degrees ATDC. See Figure 4.10. Now you can start recording actual cam lift data.

Recording Data

Enter the .002" tappet Cam Lift for the 85 BTDC point. Then turn the crank to the next Degree Wheel Readings point of 80 BTDC where the dial indicator now reads .005. Enter .005 in the Cam Lift column for 80 BTDC. Continue turning the crank to each new Degree Wheel Readings point and enter the Cam Lift reading from the dial indicator.

Note: Generally, gravity and the dial indicator spring are enough force to keep the lifter in contact with the cam lobe. However, you may want to press lightly on the lifter (not disturbing the dial indicator) to keep it in contact with the cam lobe before recording each Cam Lift measurement.

As you progress, each point is graphed on the Summary Graph to "flag out" errors in the data.

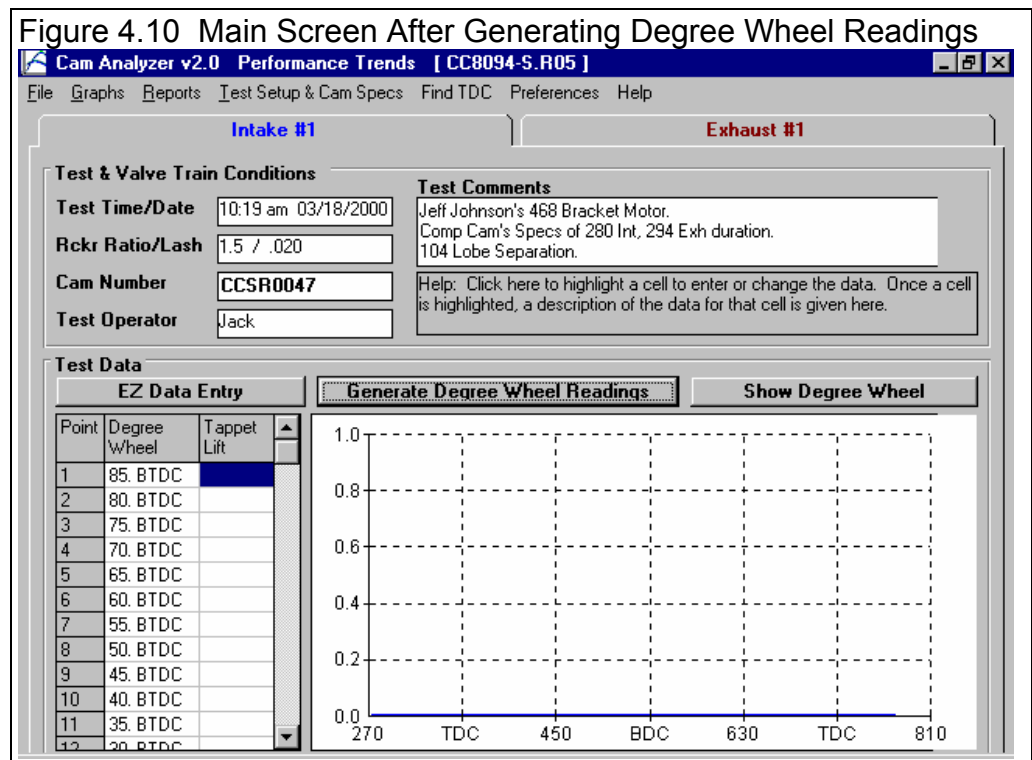

Using EZ Data Entry

After you have entered at least 2 Cam Lifts, you can click on the EZ Data Entry button to open the EZ Data Entry. This screen can save you considerable time and help you avoid making errors entering data. See Figure 4.11. By using the keyboard keys of Insert, down arrow, left arrow and right arrow, the program can estimate the next Cam Lift, and you can fine tune this estimate to within .0005".

For example, in Figure 4.11, you have entered .002 at 85 BTDC and .005 at 80 BTDC. A reasonable estimate of the next Cam Lift at 75 BTDC would be .008. If you click on the Estimate Next Lift button (or just press the Insert key), the program will fill in .008" for 75 BTDC. If the actual dial indicator reading was .009, you could just click on the Nudge Up button (or tap the right arrow key) twice to bump up the estimated lift of .008 to .009. Each "Nudge" is .0005". See Section 2.7 for more details.

Figure 4.13 Graph Menu to Check Intake Lobe

Figure 4.11 EZ Data Entry Screen

Click here to bring up the EZ Data Entry Screen.

Choose Intake Cam Data for the Type

Choose Lift, Velocity and Acceleration for the data to graph

Choose Scale Factors so Velocity and Acceleration show up well on the graph.

Choose Scale Factors so Velocity and Acceleration show up well on the graph.

Since we are recording data by hand, set Lift Filtering to Some. Keep other filtering to a minimum because you are looking for possible problems.

Continue recording data at every 5 degree interval stated in the Degree Wheel Column or in the EZ Data Entry screen until the lifter returns to approximately .002" Cam Lift or less. Now you are at the end of the cam profile. The Cam Lift of .002 actually occurs at 67 BTDC, but you go to 65 BTDC where you record .001" Cam Lift for the last Cam Lift point.

At this time you may want to delete the extra Degree Wheel points in the Degree Wheel column. This can be done by clicking on Point 78 in the Point column to bring up the Edit menu, shown in Figure 4.12.

If you ever want to add rows past 78 in the future you can simply click on the Cam Lift column for row 78 (there won't be a number 78, just a blank) and start typing in a lift. If the last lifts are greater than .015", you can also click on Generate Degree Wheel Readings and increase the duration beyond the current duration.

Figure 4.12 Edit Command to Delete Rows

Click here do delete this row and all remaining rows. This brings up Edit menu shown below.

Click here to actually delete rows.

If you had clicked on Point #1 (the first row), an Insert button would appear here so you could add rows at the beginning of the cam profile.

Point	Degree Wheel	Tappet Lift
69	75. ABDC	.030
70	80. ABDC	.024
71	85. ABDC	.019
72	90. BTDC	.015
73	85. BTDC	.012
74	80. BTDC	.008
75	75. BTDC	.005
76	70. BTDC	.003
77	65. BTDC	.001
78	60. BTDC	
79	55. BTDC	
80	50. BTDC	

To add rows at the beginning of the profile, click on Point 1 in the Point column, and an Insert button is added to the Edit menu shown in Figure 4.12.

Check your Measurements

With the intake lobe completed and *before* you remove the dial indicator, let's check what the Cam Analyzer says about these measurements.

A good way to check out the Intake Lobe data is to graph the data. Click on Graph at the top of the Main Screen and the Graph Options menu appears. A good Type of graph to check the Intake lobe would be Intake Cam Data. See Figure 4.13.

Any time a graph or report is made of data you have entered by hand, the program performs "mathematical smoothing". During this process, the program can check for cam lifts which seem "out of line" with other the other cam lifts.

If "bumps" or points which look "out of line" are found in the data file, a message could be given as shown in Figure 4.14. In this case, cam lift was recorded in error as .138" when it should have been .128", an error of .010". (Also see how this .010" error would look in a velocity and acceleration graph shown in Figure 4.16.) The Cam Analyzer can be quite helpful at screening your data measurements.

Having points which are "not smooth" do not necessarily mean errors were made recording Cam Lift data. These points could mean:

- They could simply be changing direction faster (have higher acceleration rates) than what the Cam Analyzer's smoothing or filtering scheme expects. This is especially possible if you are using Deg Steps of 10 or more rather than the recommended 2, 4 or 5 degrees.
- They could be pointing out an actual "bump" in the cam profile. This bump may be "smoothed" over and not noticeable in the graphs. See Figure 3.17 on page 54.

The actual data point which is "not smooth" may be next to a point which is listed in the "not smooth" screen. For example, Points 15, 16, 17 and 19 are all pointed as "not smooth", but actually Point 16 is the only one with a problem.

In any event, these points are ones which you should double check before you move the dial indicator and go to the Exhaust Lobe. For this example, no points were found to be "not smooth". The Cam Analyzer will produce a graph like Figure 4.15.

The general shape of these lift, velocity and acceleration curves are the same for most cam profiles, both intake and exhaust lobes. For this first graph, look for any "bumps" in the lift, velocity and acceleration curves. Bumps are an indication of a potential problem with the cam, the grinding of the cam, or quite likely an error entering data. Bumps in the lift curve produce larger bumps in the velocity curve which result in even larger bumps in the acceleration curve. Therefore, the acceleration curve will be the most bumpy and most likely to show up problems. Even though there are some bumps in this acceleration curve, they are normal.

Figure 4.14 Message Identifying Possible Bad Data

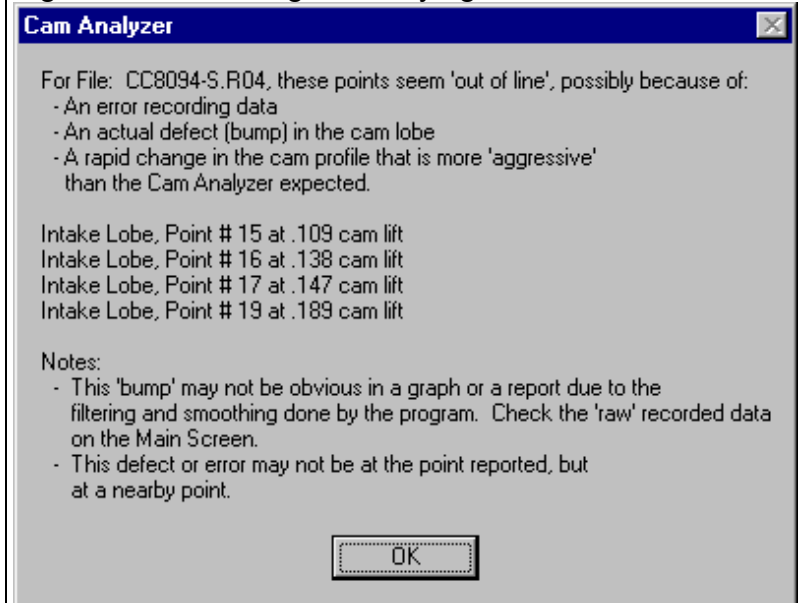

Since the cam graphs in Figure 4.15 look good, we can do one more quick check. Click on Back to return to the Main Screen. When there, click on Report at the top of the screen to open up the Report Options menu, Figure 4.17. Select the Intake Duration report as the Type, then click on the Make Report button.

You may get a message saying "ONLY 0 DEGREES ON EXHAUST LOBE." This makes sense since you have not yet measured the exhaust lobe yet. When the report is presented, there is a summary at the top showing duration and events at .050" lift, centerlines, etc.

Eventually, you will get the report of Figure 4.18. From this report you can check the duration of the intake profile at any particular cam lift. In addition, all reports give a Summary at the top, which gives events at .050", centerlines, etc. By comparing these measured events to the cam grinder's specs, you can see if you should double check your measurements.

For example, if the measured specs are within 2 degrees of the cam grinder's specs, your measurements are probably good. If they do not agree within 2 degrees, you may want to recheck your Cam Lift data, depending on how critical this cam is.

If the CLine (centerline), LbSep (lobe separation) or Lift in the Report Summary are out of spec, check your Cam Lift readings in the area around maximum Cam Lift. If the other readings are out of spec, check in the area around .050" lift on both the opening and closing ramps. If duration is within specs, but the Open, Close or CLine (centerline) are not, you may want to recheck:

- TDC.
- To see if the pointer has moved or degree wheel has slipped.
- That you installed the cam correctly per the timing marks.
- That your timing gears or chain do not have too much wear.

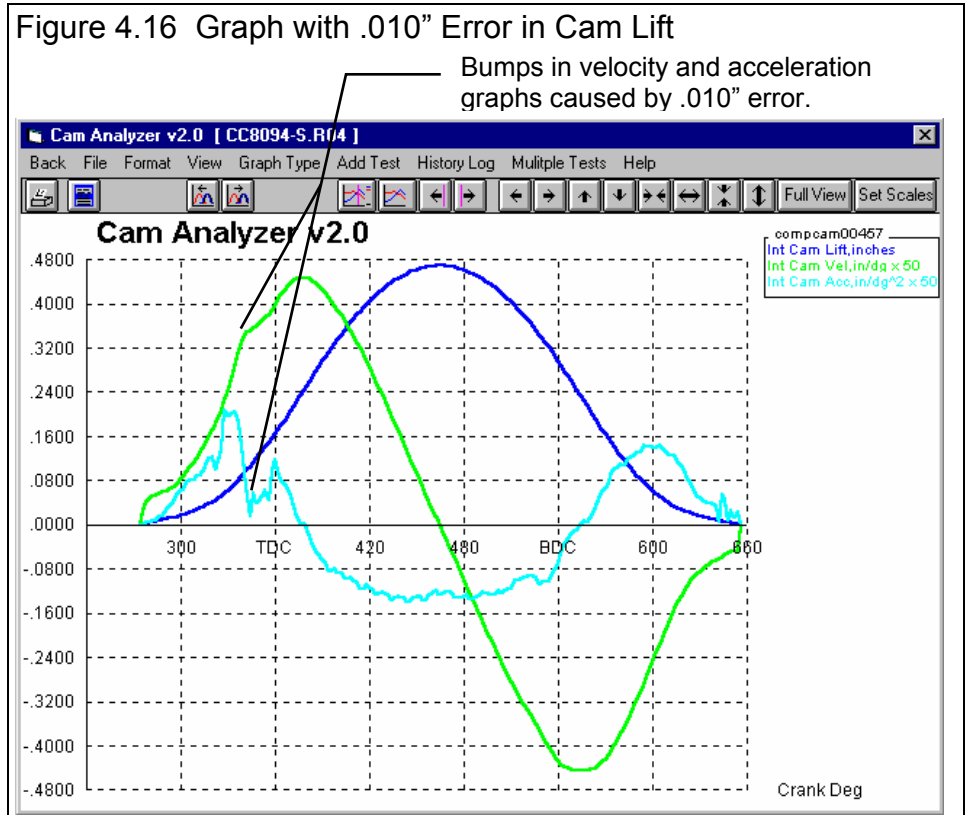
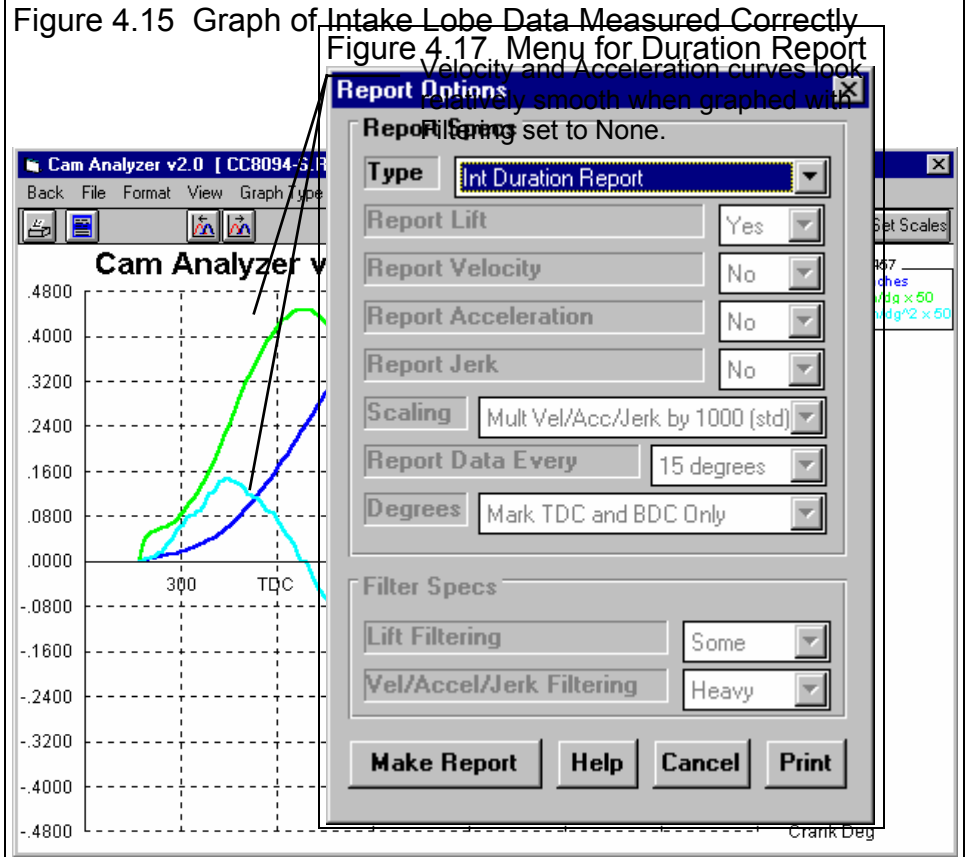

Note: If we were doing measurements every 10 degrees, instead of every 5 degrees, our measurements would not be as accurate. Then we could only expect to be within, say 3-4 degrees of the cam grinder's specs. See Appendix 1.

Table 4.1 compares the cam grinder's duration specs with those actually measured. Since all Intake specs are within a couple degrees of our measurements, we can assume that our measurements are good. (It also compares Exhaust specs and measurements, however they have not yet been measured in this example.)

Note: Do not be surprised if cams are not ground exactly to the advertised specifications. Production tolerances make it nearly impossible for cams to be ground exactly to spec at an affordable price. Fortunately, minor changes in cam duration and timing have a relatively small impact on engine performance. However, small "bumps" on cam profiles can produce abnormally high wear on valve train components.

Save Measure Data

Since all our checks of the Intake Lobe look good, we can assume we have not made any major errors measuring the Intake Lobe. Click on Back in the Report Screen of Figure 4.18 to return to the Main Screen. At this time it is a good idea to save the data you have measured up to this point. Click on File, then Save at the Main Screen to save the current data to the current Cam File Name of CC8094-SR04. If you had wanted to save the Cam File to a different name, or to a different folder, you would have clicked on Save As.

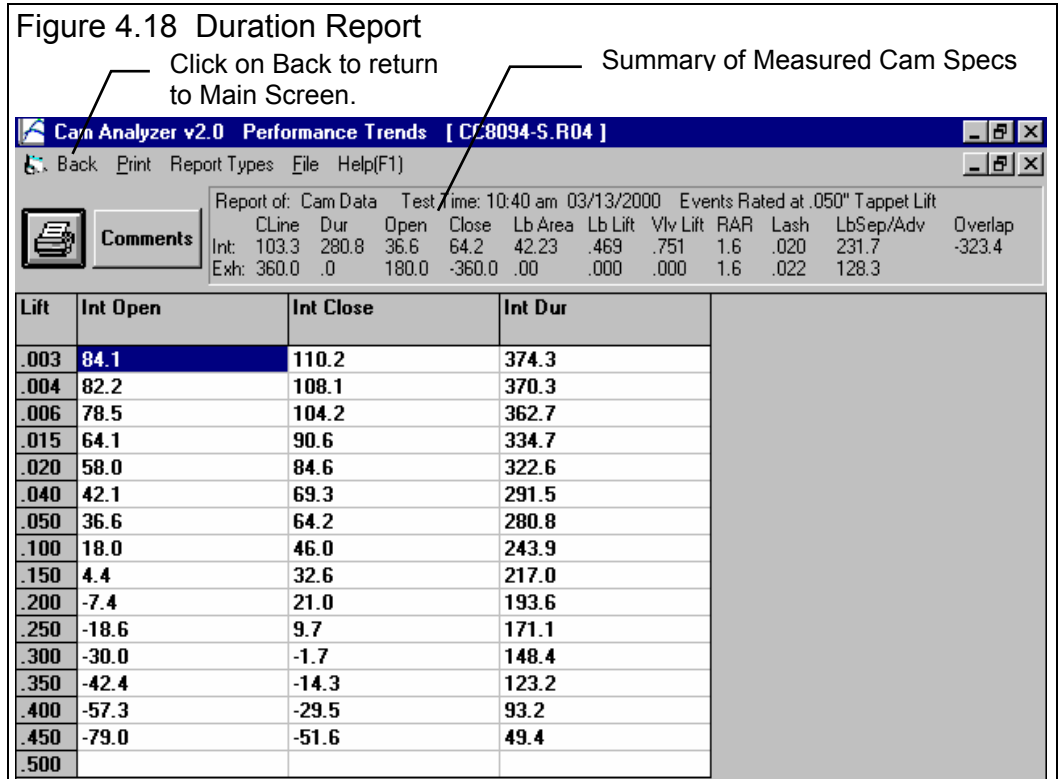

Table 4.1 Measured Cam Data versus Cam Grinder's Specs

Spec	Cam Analyzer	Grinder's Specs
Lobe Lift	Int .469	Int .470
Lobe Lift	Exh .423	Exh .420
Duration @ .050	Int 280.8	Int 280
Duration @ .050	Exh 293.8	Exh 294
Duration @ .200	Int 193.8	Int 194
Duration @ .200	Exh 196.8	Exh 196
Lobe Separation	104.5	104
Opening @ .050	Int 36.6	Int 36
Opening @ .050	Exh 72.7	Exh 72
Closing @ .050	Int 64.2	Int 64
Closing @ .050	Exh 41.1	Exh 42

Measure Exhaust Lobe

To start measuring the Exhaust lobe, click on the Exhaust #1 tab at the top of the Main Screen.

DO NOT REMOVE THE DEGREE WHEEL FROM THE CRANK OR ADJUST THE DEGREE WHEEL OR POINTER.

This ensures you keep cam timing between the intake and exhaust lobes the same. Move the dial indicator to the exhaust lifter and rotate the cam until the lifter is opposite the nose of the exhaust cam. Now set the dial indicator to .000.

Rotate the crank clockwise until you find an even 5 degree reading on the opening ramp. For this cam a Degree Wheel Readings reading of 20 ATDC gives a dial indicator reading of .002". (Note that this is *extremely* early and most cams will start much later.) Click on Generate Degree Wheel Readings as done with the Intake Lobe, and enter 20 and ATDC as the inputs to this screen. See Figure 4.9, page 85. The program will then generate the Degree Wheel Readings points shown in Figure 4.19.

Record Cam Lift data for the exhaust lobe as done with the intake. This exhaust lobe has very gentle opening and closing ramps and therefore has several points (97 to be exact) with greater than .002" Cam Lift. Again, you may want to delete all points after Point #97 by clicking on Point 98 in the Point Column, and clicking on Delete Remaining Rows in the Edit menu.

You should now graph and report the Exhaust data so the Cam Analyzer can do its checks. As with the Intake, all the data looks good. Again you should save your measurements by clicking on File, then Save at the Main Screen.

Conclusions:

1. The New Test command is used to prepare the Cam Analyzer for entering Cam Lift data from a new cam. The program directs you through a series of steps, so details are not overlooked.
2. The Find TDC command directs you through steps to accurately index your degree wheel to the engine.
3. The Generate Degree Wheel Readings command will fill the Degree Wheel Readings column with appropriate readings based on the first Degree Wheel Readings reading you enter.
4. Cam Lift data can easily be entered by taking advantage of the EZ Data Entry screen. This feature will save time and prevent mistakes.
5. You can click on Graph to produce a high resolution graph so you can check the cam profile you have measured. Any mistakes in the Cam Lift data you entered are immediately obvious. This lets you check and correct readings which look "out of line" while you are still set up on the engine.

- 6. Once a lobe is completed, you can check your data with Graphs and Reports. Graphs let you check for "bumps" in the data which can indicate an error in data entry. Reports give lobe centerline and .050" events. If these events do not match the cam grinder's specs, you should double check your data.
- 7. The Cam Analyzer's "filtering" or "smoothing" routines check for points which "are not smooth". You should double check these points and those around these points to be sure you entered the Cam Lift data correctly.

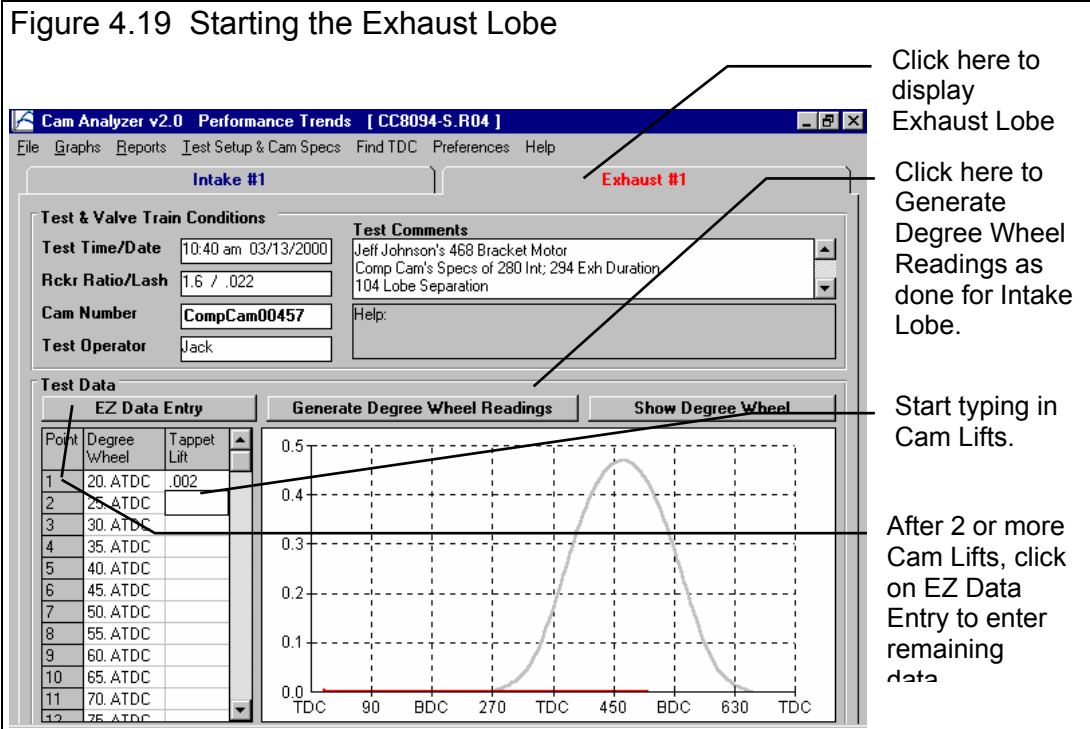

Example 4.2 Analyzing and Comparing Cams

This example will work with a Solid Roller Circle Track cam, the UD6060S.R07 found in the EXAMPLES folder. To open this file, click on File, then Open (from all saved tests) at the Main Screen. Choose the EXAMPLES folder, click on UD6060S.R07, then click on Open to open this file. See Figure 4.20.

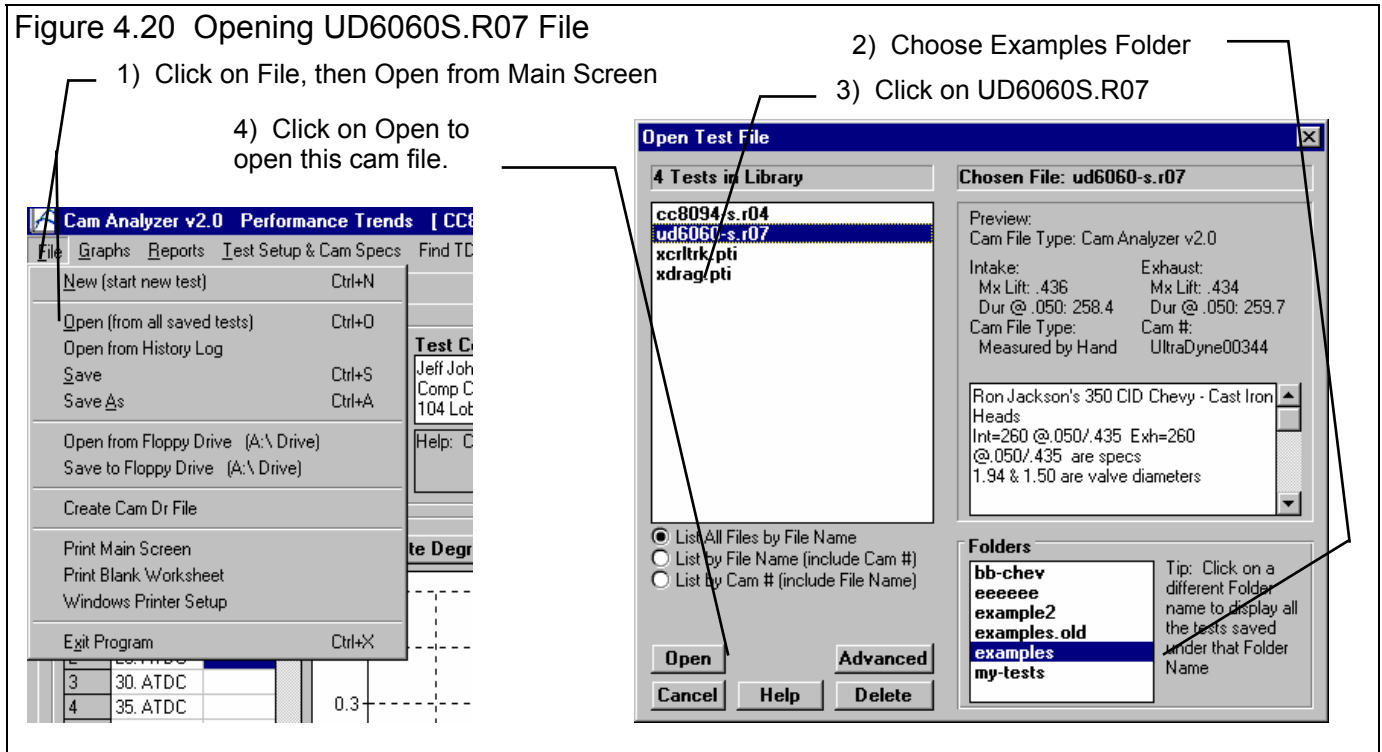

Most all of the Cam Analyzer's features allow you to compare one cam to another. For example, you can print a Duration Report for 2 cams and compare the results. Click on Report at the top of the Main Screen for the Report Menu of Figure 4.21 and select Duration Report as the Type. Figure 4.22 shows 2 Duration reports, one for the UD6060S.R07, and another for the XDRAG.PTI cam.

Another useful feature is to compare 2 or more cams graphically on the Graph screen. For example, let's compare the intake lobe of the UD6060S.R07 to the XDRAG.PTI (same as CC8094S.R04) cam from Example 4.1.

Click on Graph at the top of the Main Screen and select Intake Cam Data as the Graph Type. See Figure 4.23. Set only Graph Lift to Yes so you will only graph Cam Lift. Set Lift Filtering to Some (since this profile was also measured by hand) and Vel/Accel/Jerk Filtering to None. Then click on Make Graph to produce the graph of Figure 4.24.

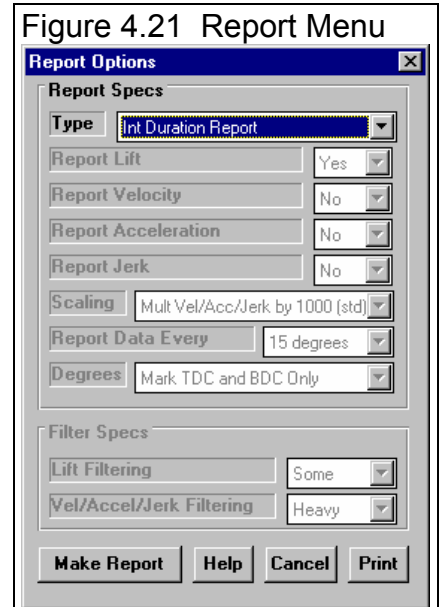

Figure 4.22 Duration Reports

Cam Analyzer v2.0 Performance Trends [UD6060-S.R07]

Report of: Cam Data Test Time: 10:21 AM 03/05/1994 Events Rated at .050" Tappet Lift

CLine	Dur	Open	Close	Lb Area	Lb Lift	Vlv Lift	RAR	Lash	LbSep/Adv	Overlap
Int: 101.8	258.9	28.3	50.6	37.60	.436	.697	1.6	.02	107.1	47.1
Exh: 112.3	260.4	61.5	18.8	37.74	.434	.695	1.6	.022	5.2 Advance	

Lift	Int Open	Int Close	Int Dur	Exh Open	Exh Close	Exh Dur
.003	62.7	85.2	327.9	94.6	-2274.0	-1999.4
.004	60.7	83.0	323.7	92.5	-2274.0	-2001.5
.006	56.8	79.4	316.2	88.7	48.4	317.1
.015	46.9	69.8	296.7	79.6	37.9	297.4
.020	43.2	65.9	289.1	76.0	34.1	290.0
.040	32.5	54.7	267.2	65.6	23.0	268.7
.050	28.3	50.6	258.9	61.5	18.8	260.4
.100	12.8	35.2	228.0	46.3	3.2	229.5
.150	0.5	23.2	203.8	34.5	-9.0	205.5
.200	-10.4	12.4	182.1	23.8	-20.4	183.4
.250	-21.2	1.5	160.3	12.8	-31.8	161.0
.300	-33.1	-10.5	136.4	0.7	-44.2	136.5
.350	-47.3	-24.6	108.1	-13.2	-58.6	108.2
.400	-66.8	-43.4	69.8	-32.7	-78.2	69.1
.450						
.500						

Cam Summaries at the top of the Reports screen contain much data for comparing cams.

Intake and Exhaust duration can be compared at most any lift.

Cam Analyzer v2.0 Performance Trends [XDRAG.PT1]

Report of: Cam Data Test Time: 12:42 PM 02/07/1994 Events Rated at .050" Tappet Lift

CLine	Dur	Open	Close	Lb Area	Lb Lift	Vlv Lift	RAR	Lash	LbSep/Adv	Overlap
Int: 103.3	280.8	36.6	64.2	42.23	.469	.704	1.5	.020	104.6	77.8
Exh: 105.9	293.8	72.7	41.1	40.89	.423	.676	1.6	.022	1.3 Advance	

Lift	Int Open	Int Close	Int Dur	Exh Open	Exh Close	Exh Dur
.003	84.1	110.2	374.3	155.0	132.7	467.7
.004	82.2	108.1	370.3	149.7	125.7	455.4
.006	78.5	104.2	362.7	139.8	115.1	434.9
.015	64.1	90.6	334.7	101.7	73.8	355.6
.020	58.0	84.6	322.6	93.9	64.2	338.2
.040	42.1	69.3	291.5	78.0	46.8	304.8
.050	36.6	64.2	280.8	72.7	41.1	293.8
.100	18.0	46.0	243.9	53.1	21.0	254.1
.150	4.4	32.6	217.0	38.2	5.8	224.1
.200	-7.4	21.0	193.6	24.7	-7.9	196.8
.250	-18.6	9.7	171.1	11.1	-21.6	169.5
.300	-30.0	-1.7	148.4	-3.5	-36.0	140.5
.350	-42.4	-14.3	123.2	-20.4	-52.9	106.7
.400	-57.3	-29.5	93.2	-44.2	-76.6	59.2
.450	-79.0	-51.6	49.4			
.500						

Table 4.2 Cam Comparisons from Report Data

Specification	Circle Track Int	Circle Track Exh	Drag Int	Drag Exh
Duration at .050"	258.9	260.4	280.8	293.0
Duration at .200"	182.1	183.4	193.6	196.8
Lobe Area	37.60	37.74	42.23	40.89
Lobe Lift	.436	.434	.469	.423
Lobe Sep/Overlap	107.1	47.1	104.6	77.8

Click on Add Test at the top of the Graph screen, shown in Figure 4.24. This opens up the Open screen very similar to that shown in Figure 4.20 where you can select the XDRAG.PTI cam. Click on XDRAG.PTI to highlight it, then click on Open to select it for graphing. You will be returned to the graph screen, now with 2 intake lobes.

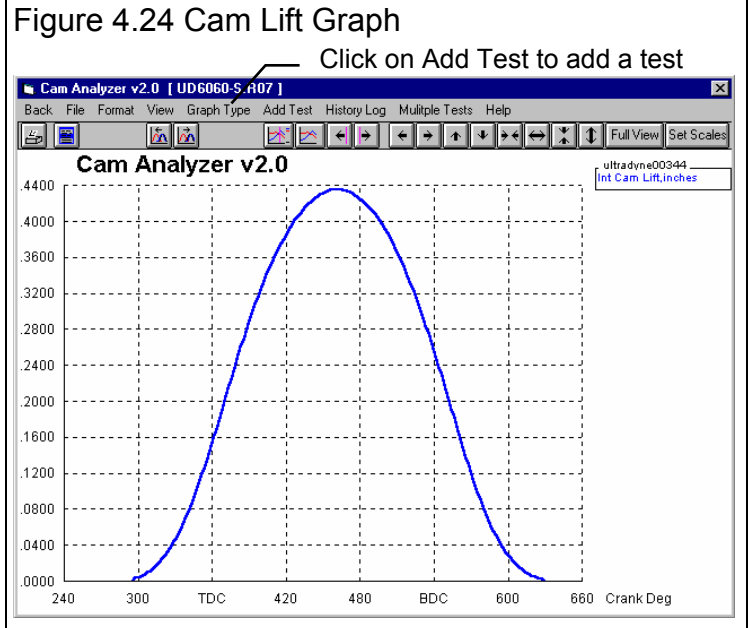
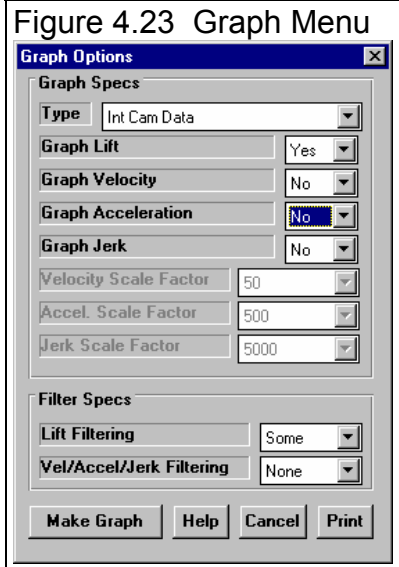

Background: Actually, what the Add Test is doing is adding this test to the top of the History Log, and placing a Yes in the 'Graph?' column. If XDRAG.PTI was already in the History Log because you had recently worked with it, you could have just clicked on History Log and placed a Yes in the 'Graph?' column to graph it.

This graph shows that the XDRAG.PTI cam has higher lift and more lobe area. It also shows XDRAG.PTI opens somewhat earlier and closes much later.

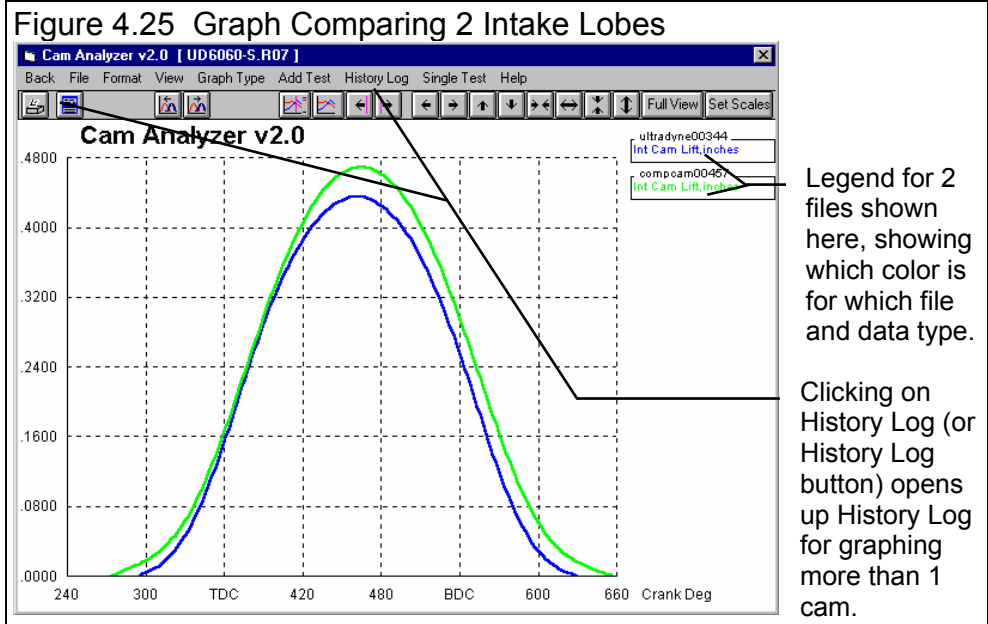

Figure 4.26 History Log Which Determines Which Files are Graphed

All cam files you have recently worked with (graphed, started new, opened for review or analysis) appear here in chronological order.

Test File and Path	Graph?	Std Graph Title	Save?	Cam #	Int Lift	Dur	Test Date
\examples\ud6060-s.r07	Yes	ultradyne00344		UltraDyne00344	.436"	258.4	03/05/1994
\examples\xdrag.pti	Yes	compcam00457		CompCam00457	.470"	279.7	02/07/1994
\examples\xdrag.pti		compcam00457		CompCam00457	.470"	279.7	02/07/1994
\bb-chev\cc8094-s.r04		ccsr0047		CCSR0047	.005"	.0	03/18/2000
\examples\xctrlk.pti		reed00022	Yes	Reed00022	.436"	258.4	03/05/1994
\examples.new\xdrag.pti		compcam00457	Yes	CompCam00457	.470"	279.7	02/07/1994
\examples.new\xctrlk.pti		reed00022		Reed00022	.436"	258.4	03/05/1994
\examples.new\ud6060-s.r07		ultradyne00344		UltraDyne00344	.436"	258.4	03/05/1994
\examples.new\cc8094-s.r04		compcam00457		CompCam00457	.470"	279.7	03/13/2000

Click in this column to add a Yes (or click on a Yes to remove it) to state which of these files you want graphed.

The program uses this Std Graph Title to label this cam in the graph. You can click on this title to change it to most anything you want of 16 characters or less.

Click in 'Graph?' column to select or de-select tests for graphing. Slide button right for more History info. (Dur. meas. at .050")

Figure 4.27 Shifting Graphs With Respect To Each Other

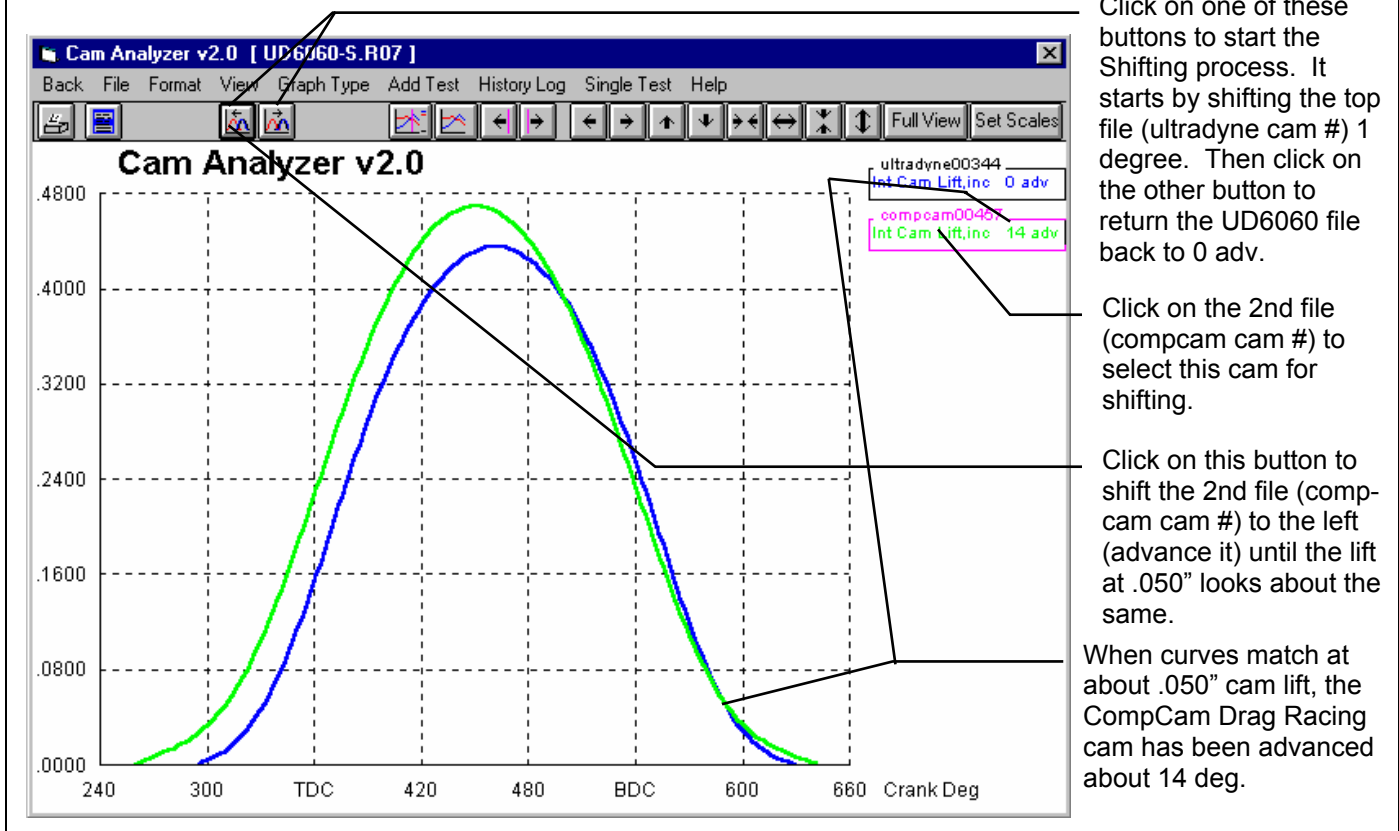

Let's say we want to see what the profiles would look like if both had approximately the same intake closing @ .050" events. See Figure 4.27 for the steps to accomplish this. As Figure 4.27 shows, you would have to advance the drag racing cam 14 degrees to obtain approximately the same intake closing events at .050" lift. Figure 4.28 shows how you could "zoom in" on just the closing ramp to see it in more detail.

Figure 4.28 Zooming In On a Section of the Graph with the Mouse

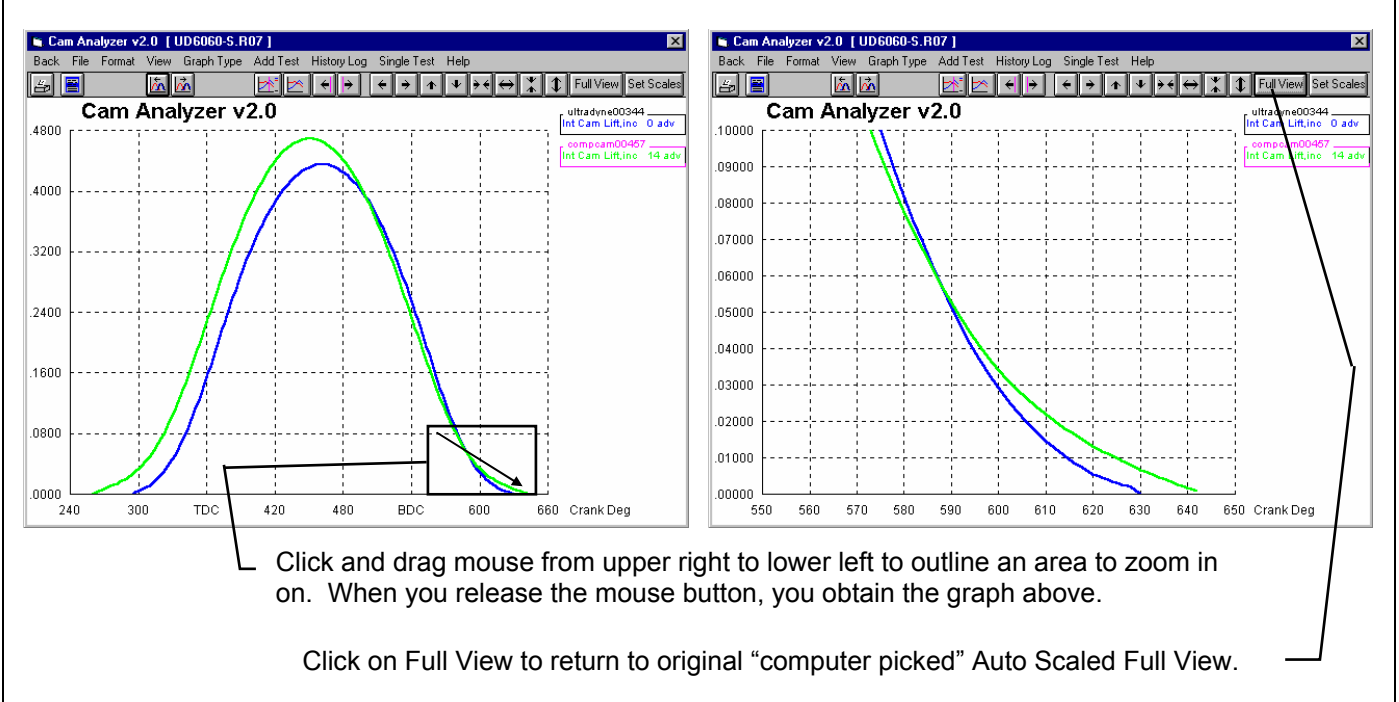
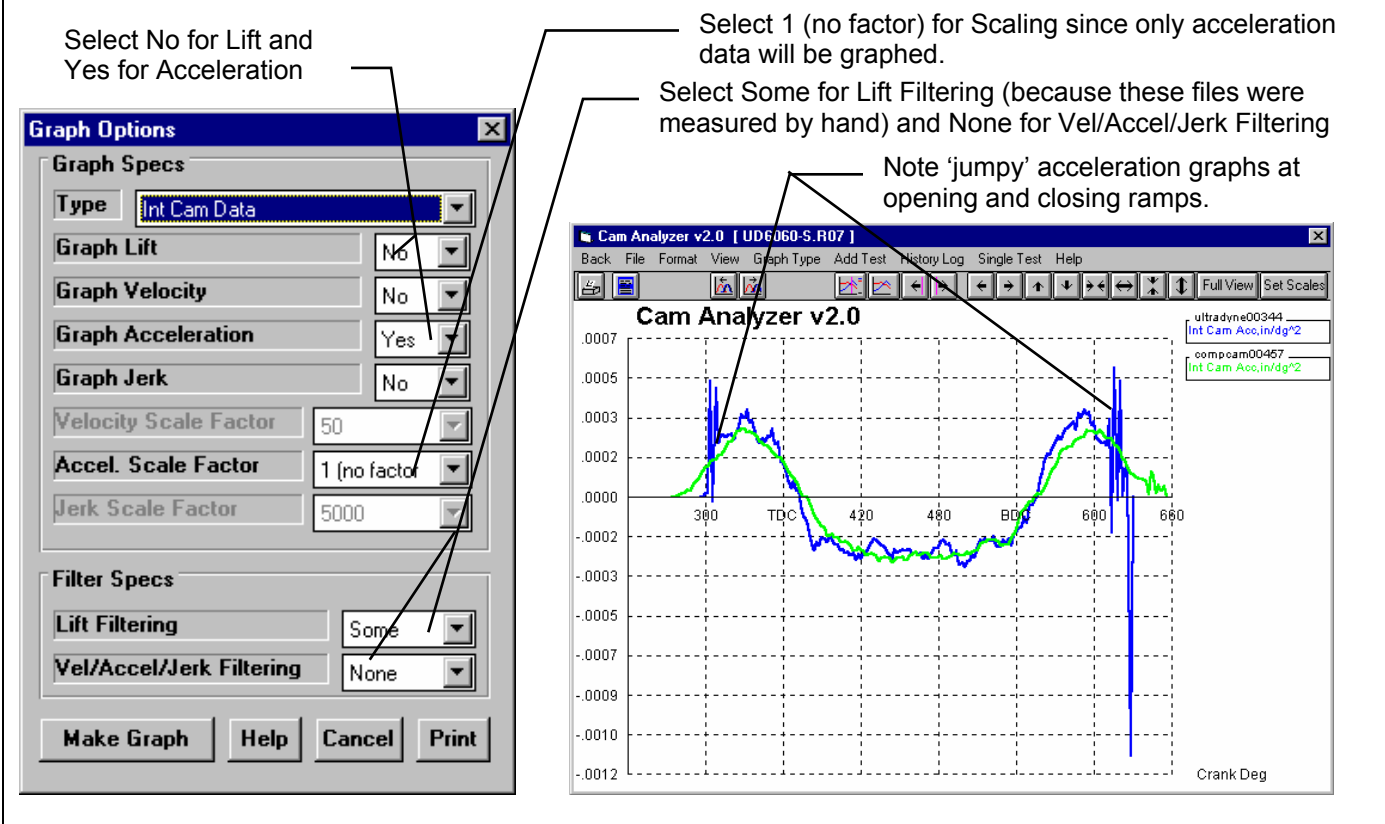

Figure 4.29 Comparing Acceleration Graphs, Filtering Set to "None"



Another useful comparison between cams is to compare acceleration curves. Figure 4.29 shows how you could compare only the intake acceleration curves. Figure 4.29 shows a very “jumpy” acceleration graph. To get rid of some of the “jumpiness” in the acceleration graphs, click on Graph Type at the top of the graph screen, and select Moderate for the Vel/Accel/Jerk Filtering level. Figure 4.30 shows the same acceleration graphs but with Filtering set to Moderate.

To determine the exact acceleration rates at certain points, we will use the "cursor" feature. Click on one of the acceleration graphs to display the vertical line cursor, or click on one of the cursor buttons. The exact acceleration values at the cursor appears in the graph legend on the right side of the graph. Figure 4.30 shows the cursor at the maximum positive acceleration point on the opening ramp. For the on UltraDyne circle track cam it is .00032 and for the Comp Cam drag racing cam it is .00028. This tells you that the maximum positive acceleration is approximately .33 thousandths inch per cam degree per cam degree and occurs at 330 crank degrees (30 degrees BTDC). Table 4.3 shows some other maximum acceleration points for both cam profiles.

Table 4.3 Maximum Cam Accelerations

Cam	Max + Opening	Max -	Max + Closing
Circle Track UltraDyne	.32	-.27	.34
Drag Racing CompCam	.28	-.27	.28

Figure 4.30 Using Cursor to Find Exact Acceleration Values, Filtering set to "Moderate"

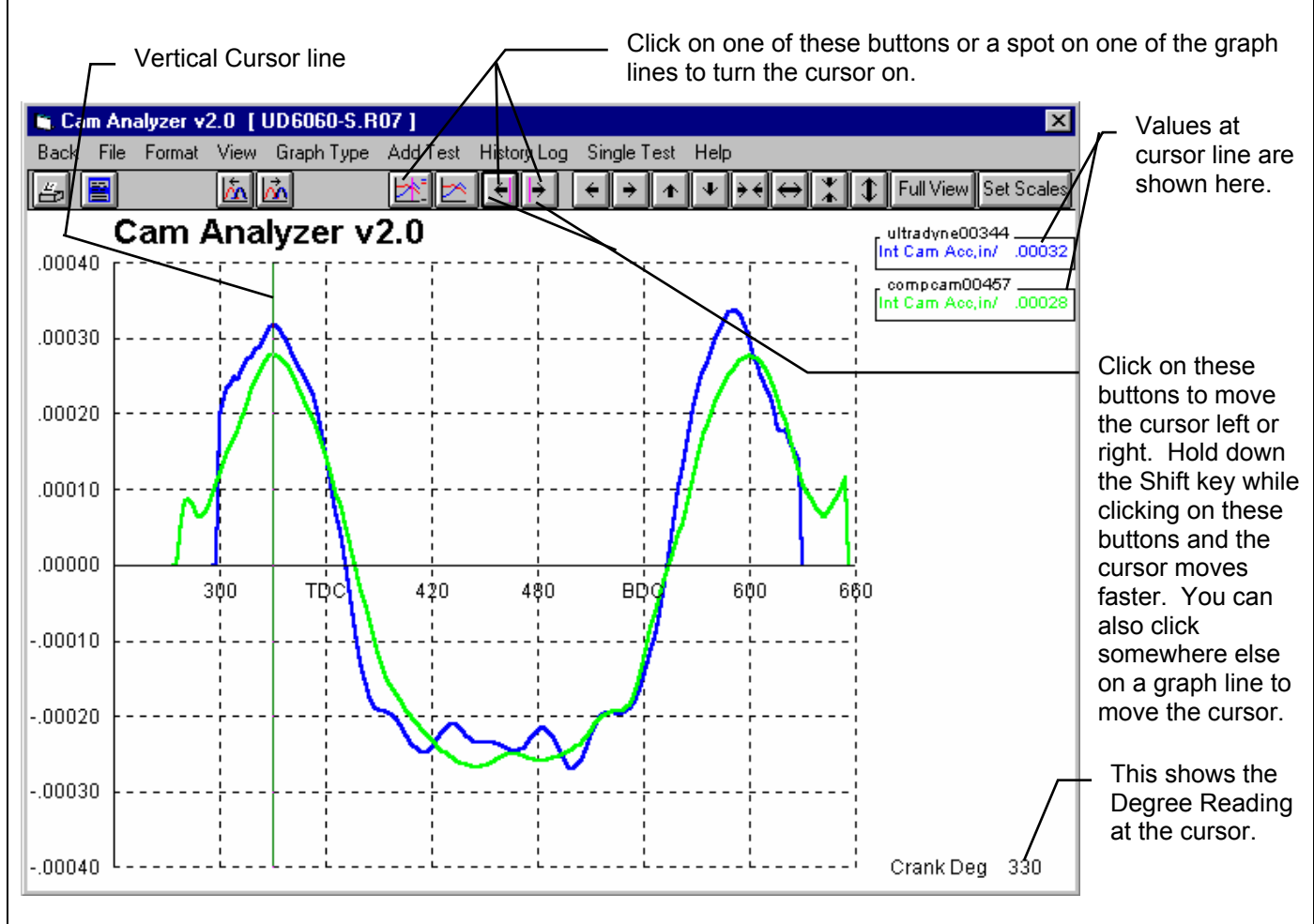

Table 4.3 shows that the Circle Track cam has slightly higher acceleration rates on the opening and closing ramps than the Drag Racing cam. These differences in acceleration rates can mean:

- The Drag Racing cam was designed for a higher RPM range than the Circle Track cam. The Circle Track's higher acceleration rates can only be tolerated at lower RPM.
- At the same engine RPM with equal weight valve train components, the Circle Track cam would be harder on valve train components. That is primarily due to its higher + acceleration rates on the opening and closing ramps.
- At the same engine RPM with equal weight valve train components, the Circle Track and Drag Racing cam would require approximately the same spring rates. That is primarily due to both cams having approximately the same acceleration rates over the nose of the cam. In general, the higher the - acceleration rate, the more spring pressure required to keep the tappet in contact with the cam, especially over the nose of the cam.

Conclusions:

- Measured cam profiles can be compared 2 ways:
 - Comparing calculated specs like duration at various lifts, Lobe Area, etc. calculated from the various reports.
 - Making graphs where lift, velocity or acceleration from 2 or more different cams can be graphically compared on one graph.
- Several graph options like zooming, shifting, graphing more than 1 file, cursor feature, etc. make it easy to manipulate the graphs and pin-point certain areas of a graph.

Appendix 1: Accuracy and Assumptions

Accuracy:

The accuracy of the Cam Analyzer's cam measurements like Lobe Area, Int Opening at .050", Duration @ .200" depend on:

1. Accurately finding TDC and setting the degree wheel to TDC
2. Accurately setting the crank and cam to the Degree Wheel Readings points.
3. Accurately recording tappet Cam Lift.
4. The number of data points you record. The more points (the lower the Deg Steps), the more accurate the results.

The following "Tips for Accurate Measurements" will help you with the first three requirements. The section Effect of Deg Steps discusses the fourth point.

Tips for Accurate Measurements

1. Double check your measurements

When finding TDC and you have found the 2 degree wheel points, one on each side of TDC, rotate the crank to these readings again and see if they repeat.

If you have just set the degree wheel and pointer to read TDC, check that this agrees with your previous TDC or spark timing marks. For example, when your degree wheel and pointer are set to TDC, do the timing marks on the damper also read TDC. (You may have to remove the degree wheel and install the damper temporarily to check this.) If they agree, then the original marks and your degree wheel and pointer setting are most likely both correct. If they do not agree, repeat the procedure for finding TDC.

When you just finished recording the last Cam Lift point on the closing ramp, continue rotating the crank/cam to the opening ramp. Check that your first couple of Cam Lift readings on the opening ramp still agree with Cam Lift readings you recorded.

2. Always rotate the crank in the correct direction

There is considerable "slop" in most cam drive systems. For this reason, you must always keep rotating the crank in the same direction when setting Degree Wheel Readings points. If you go past a certain Degree Wheel Readings point you must back up the cam and crank at least 30 crank degrees, then approach the Degree Wheel Readings point again.

3. The lifter stays in contact with the cam for all Cam Lift measurements.

Before each Cam Lift measurement, apply slight pressure to the lifter to ensure it is touching the cam profile.

4. Use the correct lifter.

Always use the lifter designed for the cam being measured. Flat tappets on roller cams or vice versa, or the wrong roller tappet roller diameter will give very different Cam Lift measurements for exactly the same cam profile.

5. Securely attach the dial indicator.

The easier it is to set up your dial indicator, the more accurate your measurements. If you have to "hold your breath" for each Cam Lift measurement hoping the dial indicator does not shift, your measurements will not be accurate. Take some time to make a dial indicator extension, or purchase a special tool from your cam grinder so the dial indicator accurately reads tappet Cam Lift. Make a stand which bolts to the engine where the dial indicator base can set securely. Be sure the dial indicator probe is parallel to the lifter bore.

Effect of # Deg Steps and Comparison With Computerized Cam Checking Systems

Graphs shown in this section are from the DOS version 1.1, but results are the same with Windows Version 2.0. The Windows version does not allow some of the Deg Steps allowed by the DOS version shown here (like 6, 8 or 16 degrees) but the trends are the same in the Windows version for the Deg Steps possible in the Windows version.

The Cam Analyzer does not assume each Degree Wheel Reading and Cam Lift data point is exactly accurate. It assumes you could be off slightly for each reading. The more points you record and the smaller the Deg Steps, the less important are these minor errors, and the more likely the filtered or smoothed cam profile is accurate.

In addition, the rate at which the filtered cam profile can "bend" also depends on the Deg Steps. For example, the Cam Analyzer may require 5 points to allow the cam profile change from being flat to rising straight up at a 90 degree angle. If Deg Steps is 10, it would take 50 degrees to let this cam profile change occur. However, at Deg Steps = 4, it would take only 20 degrees.

See Figure A1 for an illustration. It shows with Deg Steps = 6, the filtered cam profile is very close to the "true profile", but with Deg Steps = 20 there is a big difference the filtered and the "true profile".

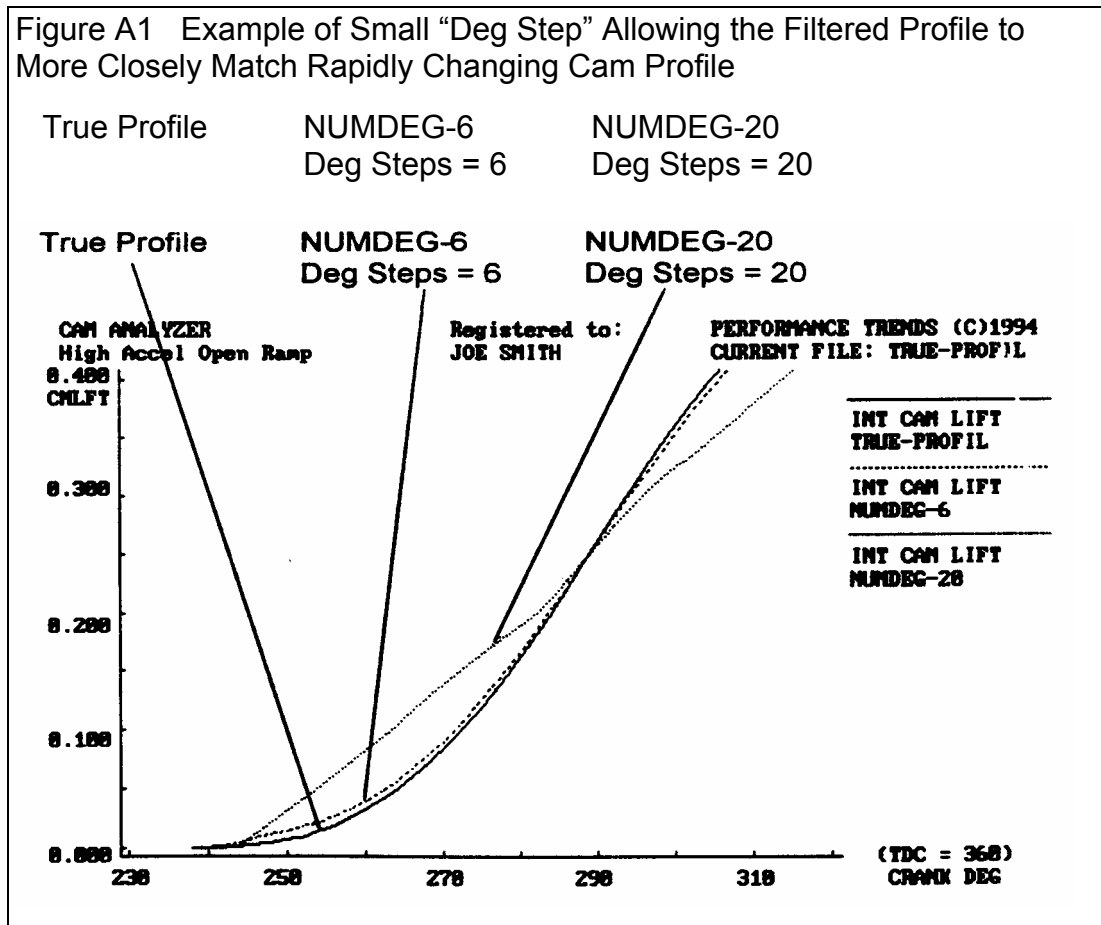

To summarize, using smaller Deg Steps increments help in 2 ways:

1. With more Cam Lift measurements, each single measurement is not as critical, so small measurement errors are not as critical.
2. The filtered cam profile can change direction over a smaller span of crank degrees and more accurately follow the measured cam profile.

The advantages of a smaller Deg Steps can be best explained with an example. Figure A2 and A3 show comparison graphs of the same intake cam profile's lift and acceleration graph. For each successive graph, the Deg Steps was doubled (only half as many readings were taken). For the titles SG-P30-4, SG-P30-8, SG-P30-16, the Deg Steps were 4, 8, 16 respectively. Calculated results for each profile are listed in Table A.1

For all graphs and calculations, the REPORT & GRAPH OPTIONS of FILTER Cam Lift CURVE and FILTER VEL/ACCL were set to Y and 2 as recommended for most situations. Also, VEL was eliminated from the graphs by setting VEL SCALE FACTOR to 0. (These were specs used in the older DOS program.) For comparison, results and graphs were made from Cam Dr measurements. The Cam Analyzer results were based on these Cam Dr measurements, but only to the nearest .001 inch. Figure A4 shows graphs from the Cam Dr's software and Figure A5 shows graphs from Cam Pro's calculations using the Cam Dr data.

Table A1 Cam Analyzer Analysis versus Computerized Methods

Cam Analysis	Dur @ .050"	Lobe Area	Max Lift	Opening Ramp Pk Accel	Nose Pk Accel	Closing Ramp Pk Accel
Cam Analyzer, 4 Deg Steps	288.0	43.83	.477	.264	-.261	.260
Cam Analyzer, 8 Deg Steps	289.9	43.83	.476	.250	-.257	.250
Cam Analyzer, 16 Deg Steps	295.9	43.78	.469	.225	-.250	.227
Cam Dr with Cam Dr measurements	287.5	43.85	.478	.262	-.260	.267
Cam Pro with Cam Dr measurements	287.0	43.85	.477	.266	-.263	.268

Note: The Cam Dr and Cam Pro both analyzed the same cam measurements, made with the Cam Dr measurement system. Cam Dr is a trademark of Quadrant Scientific Inc. Cam Pro is a trademark of Audie Technology.

Figure A2 Intake Cam Lift & Acceleration for Deg Steps = 4

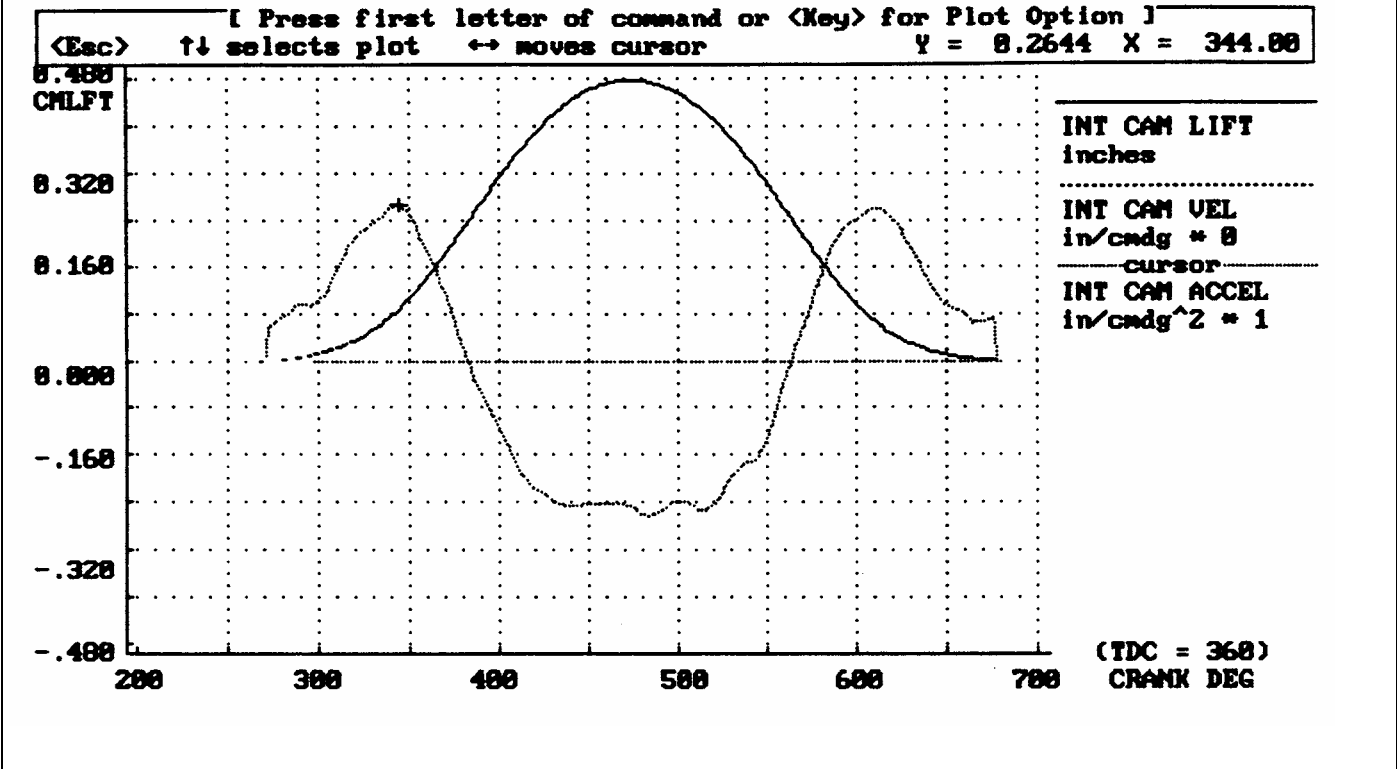

Figure A3 Intake Cam Lift & Acceleration for Deg Steps = 8

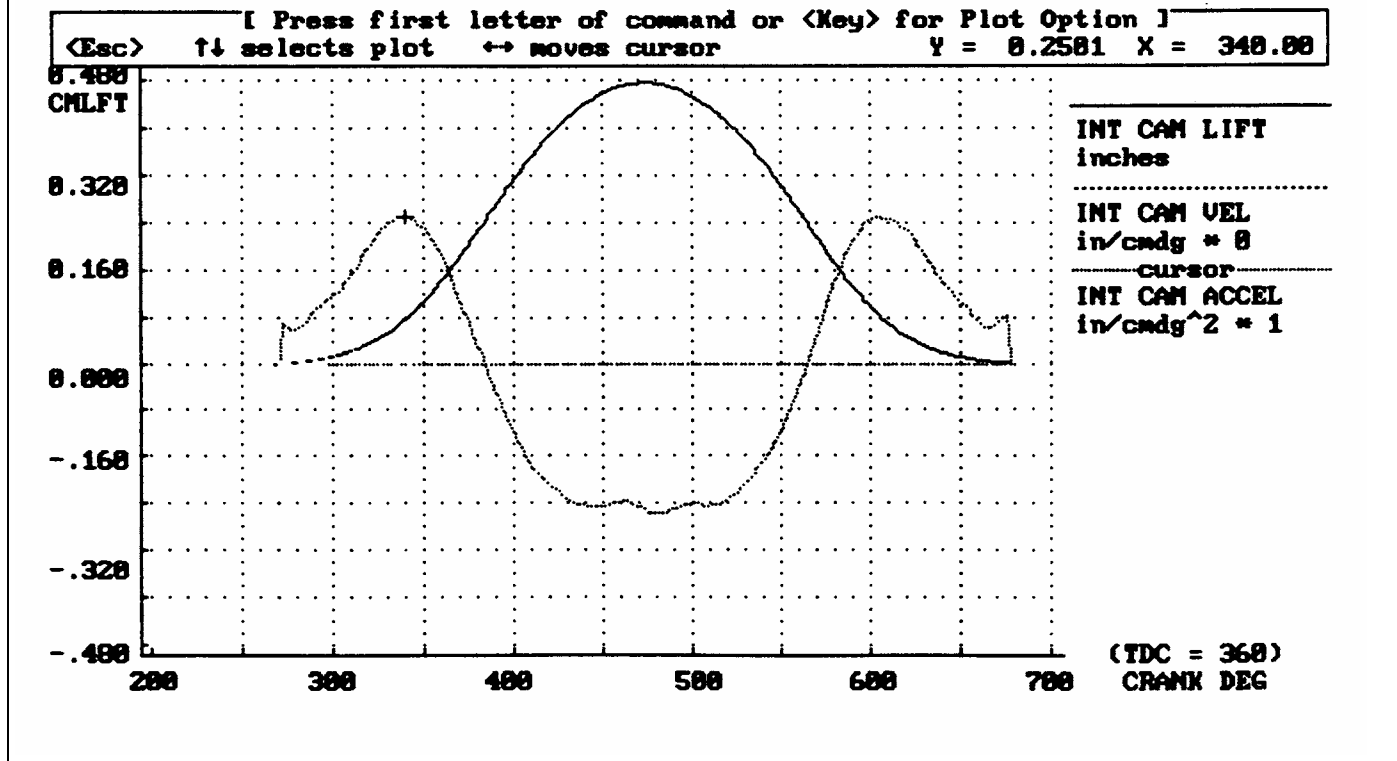
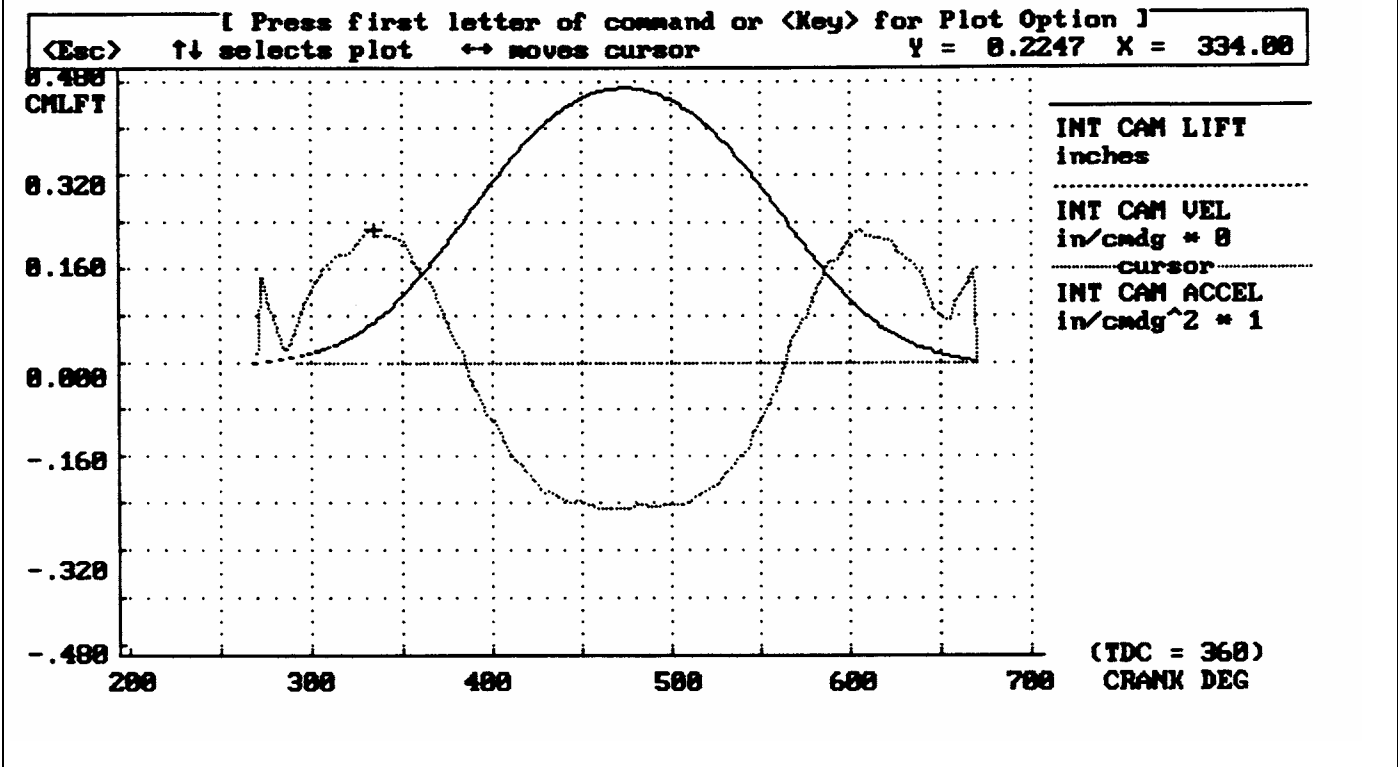

Figure A4 Intake Cam Lift & Acceleration for Deg Steps = 16



As Table A1 shows, the Cam Analyzer results compare very closely with the computerized methods when Deg Steps = 4, and fairly well when Deg Steps = 8. When Deg Steps = 16 the error is too high. For example the true duration @ .050" lift appears to be 287-288 degrees. With Deg Steps = 16 the Cam Analyzer measures 296, an 8-9 degree error.

As shown in Example 4.2, acceleration is an important cam profile characteristic. Table A1 shows the Cam Analyzer's accelerations agree well with the computerized systems when Deg Steps = 4. As the Deg Steps increase, the difference between the computerized systems and the Cam Analyzer increase. For example, when Deg Steps = 16, acceleration on the opening ramp is .225, over 15% less than the true value of approximately .265.

With Deg Steps = 4, the Cam Analyzer's acceleration graph also matches the computerized systems quite well. Note the "bumps" in the negative acceleration curve are the same with the Cam Dr, Cam Pro and Cam Analyzer (Deg Steps = 4) graphs.

Conclusions:

- From these examples, it is obvious that you must keep the Deg Steps low for optimum accuracy.
- With care taking measurements and using a low Deg Steps (2, 4 or 5), the Cam Analyzer can give nearly the same results as computerized systems.

Figure A5 Cam Dr Intake Cam Lift and Acceleration (intake lift graph is the right graph)

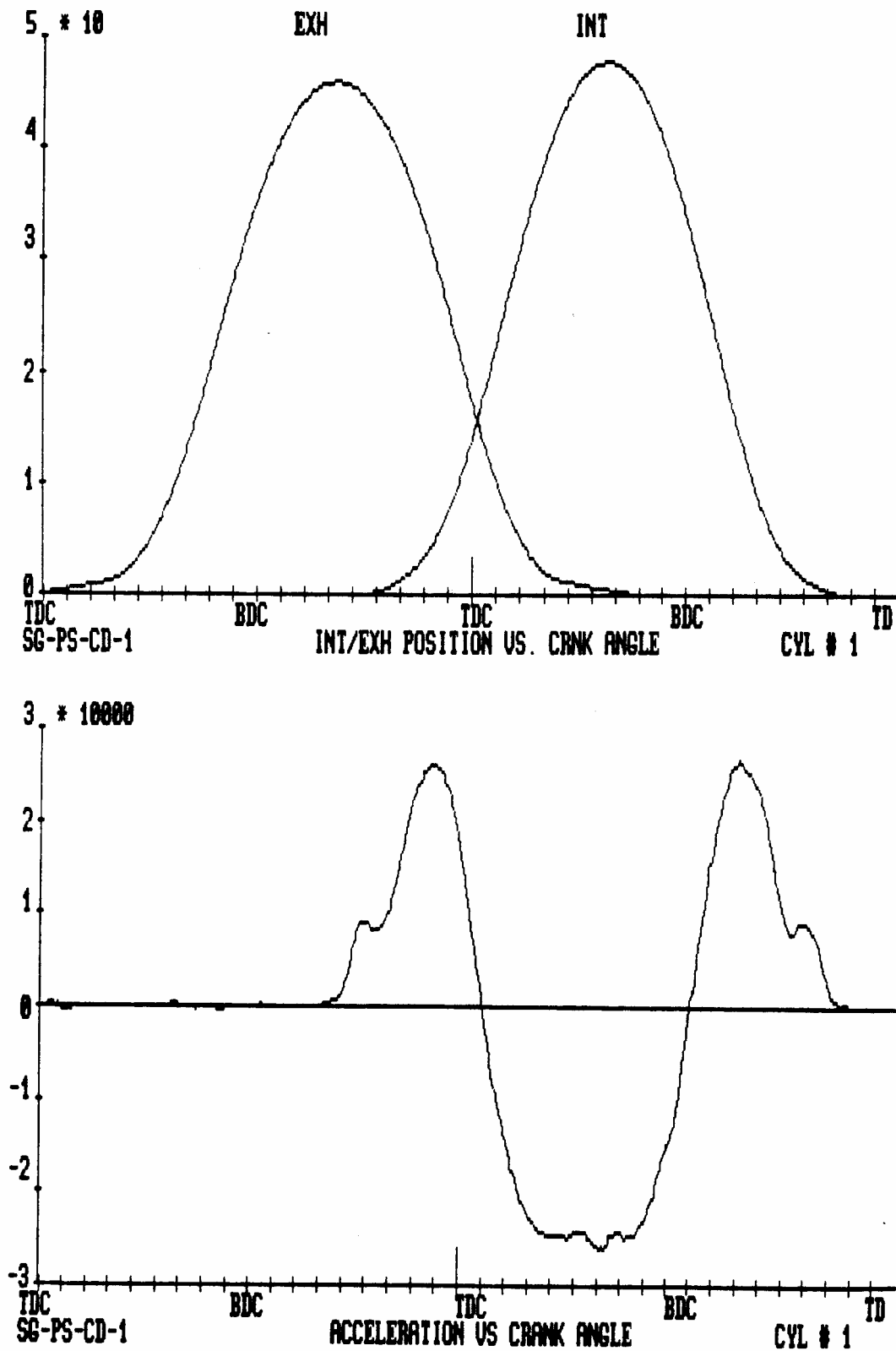
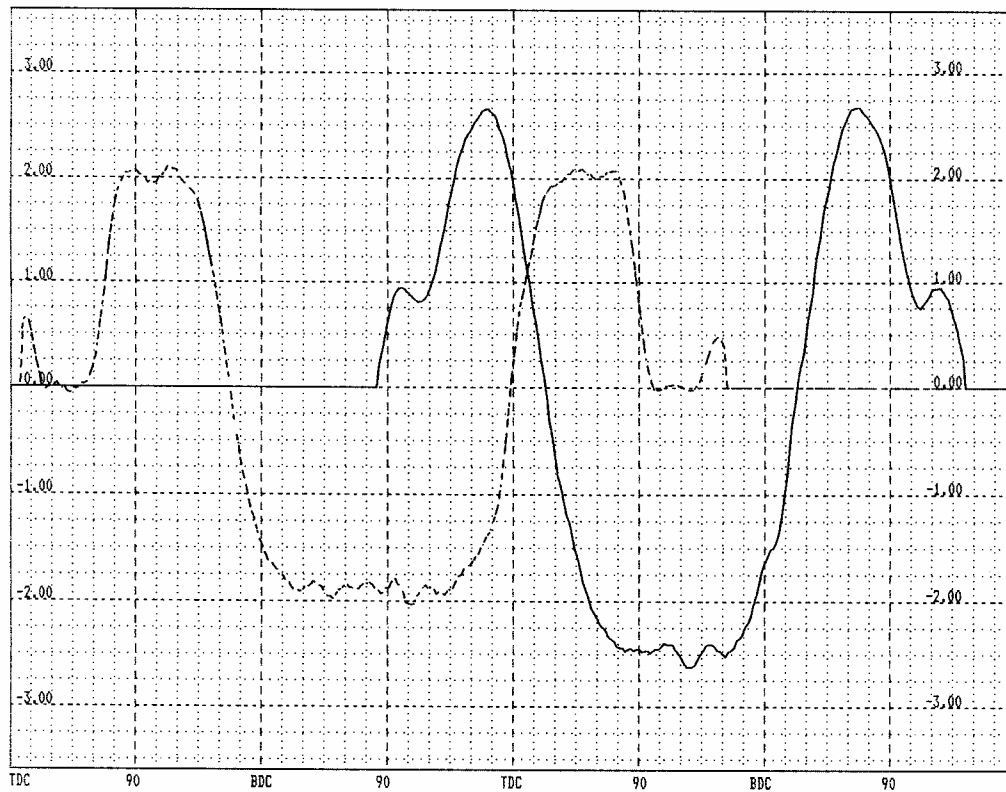
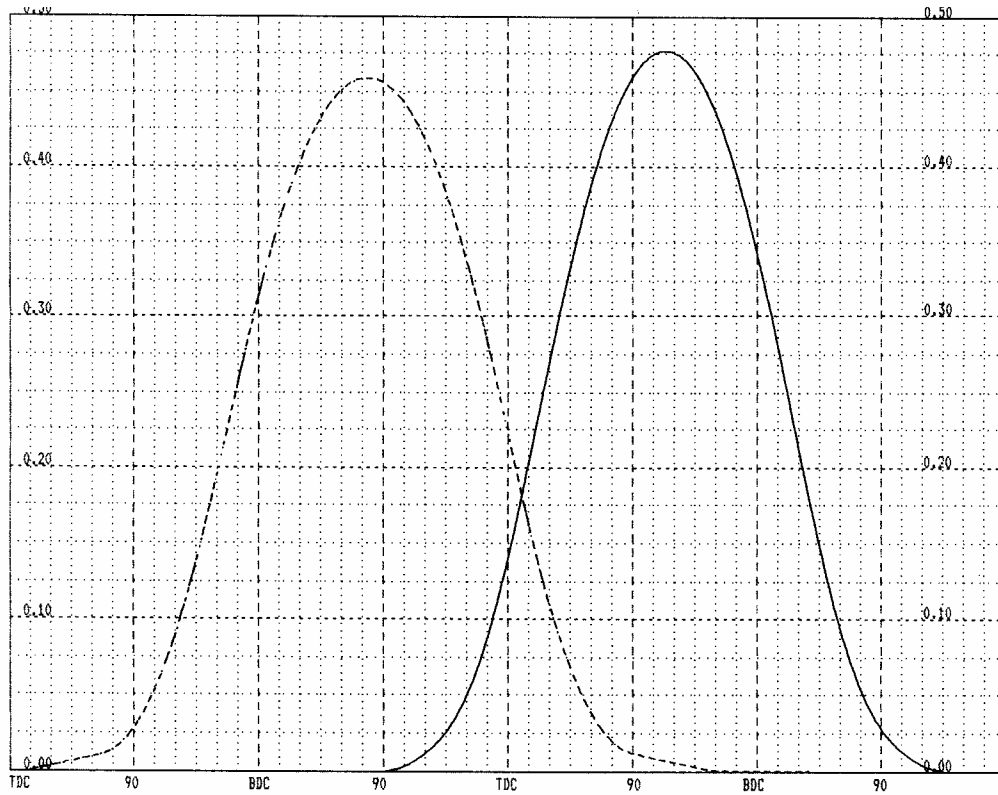

Figure A6 Cam Pro Cam Lift and Acceleration (intake graphs are the right graphs)



Appendix 2 Backing Up Data

Check Appendix 5 for several recently added Backup and Restore features.

Backing up data means to make more than one copy of the data which can be used or referred to at a later date. This may be needed in the event one copy becomes lost or erased, or you need room in the Cam Library. Backing up data can take 2 basic forms:

- Paper Reports
- Copying files with Windows copy commands

Other than making Paper Reports, backing up data requires knowledge of Windows File Manager (3.1) or Windows Explorer (95, 98, NT) commands. Unless you are experienced with Windows commands, have someone experienced with Windows assist you to prevent losing data.

Paper Reports:

If you already keep written copies of all cam measurements you perform, you already understand this form of backing up data. When you finish a cam, simply print out an Int & Exh Raw Data Report. In the Print options menu, be sure to check Include Test Setup. This paper Report contains nearly all the data you need to reproduce this cam in the future. Simply store this paper Report in a safe place.

Disadvantage of Paper Back Ups:

For example, say you have accidentally erased a Cam File but have a paper Report of that data. If you now want to recalculate that data, correct the data to a new Test Pressure, compare new data to this old data, etc, you must re-enter all that RAW data by hand as if you were running a cam test.

Copying data to disk with Windows commands:

This method is the preferred method. If you are not familiar with Windows commands, have someone help you the first couple of times. However, ***this is the most reliable and most efficient way to back up your data.***

Note: Unless stated otherwise, all mouse clicks are with the normal, left button on the mouse.

To copy Entire CAMDATA Folder using Windows 95, 98 or NT, which contains all folders and cam files in the Test Library:

Click on Start, then Programs, then Windows Explorer (usually at the bottom of the list of programs). You will obtain the Windows Explorer screen shown in Figure A5.

Locate the PERFTRNS.PTI folder (may not be printed in capital letters) on the left side of the Windows Explorer screen, usually on the C drive. Click on the [+] sign to the left of it to display the contents of the PERFTRNS.PTI folder.

You should now see the CA20 folder. Click on the [+] sign to the left of it to display the contents of the CA20 folder.

You should now see the CAMDATA folder. Right click on the yellow CAMDATA folder icon to display the menu of options. Click on the Copy command to copy this entire folder (all cam files in the standard Test File Library).

Figure A5 Copying Files with Windows 95, 98 or NT Windows Explorer

Find the CA20 folder under the PERFRTRNS.PTI folder, usually on the C drive. Click on the [+] box to the left of a folder to show its contents (folders).

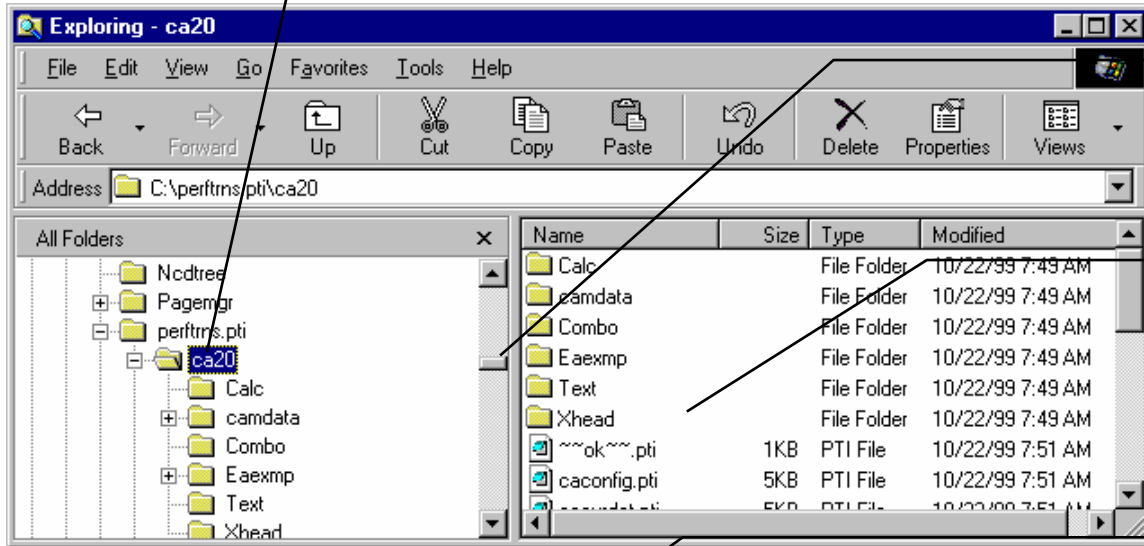

Click and drag the slide bar button to move up and down the list of folders.

The contents of the open (clicked on) folder on the left is shown here, including both folders and files.

Right click (with the right mouse button) on the CAMDATA folder (not seen here) to open a menu of options.

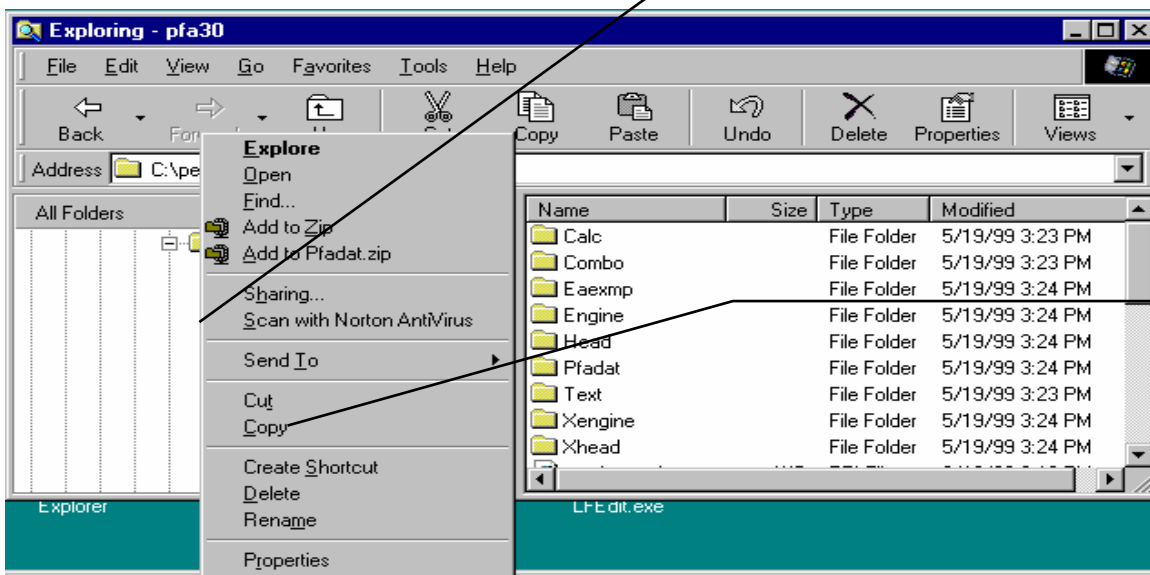

Click on Copy to copy the entire contents of the CAMDATA folder (the entire test file library). DO NOT click on Cut.

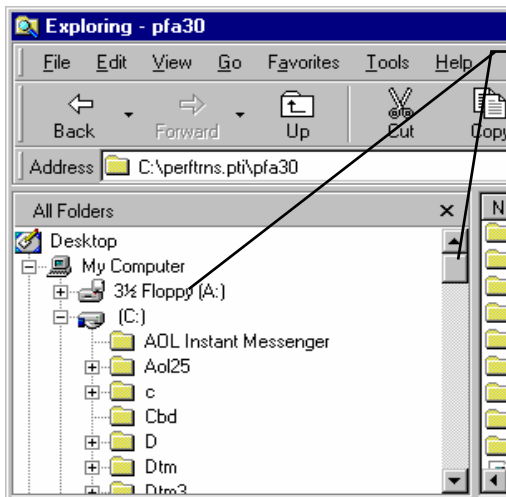

Drag slide bar to the top of the list to find your Floppy disk drive (usually A)

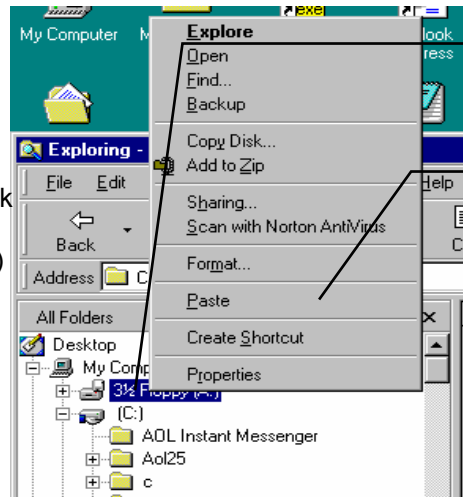

Right click on the Floppy drive icon.

Then click on Paste to paste whatever you copied (in this example, the entire CAMDATA folder) to the disk in the Floppy drive.

Now you must tell the computer where you want to copy the files to. Click and drag the slide bar for the left section of the Windows Explorer screen to the top. (You can also click on the up or down arrow buttons on the slide bar.) Look for the Floppy Drive icon, usually the "A" drive. Put a new, formatted disk in the floppy drive. Then right click on the Floppy Drive icon, and select Paste from the list of options. You will see the floppy drive light come on as the entire CAMDATA folder and all its contents are copied to the floppy disk. Label this disk with something like "CAMDATA folder, xx/xx/xx" with a name and date.

Notes:

If you have many cams in the Test Library, they may not all fit onto 1 floppy disk. Windows Explorer will tell you this and ask you to insert another new, formatted disk. If this happens, be sure to label all disks with a name, date and sequential #s, and keep the entire disk set together. A suggestion for novice computer users is to make each folder under CAMDATA a separate floppy disk. This may require more floppy disks, but will make it easier to understand restoring just certain folders in the future.

You may just want to back up one particular folder in the cam library (in the CAMDATA folder) or just 1 particular cam. You would do this the same as with copying the entire CAMDATA folder, just click on the [+] by the CAMDATA folder to display the folders under CAMDATA. Then right click on the folder you want to Copy. To find individual cam files, click on the yellow folder icon containing the cam file and the contents of the folder will be shown on the right side of the Windows Explorer screen. Then right click on the cam file name and select Copy.

You can also copy individual cam files to the floppy drive inside the Cam Analyzer program. Open the file you want to copy so it is the current cam file. Then click on File at the top of the Main Screen, then select Copy to Floppy Disk.

More experienced computer users may want to use the "Backup" features built into Windows 95 and 98 (click on Start, Programs, Accessories, System Tools, Backup). This compresses cam files so it takes fewer floppy disks. However you need to use the Backup program to restore cam files, which can be more confusing to novice computer users.

Restoring Data

Be very careful when restoring data, as you may overwrite Test Files with old, erroneous information. Read all the information below before restoring data. If you are not familiar with Windows Explorer, have someone more experienced help you.

The ONLY reason to restore data is if you have lost cam files. This could be because you mistakenly erased them, you had a major computer failure, or you are moving the program to another computer. Do NOT restore data unless you have one of these problems, as you could possibly create many more problems than you are trying to fix.

When restoring cam files and folders, you pretty much reverse the procedure for backing up. First you put your backed up floppy disk in the floppy drive. Then open Windows Explorer, find the Floppy drive icon and click on it to display its contents. Right click on the folder you want to restore and select Copy.

Now find the CAMDATA folder under CA20 under PERFTRNS.PTI, usually on the C: drive. Right click on the folder **1 level up** from the folder you are restoring. For example, if you are restoring the cam file folder CHEV which was in the CAMDATA folder, you must click on the CAMDATA folder. If you are restoring the entire Test Library folder CAMDATA, you must click on the CA20 folder. If you are restoring the cam file 194-150 which was in the CHEV folder under the CAMDATA folder, you must click on the CHEV folder.

During the restoring (copying) process, Windows Explorer checks to see if it is overwriting an existing file (Figure A6). If it is, it will ask you if the existing file or folder should be overwritten. Be very careful when overwriting files, as you may overwrite a new cam file with data from an old cam file of the same name.

Before restoring cam files, it is good practice to back up all cam files first. Then if you make a mistake, and overwrite cam files you didn't mean to, you have your backup copies to restore the cam files from.

Figure A6 Windows Explorer Warnings when Overwriting Test Files

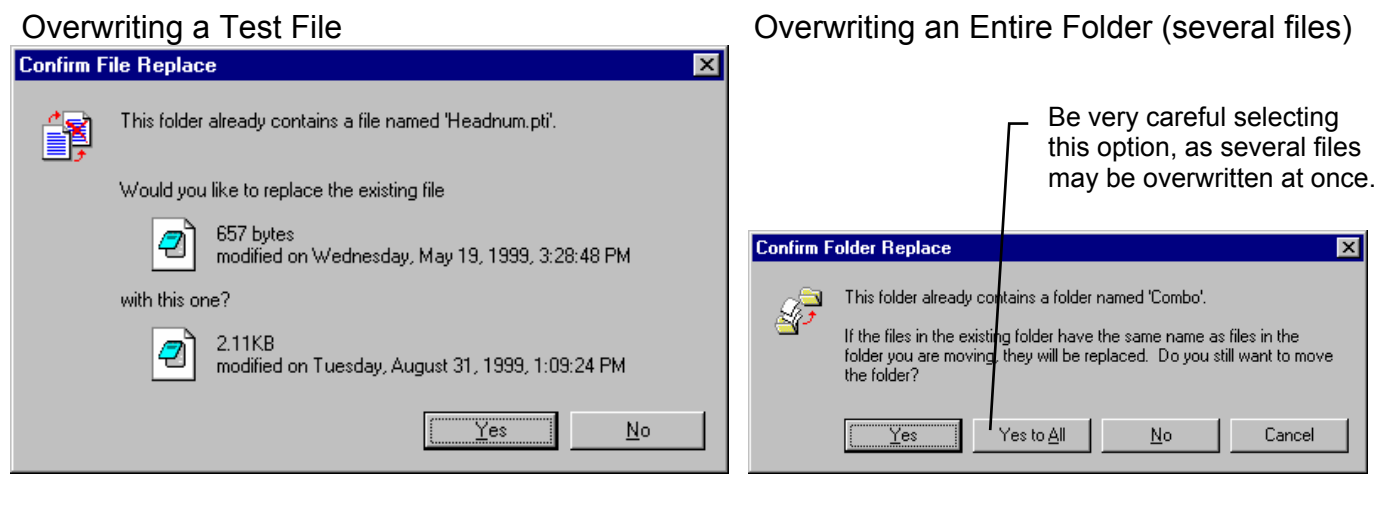

Appendix 3 New Features in Version 3.2

Several new features are included in v3.2, including:

- Full 32 bit version, which is much more compatible with newer printers, printer drivers and operating systems, like XP, 2000, NT4 etc.
- Full 32 bit version lets you use much longer, more flexible file names for saving your files.
- Click on “File”, then “Open from all saved tests” and you have many more features for saving, copying, deleting and renaming folders, which are sets of cam test files.
- You can now write (export) files in Comp Cam’s™ format. This lets you create individual file lobes of intake and exhaust lobes so you can mix lobes from different cam files.
- User manual is now access bile from within the program by clicking on Help at top of the Main Screen, then Display User’s Manual. The program uses Adobe Acrobat™ to display it in PDF format.
- The graph screen now enlarges to fill the entire computer screen.
- You can now select the amount of smoothing the program should do to manually entered cam lift data. For example, data entered at more than every 5 degrees should probably have less than the Std smoothing.
- You can now select to manually enter the degree increments in most any step size you want. This allows you to concentrate the readings in only the area you want (like around .050 lift and peak lift). This is done by selecting User Entered for Degree Steps in Test Setup.
- Program now tries to automatically recognize if a file was recorded with millimeters or inches lift. It then converts it as necessary for the current Preference setting of either millimeters or inches lift.
- Several edit options added at top of main screen.
- Preference added for using either millimeters or inches for lift inputs.
- Added option to Copy To or Paste From the Clipboard the Lift Data Column. Click on Top Row in Lift Column "Tappet Lift" to see this option.
- Added options to read different lobes in Cam Pro Plus files. It previously defaulted to just the first lobe, typically Cylinder #1.
- Added Edit Command to Copy or Swap Lobes option under File command.

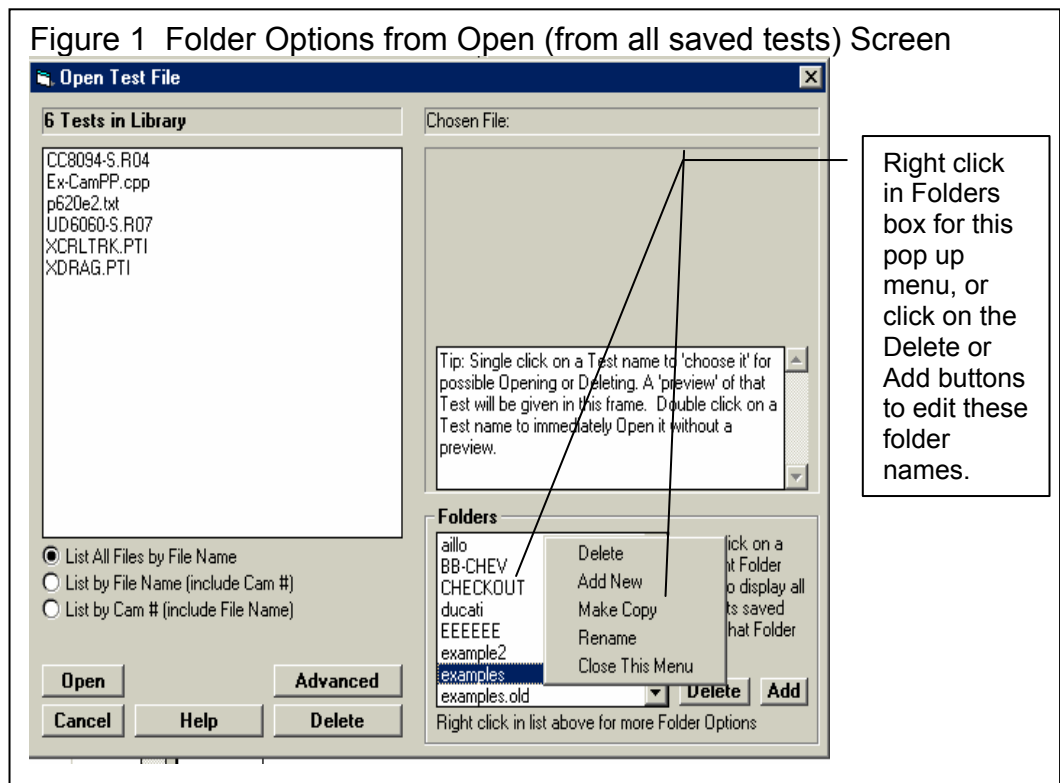

Some of these features will be illustrated below.

Figure 2 Exporting Cam Files in Comp Cams™ File Format

Click on File, then Create ...

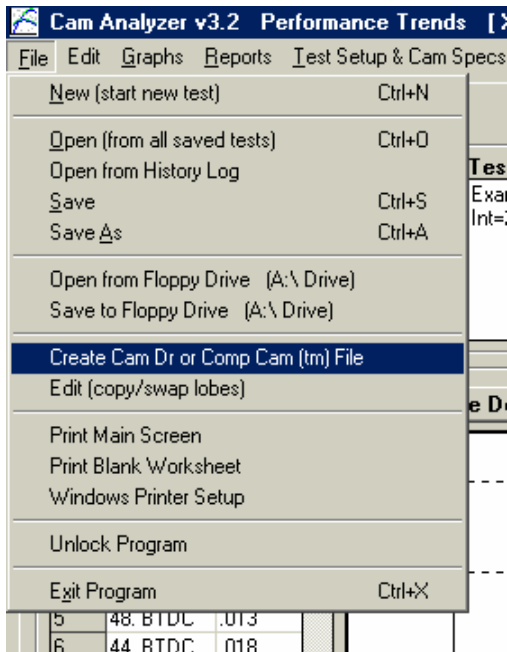

For this Cam Dr/Comp Cam Menu

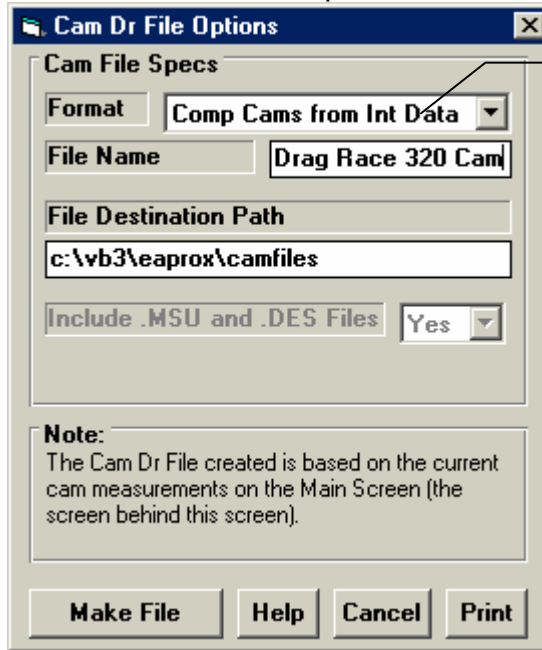

Select Comp Cams option for either exporting the Intake or Exhaust cam profile from the current cam profile on the Main Screen.

Figure 3 New Preferences

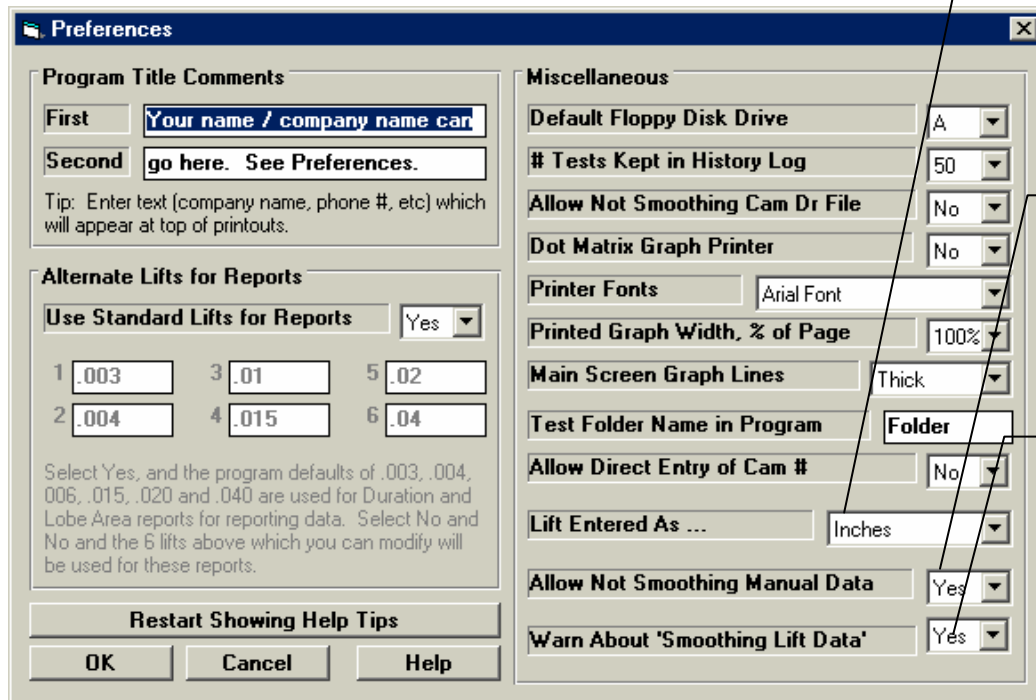

Lift can be entered either as inches or millimeters.

Select Yes here to show the "Smoothing" option in the Test Options screen. See Figure 4.

Here you can turn On or Off warnings which may appear when you close the Test Options menu about Smoothing hand measured Lift Data depending on the Deg Incs you have selected.

Figure 4 Two Important New Test Options

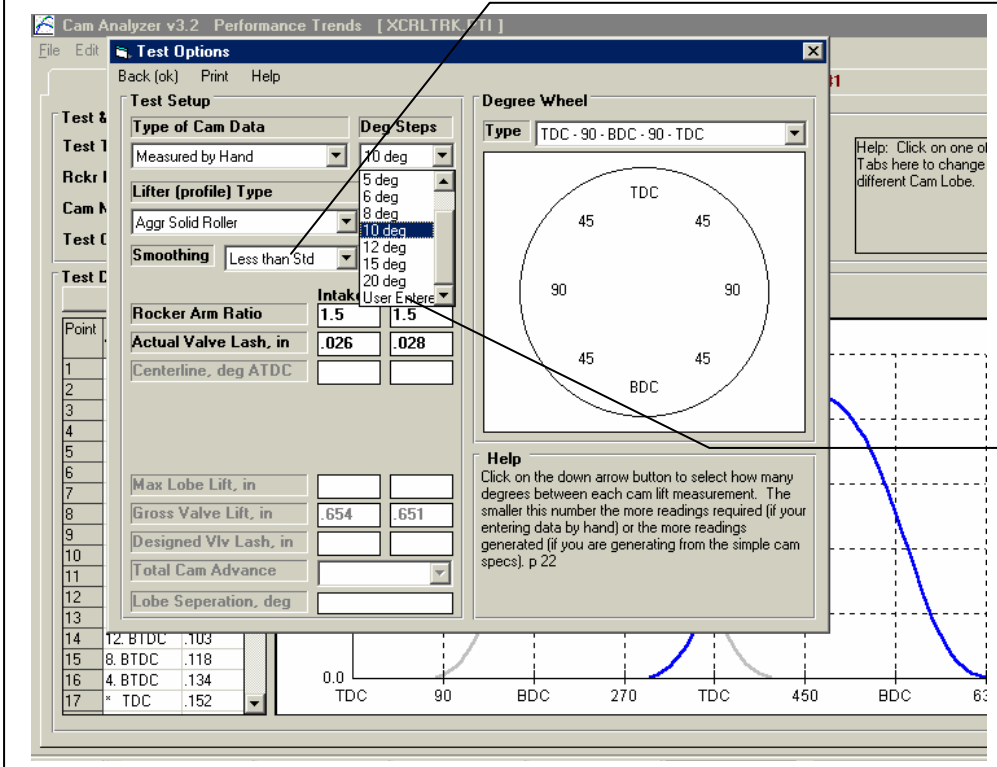

New Smoothing options for Cam Data which has been "Measured by Hand". If you are using large "Deg Steps" (larger than 6 degrees), it is recommended you use "Less than Std". There is usually NO reason to use "None" unless you want to compare the actual data measured with the "smoothed" data.

"User Entered" for Deg Steps let you enter the degree wheel reading at each reading. This way you can concentrate on areas of particular interest, say at peak lift and at the lower lifts, and record fewer points at other points to save time.

Figure 5 Edit Options, Including Converting Between Millimeters and Inches

The image shows the 'Edit' menu of Cam Analyzer v3.2. The menu items are: Copy or Swap Lobes, Add/Delete Rows of Data, Adv/Ret/Delete Deg Wheel Readings, Copy/Delete/Paste Tappet Lifts, Convert Lift Inches to Millimeters, Convert Lift Millimeters to Inches, Multiply Lift by a Factor, and Round Off Lift. Below the menu is a table with columns: Point, Degree Wheel, and Tappet Lift. The table contains data for '20. ATDC' and '002'. Three callout boxes point to the menu items: 'Click on Edit for these Edit options', 'Click on Copy or Swap Lobes for the Swap Lobes menu shown below.', and 'Click on the top of these 3 columns (Point, Degree Wheel or Tappet Lift) for the Edit Test Data options shown below to appear.'

Three dialog boxes are shown below the menu:

- Edit Test Data**: Contains buttons for 'Delete the Previous Rows', 'Delete the Remaining Rows', 'Cancel', 'Insert 1 Row', and 'Delete Row'. A note at the bottom explains the delete options.
- Edit Test Data**: Contains buttons for 'Erase Column', 'Advance', 'Retard', 'Cancel', and 'Cancel'. A note at the bottom explains the Advance and Retard buttons.
- Edit Test Data**: Contains buttons for 'Copy to Clipboard', 'Erase Column', 'Cancel', 'Paste from Clipboard', and 'Cancel'. A note at the bottom explains the Copy to Clipboard button.

The **Swap Lobes** dialog box is also shown, with fields for 'Edit Action' (set to Copy), 'Copy Which Lobe' (set to Intake to Exhaust), and 'Lobe Separation (cam deg)' (set to 105). A note at the bottom explains the feature.

Figure 6 Illustration of "Smoothing"

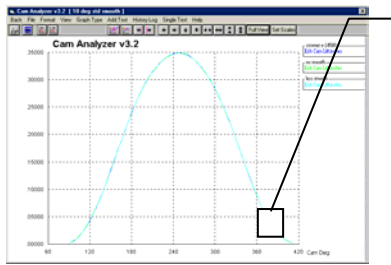

This graph is of 3 cam files Measured by Hand with 3 different smoothing settings, Standard, Less than Standard and None. See Figure 3. With mouse, click and drag to draw a box around the closing ramp to zoom in.

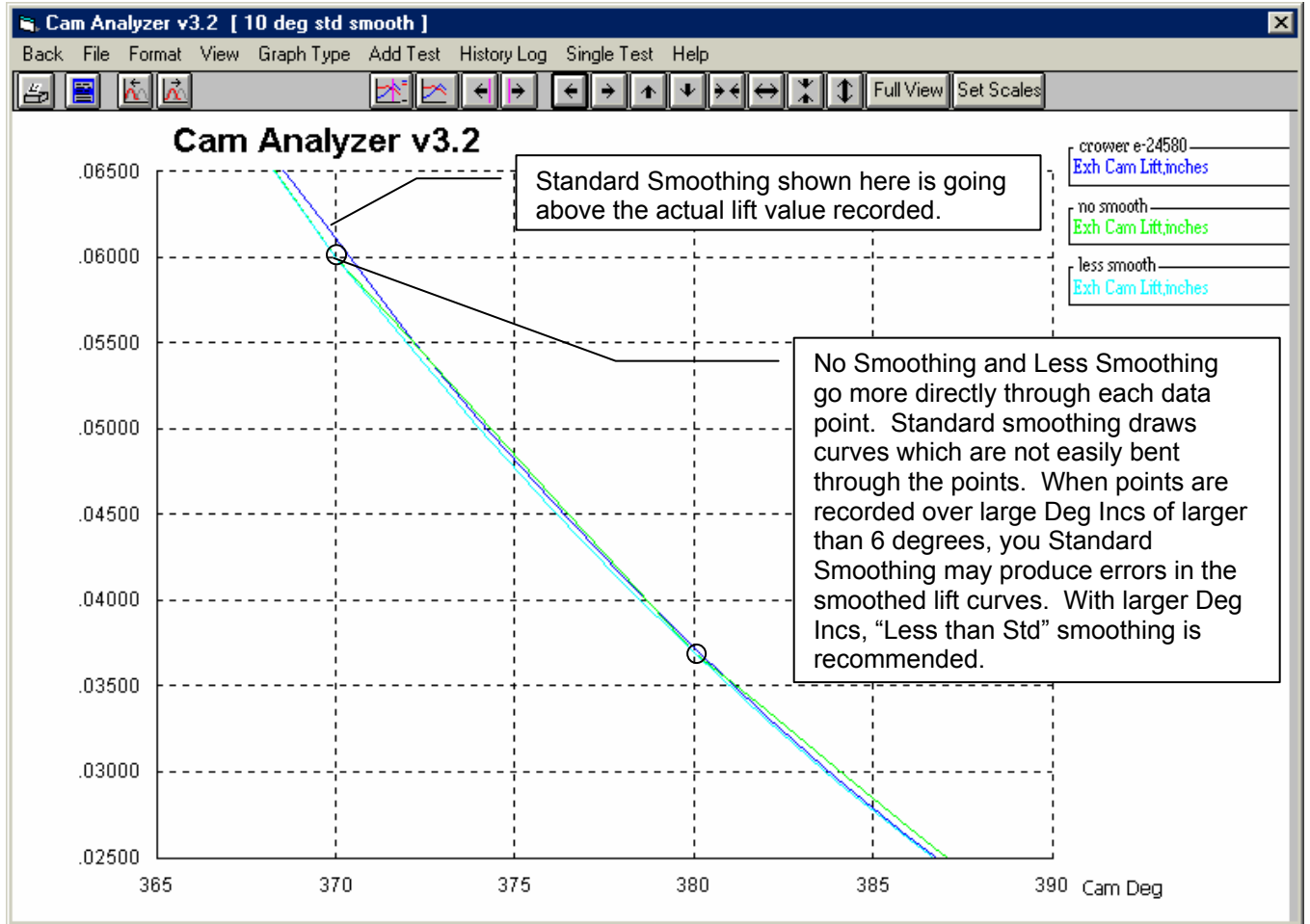

Acceleration with Standard Smoothing (relatively accurate)

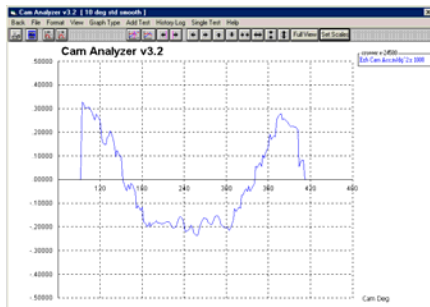

Acceleration with Less than Std Smoothing (jumpy data)

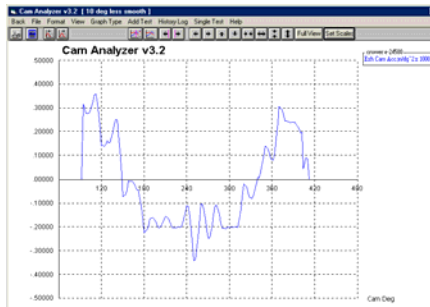

Acceleration with No Smoothing (very jumpy data)

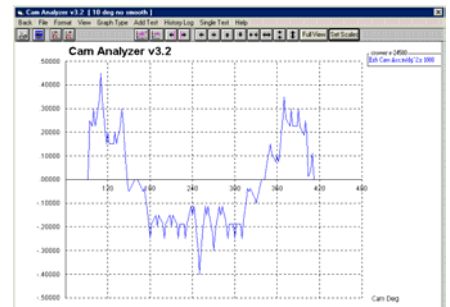

Tips on Smoothing

- No Smoothing draws straight lines directly through each data point. Even if each data point you record is exactly correct, this method of estimating the cam profile between points is not very accurate, because the cam profile is a curve, not segments of straight lines.
- Standard smoothing draws curves which are not easily bent through the points. This was the smoothing done to all cam profiles in version 2.0. Since the curves are not easily bent, it may not draw the cam profile exactly through each point you record. This can actually be more accurate because it is impossible to exactly measure each point. This method can also “flag out” errors in data entry when hand recorded points do not lie on smooth curves. However, if you are using large degree wheel increments for making measurements (something larger than 6 degrees), this method may be too “stiff” to bend accurately through the points you have recorded.
- Less than Standard Smoothing draws curves between points, but bends more easily than Standard Smoothing. This is the amount of smoothing recommended if you are using large degree wheel increments, something greater than 6 degrees.

Appendix 4: New Features for Cam Test Stand (v3.2 B)

Check Appendices 5 through 8 for several recently added features.

Several new features are included in v3.2 B. Most all these features involve using the electronics, encoders and test stand to measure camshafts quickly and accurately. Figure A4.1 shows the cam test stand and critical components.

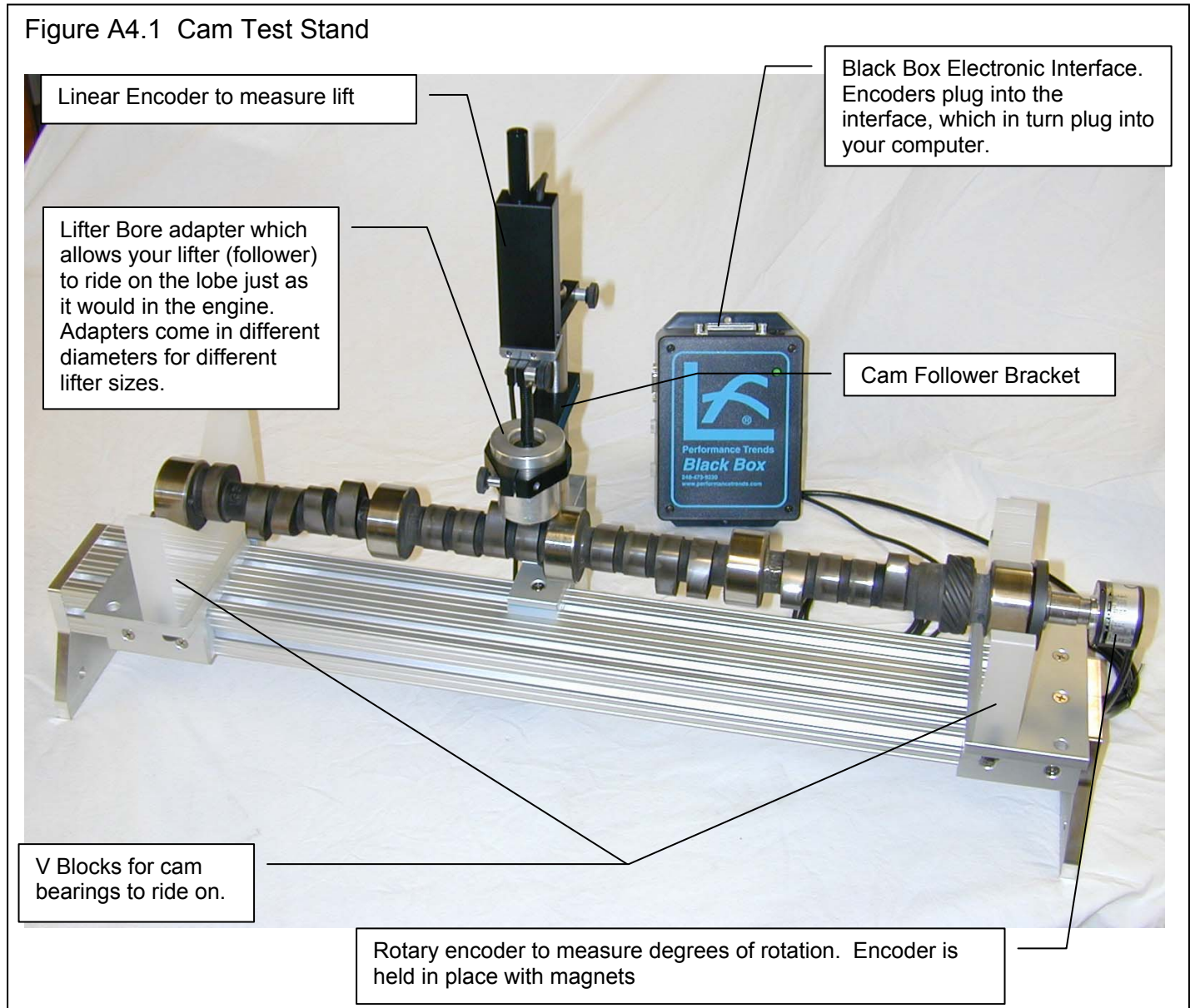

The first part of this supplement will be arranged as a series of steps to get your software and hardware setup so you can start measuring cams and analyzing the results. At the end of this supplement there will be sections discussing more new features.

A4.1 Setting Up and Running A Test

1 Set Up Black Box II

Make the connections as shown in Figure A4.2. You will need a USB-COM (serial) adapter if your computer does not have a true COM (serial) port.

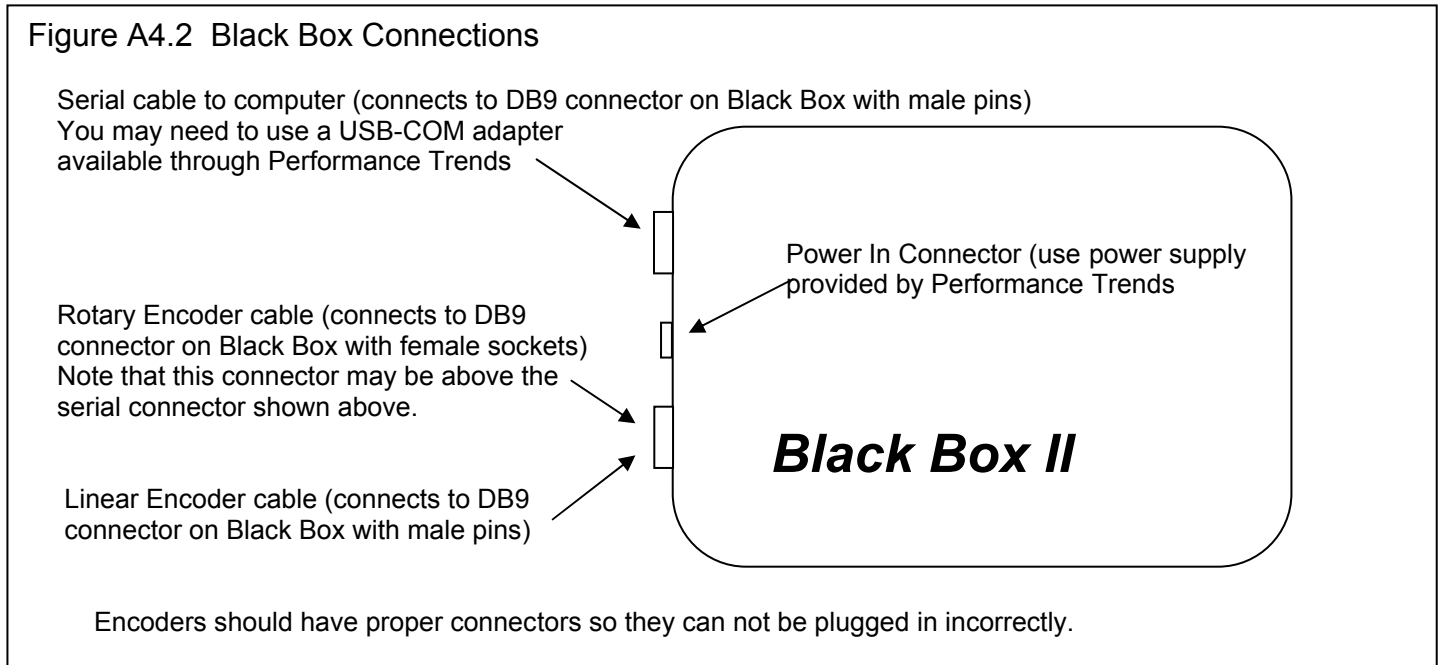

2 Set Up Software

It is easiest to start by opening up an example test which was done with the Cam Test Stand. This is shown in Figure 3. Click on File, then Open from All Saved Tests at the upper left corner of the main screen. Click on the SB Ford on Stand or SB Chevy on Stand from the Examples folder, then click on Open to open that test file. Back at the main screen you will see all 16 lobes with tabs across the top for each one in cylinder numbering order. At the bottom of the main screen you will see the lobes drawn out as they are arranged on the camshaft itself, including bearings, distributor gear (if any), etc.

You can click on the tabs at the top, or the numbers on the lobes on the bottom to move to that particular lobe. Then its data is listed in the spreadsheet in the lower left corner and its graph is shown on the graph section in color. If you have selected the appropriate preference, lobes for all other cylinders are also shown for comparison to let you spot lobes which are different from the rest. See Section A4.4 New Preferences.

You must tell the software what type of rotary encoder you are using. See Figure A4.4 This is done by clicking on Settings at the top of the main screen, then Tester Calibration, then typing in 2500 for Rotary Sensor Pulses/Rev. (Old Cam Dr encoders are 3600.) You can also set the Com Port you will use to connect to the Black Box, typically Com 1 on older computers. If you are not sure which com ports are available on your computer, click on the Find button and let the program try all com ports to see if it can find the Black Box. Be sure the Black Box is powered up (green LED lit) and the serial cable is connected correctly when doing this. This “Finding” process may take 30-60 seconds.

When you have set these items, click on Back at the top of the Cam Tester Specs screen, then choose to save these changes when asked by the program. These will then be saved as the “Master” Cam Tester Specs, which the program assumes is the encoder you are using right now. If you would open a previously done test, you may see different Cam Tester Specs. That is because those items were used for that test, which may not be the same as for the Cam Test Stand you are running right now.

Figure A4.3 Opening an Example Test Which Was Done on a Cam Test Stand

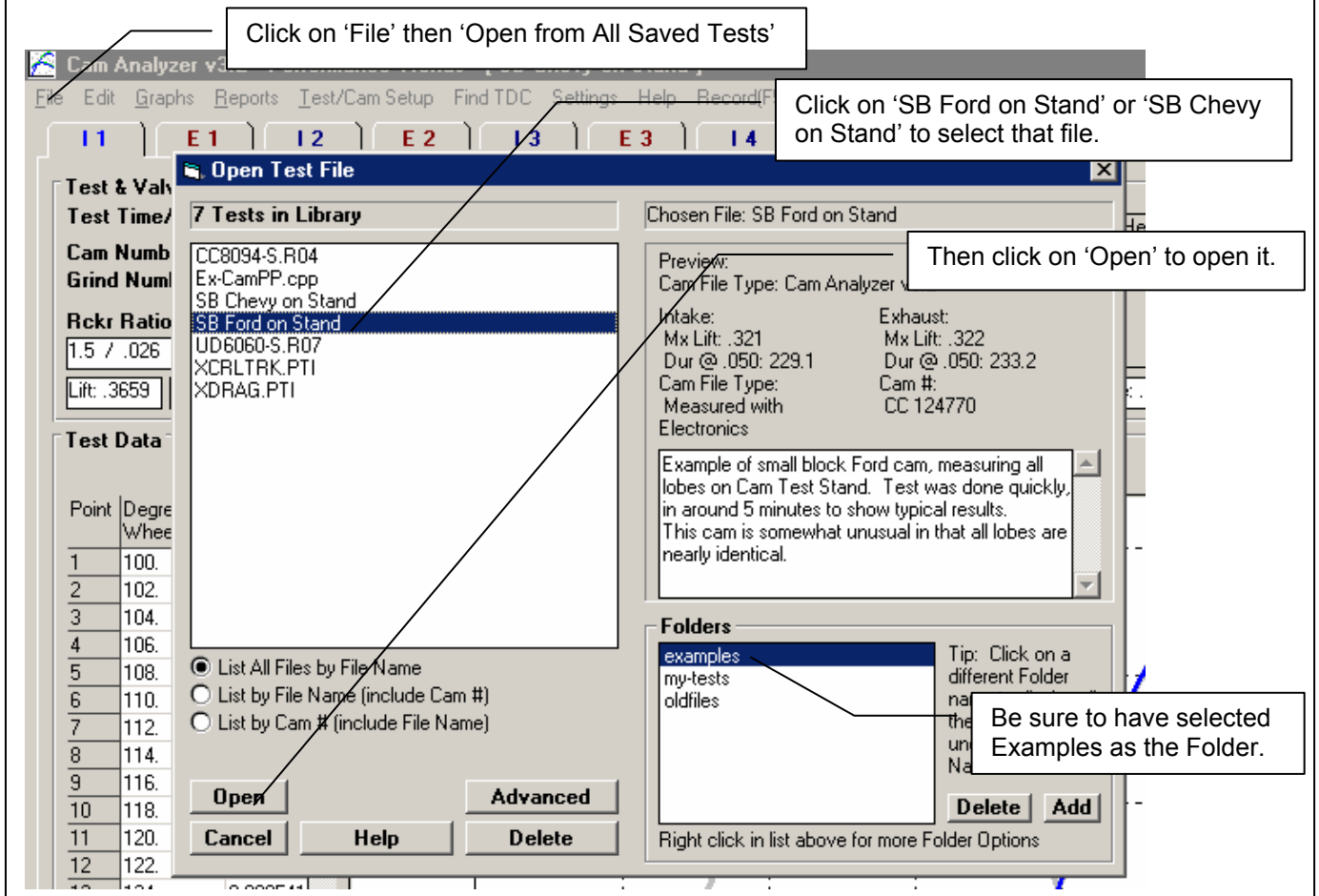
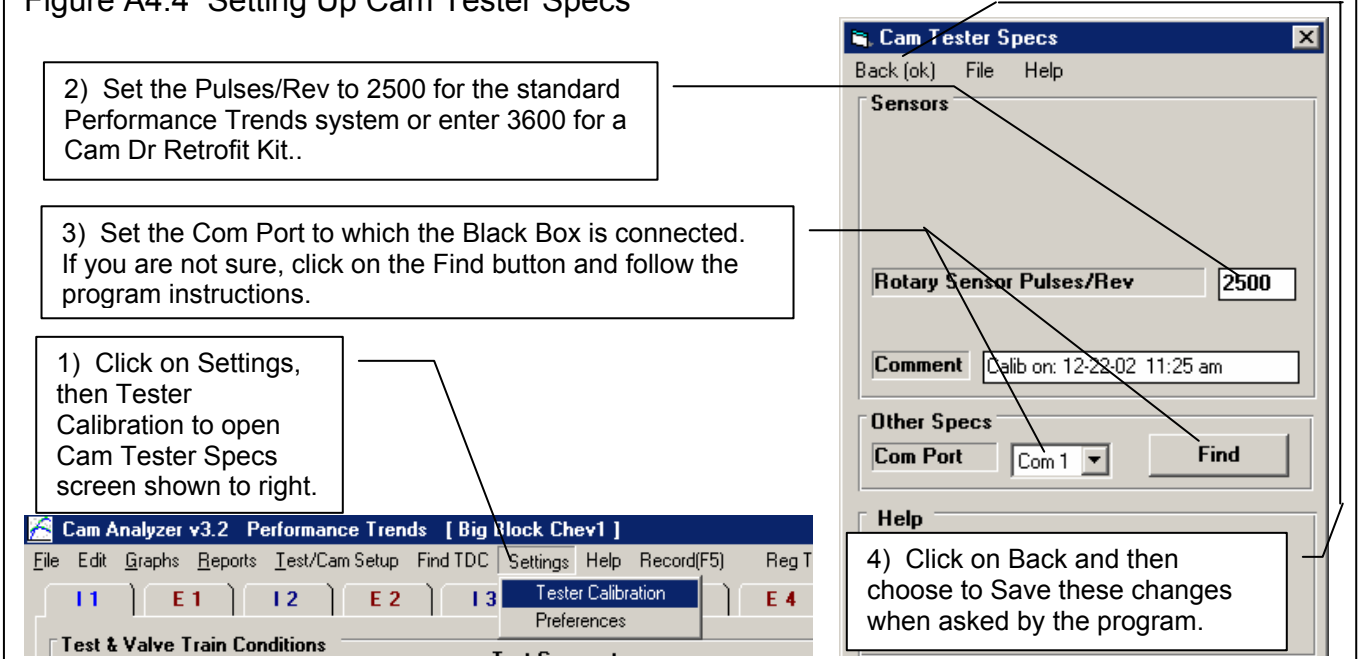

Figure A4.4 Setting Up Cam Tester Specs



3 Starting a New Test

To start a new test, click on 'File', then 'New (start new test)' at the upper left corner of the main screen. See Figure A4.5.

Figure A4.5 Starting a New Test

1) Click on 'File', then 'New (start new test)' to open this Starting a New Test

2) Be sure to check this box for "Using Electronics" to display the 'Specs for Electronics' section shown here.

3) Set these 'Specs for Electronics' for your cam to be tested. These are explained in this section of text.

4) If you are not sure of what to set the 'TDC Method' to, choose Intake Centerline and set the Cam Timing Value to something typical, like 110 deg.

5) Hopefully your Cam Design will already be available. If not, you will have to set up several specs in the Test Setup menu. Click on See Specs button to do this. These specs are covered in Section A4.2.

6) Check Section 2.6 in this User's Manual for more info on this New Test Screen. To display User's Manual when running the program, click on 'Help', then 'Display User's Manual' at top of the Main Screen.

7) When finished making your selections, click on Start New Test.

Specs for Electronics

- Cam Design
- TDC Method
- Cam Timing Value
- Number of Cyls to Test

The section 'Specs for Electronics' in the Starting a New Test screen contains critical items the software needs to know how your cam lobes are arranged on the camshaft. These critical items are covered in the upcoming Section A4.2.

For other inputs in this screen, check Section 2.6 in this manual. To Display this User's Manual when running the program, you can click on Help, then Display User's Manual at the top of the main screen.

When you have entered all the info and changes for this screen, click on ‘Start New Test’ at the upper left of this screen. You will be returned to the main screen with all lobes blanked out.

4) Running a Test

Figure A4.6 outlines the major steps to run a cam test. These steps will be discussed in more detail in the text of this section.

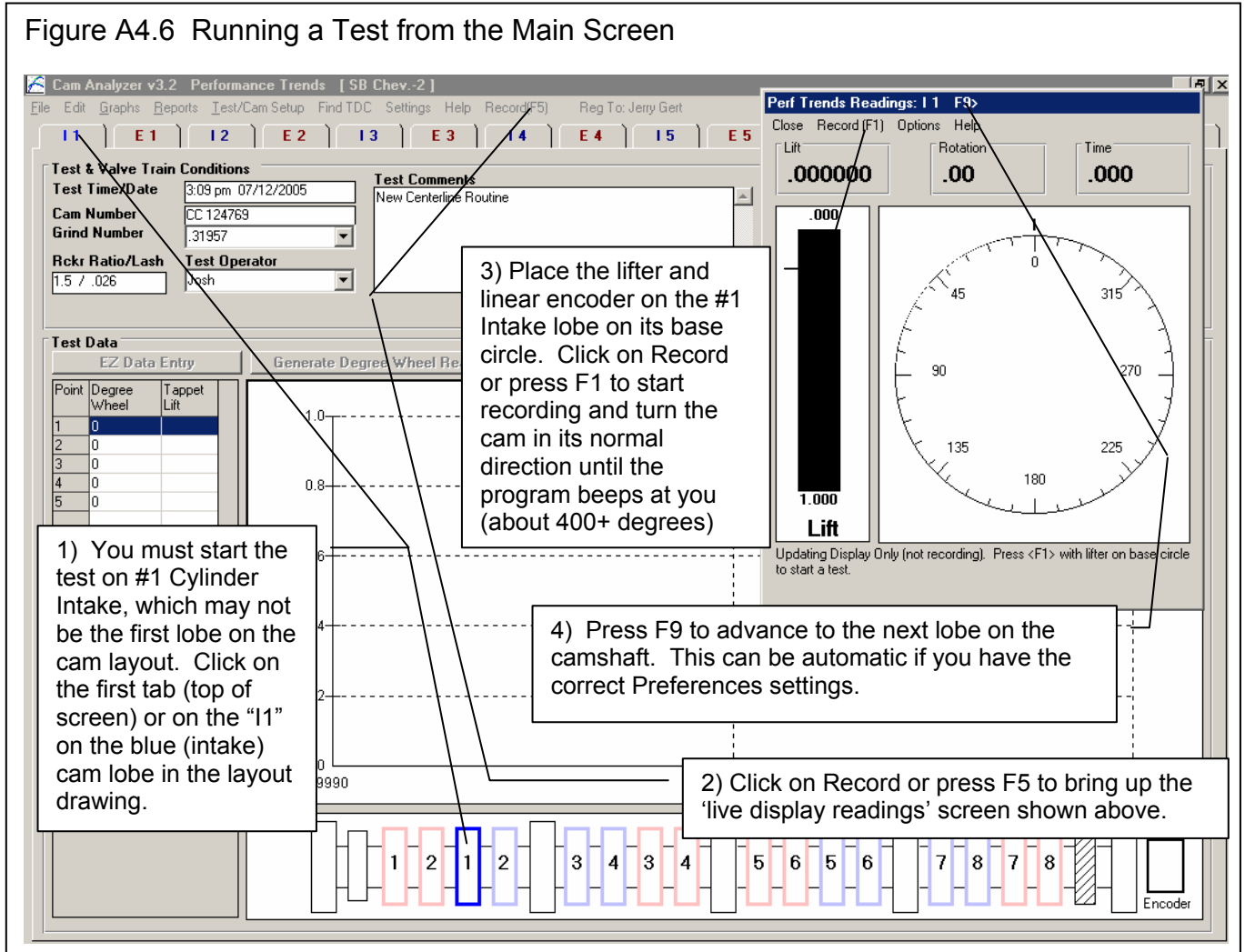

1) You must start the test on #1 Cylinder Intake, which may not be the first lobe on the cam layout. Click on the first blue tab at the top of screen or on the “I1” (for Intake #1) on the blue (intake) cam lobe in the layout drawing at the bottom of the screen.

2) Click on Record or press F5 to bring up the ‘live display readings’ screen shown above. When you first start talking to the Black Box, both encoders are zeroed out. This does not mean the measurement is zero. The true zero degrees will be determined after the #1 Intake lobe is measured, based on the timing method you have selected in the Starting a New Test screen. Zero lift is redetermined for each lobe based on the lowest reading read for that lobe (typically on the base circle).

If you get a message that the Black Box is not communicating, check some of the troubleshooting tips at the end of this document.

3) Place the lifter and linear encoder on the #1 Intake lobe on its base circle. See Figure A4.7. This is the part of the cam lobe on the opposite side from the ‘nose’ or peak. Click on Record or press F1 to start recording and turn the cam in its normal direction until the program beeps at you (about 400+ degrees). Turn the cam relatively slowly and smoothly. It should take at

least 10 seconds to rotate the cam. It is most critical to rotate the cam slowly when on the actual lobe. When on base circle, you can rotate the cam more quickly.

If you turn the cam in the wrong direction, it will beep at you. If this happens and you believe you are turning it in the correct direction, check that the Rotary Encoder is pictured on the correct end of the cam in the Cam Layout drawing. If that is correct, then you must have the Rotation Direction wrong in the Cam Layout specs, discussed in Section A4.2.3.

4) Press F9 to advance to the next lobe on the camshaft. This can be automatic if you have the correct Preferences settings. If you have turned other Preferences on, the program will make some checks to see that the lobe measurements appear accurate. Some of these checks have to do with turning the cam too fast. Others have to do with whether these results look the same as what was measured on #1 cylinder. Since this is #1 cylinder, this particular check is not done. If you are mostly interested in a quick check, these checks are not that important. If you want accurate acceleration and jerk details, you should use these checks to ‘flag out’ lobe measurements which could have errors. See Section A4.3 on New Preferences.

Loosen the Cam Follower Bracket, lift the follower up into its adapter, and slide the lifter and bracket to the next lobe as identified in the Cam Layout drawing by the highlighted lobe (brighter color than the rest). Lower the follower to the cam lobe and tighten the bracket. Then rotate the cam until the lifter is again on base circle (see Figure A4.7) and press F1 to start recording. Then rotate the cam slowly and smoothly until it beeps at you. The program will make it’s checks and then you or the program will advance it to the next lobe. Just keep repeating this pattern until all lobes are measured that you wanted to measure.

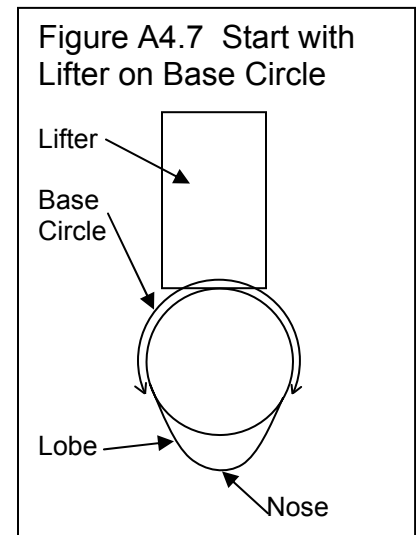

Tips:

The lifter must slide smoothly in the lifter bore adapter and the cam bearings must slide smoothly on the V blocks. CozmoLine (an ‘anti-rust’ coating) from new cams will be on the bearings and can get on the lifter itself and cause sticky, jerky (inaccurate) measurements. For quick checks of duration and lift this is OK if you are careful.

Be sure the pointed tip of the rotary encoder assembly is fully inserted into the pilot of the cam. If this is not done, you will see that the ring magnet will not be concentric on the cam’s end bearing, and the encoder will ‘orbit’ as you turn the cam.

Be sure the linear encoder’s tip is on a flat section of the lifter and not near the oil hole for the pushrod.

The slower you turn the cam, generally the more accurate the readings. You especially want to turn the cam slowly on the opening and closing ramps, where lift changes rapidly. We’ve measured lobes rotating them in anywhere from 5 seconds up to 30 seconds per lobe. Stopping the rotation to reposition your hand has generally not been a problem.

When you turn the cam, turn on a gear or bearing well away from the lobe being measured and close to one of the V block supports on the Cam Test Stand. This helps ensure you are not loading and bending the camshaft. Also, try to only put a torque (twist) on the cam, and no side or up/down loading.

Route the linear encoder’s cable away from the camshaft. Route the rotary encoder’s cable in the same direction as the Support Rod which sets on the magnet.

Avoid having the camshaft move longitudinally (along its length) because the Rotary Encoder Support Rod may change its rotary position slightly on the magnet which keeps the rotary encoder indexed correctly.

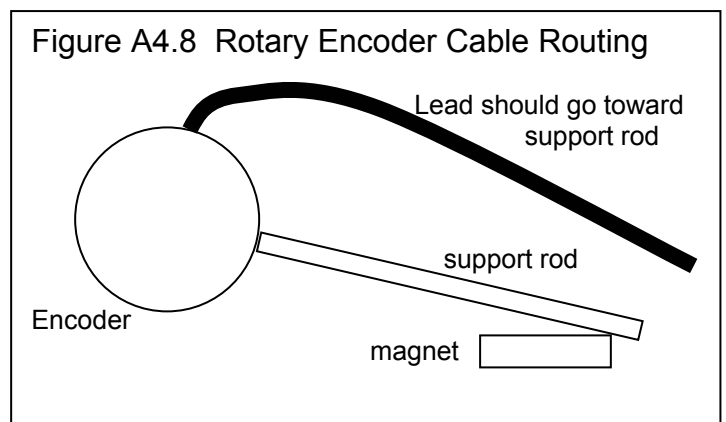

If you must restart measuring a cam you have already measured lobes on, you must first remeasure #1 Intake. This gets the rotary encoder and Black Box electronics indexed correctly. Then you can go directly to the next lobe in the sequence. (Note

that it is most accurate if you do *not* have to do this, but the amount of error introduced by this method is typically less than 0.2 degrees.)

5 Analyzing Data:

There are several new types of graph and report options that the v3.2 B provides. These are available by clicking on either Graph or Report at the top of the main screen as shown in Figure A4.9.

One of the most useful new reports is the Int & Exh Compare Specs, which lets you compare all lobes on the cam you tested. You can quickly see which lobes are significantly different than the others. Figure A4.9 shows you how you request the report on all Intake and Exhaust lobes. Figure A4.10 shows the resulting report.

Figure A4.9 New Analysis Features for Measurements Taken Electronically (with cam test stand)

Click on Graphs or Reports for new analysis features. Reports was clicked on here to show the Reports Options screen.

New Report options are available here. A very useful report type is "Int & Exh Compare Specs" to compare all lobes measured on the cam.

Details for each lobe are shown.

Tabular data is shown here for 400 crank degrees in 2 crank (1 cam degree) increments.

Choose which cylinders to include in the report, typically All as shown here. Other choices are possible by changing the "Cyls to Report" option.

Click here to make the report.

Point	Degree Wheel	Tappet Lift
1	100.	0.000689
2	102.	0.000630
3	104.	0.000630
4	106.	0.000630
5	108.	0.000630
6	110.	0.000630
7	112.	0.000620
8	114.	0.000591
9	116.	0.000605
10	118.	0.000551
11	120.	0.000551
12	122.	0.000556
13	124.	0.000541
14	126.	0.000527
15	128.	0.000515
16	130.	0.000464

Another new report type is Compare Measurement Comments. As discussed earlier, the program makes checks of the measurement data for each lobe measured. The results of these checks are saved so that you can check them if you want. See Figure A4.11. These checks include:

Max Gaps: You would have to turn the cam extremely slowly for the computer to get a measurement at each cam degree of rotation. Therefore, the program uses sophisticated math to fill in gaps in your measurements. If the gap to be

filled is too great, the results may have some errors. The Max Gaps comments display the largest gap in crankshaft degrees and largest gap in lift. These checks are only made for the actual lobe, and not on base circle, where measurements are not that critical. For example, if you see something unusual in a lobe, you can check these comments to see if there may be a reason for the unusual results and my decide to measure the lobe again.

Max Error: In the process of filling in the gaps, the program estimates the amount of *average* error estimating lobe lift for each gap. Although these errors look small, it must be remembered that the actual error could be much greater than the *average* error. Also, even small errors in lift can produce very large errors in acceleration and jerk calculations.

High Accels: The program checks each lobe to see if there are unusual looking “breaks” in the lift curve, like a sharp bump or dip. With a follower on the cam (not a small pointer), it is impossible for these to be seen even if they were there. Therefore, it can be assumed these are measurement errors. If these “breaks” are found, the words “High Accels” are added to the Measurement Comments.

Figure A4.9 also shows a new option for graphs and reports, in the Cylinders to Report section at the bottom of their screens. In this section, you see ‘Cyls to Report’, which can be set to All, or Cyl 1 Only, or Pick. If you choose Pick, then the “Picked Cyls” entry box becomes enabled. There you can type in a list of cylinder numbers, separated by commas for the cylinders you want included in the report. For example, you could enter:

1, 4, 5

And the program would then do the report on only cylinders 1, 4 and 5. This can be most useful for graphs, where space in the legend limits the number of graphs you can include on one graph. Figure A4.12 shows picking 3 cylinders for the current test for graphing.

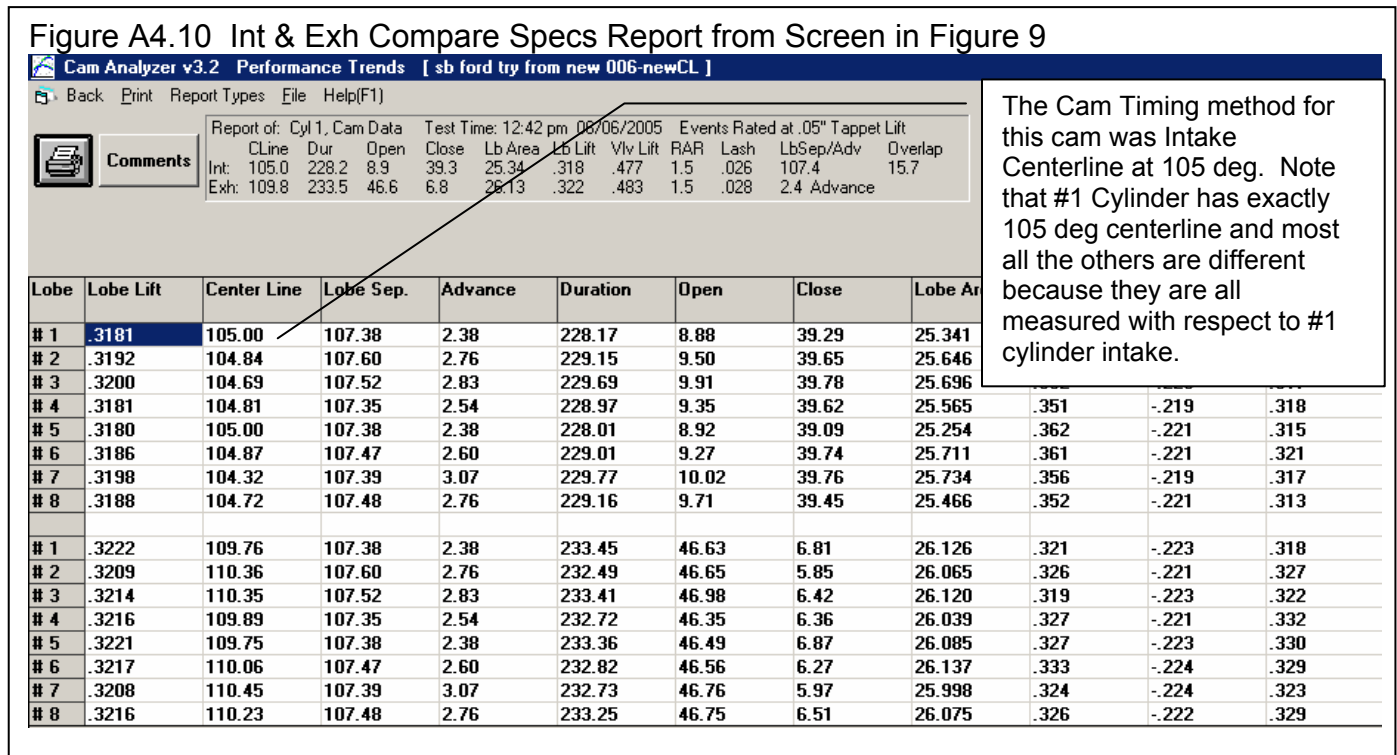

Figure A4.11 Compare Measurement Comments Report

Cam Analyzer v3.2 Performance Trends [sb chev]

Report of: Cyl 1, Cam Data Test Time: 11:33 am 06/08/2005 Events Rated at .05" Tappet

Int:	102.0	259.7	27.8	51.9	32.58	.366	.549	1.5	.026	105.5
Exh:	109.0	268.2	63.0	25.2	34.61	.382	.573	1.5	.028	3.5 Advance

Lobe	Comments
# 1	Max Gaps: Deg = 5.8 Lift = -.001 Max Er = .00011 @ .305 lift
# 2	Max Gaps: Deg = 4.8 Lift = -.002 Max Er = .00012 @ .132 lift
# 3	Max Gaps: Deg = 6.3 Lift = -.002 Max Er = .00011 @ .052 lift
# 4	Max Gaps: Deg = 5.0 Lift = -.001 Max Er = .00009 @ .125 lift
# 5	Max Gaps: Deg = 5.5 Lift = -.001 Max Er = .00009 @ .164 lift
# 6	Max Gaps: Deg = 6.8 Lift = .019 Max Er = .00011 @ .143 lift
# 7	Max Gaps: Deg = 7.4 Lift = -.001 Max Er = .00008 @ .065 lift
# 8	Max Gaps: Deg = 5.9 Lift = .016 Max Er = .00009 @ .277 lift
# 1	Max Gaps: Deg = 6.8 Lift = -.001 Max Er = .00010 @ .197 lift
# 2	Max Gaps: Deg = 8.4 Lift = -.002 Max Er = .00016 @ .251 lift
# 3	Max Gaps: Deg = 6.6 Lift = .018 Max Er = .00008 @ .245 lift
# 4	Max Gaps: Deg = 5.9 Lift = -.002 Max Er = .00012 @ .071 lift
# 5	Max Gaps: Deg = 5.3 Lift = .015 Max Er = .00011 @ .168 lift
# 6	Max Gaps: Deg = 4.9 Lift = -.001 Max Er = .00007 @ .069 lift
# 7	Max Gaps: Deg = 6.3 Lift = -.002 Max Er = .00019 @ .035 lift
# 8	Max Gaps: Deg = 5.9 Lift = -.002 Max Er = .00012 @ .128 lift

Figure A4.12 Picking Which Cylinders To Graph or Report

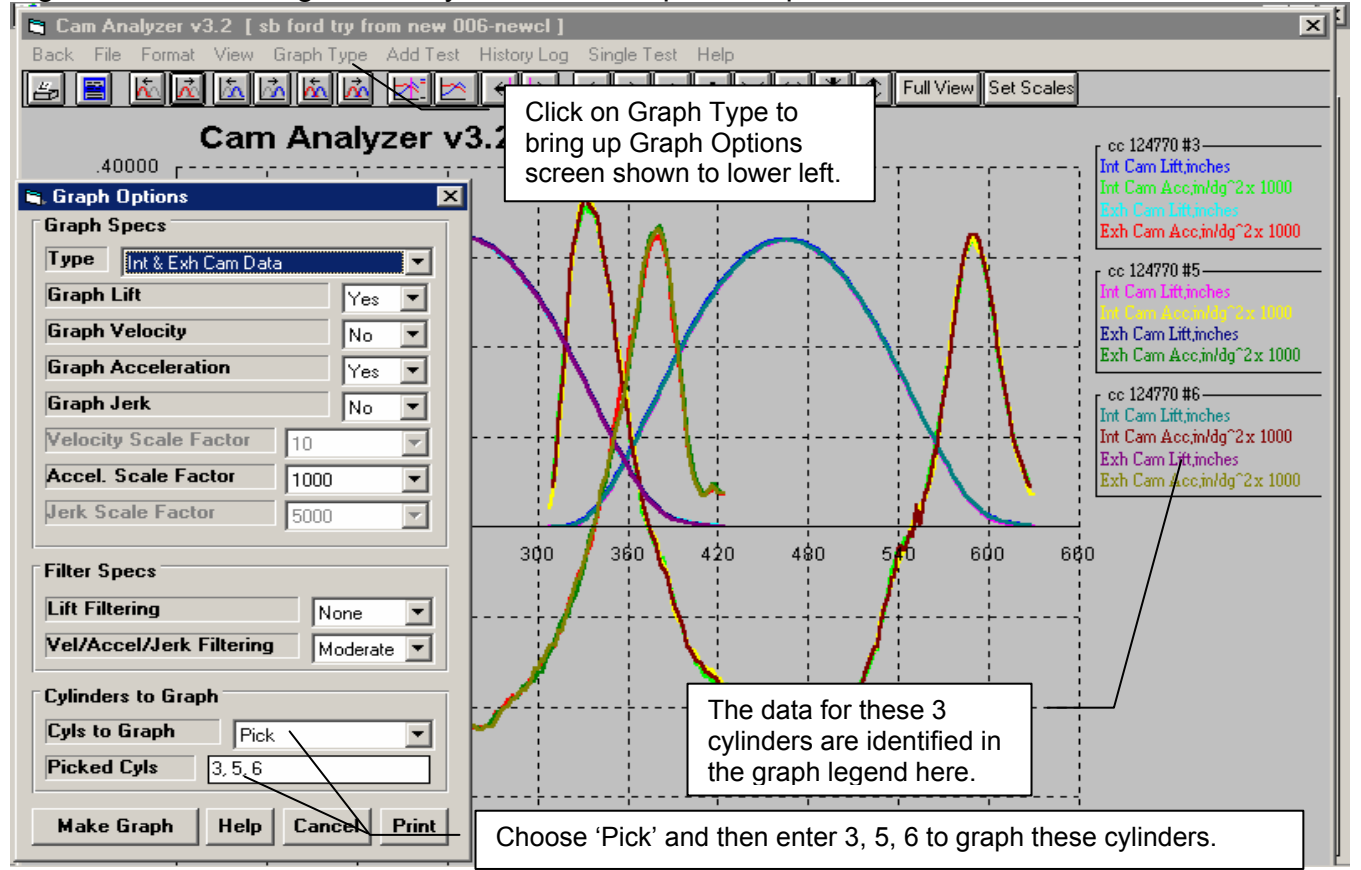

You can also specify which cylinders to include in a graph in the History Log. Figure A4.13 shows how you can pick different lobes from different cam test files for comparison graphs.

Figure A4.13 Picking Different Lobes from Different Cams

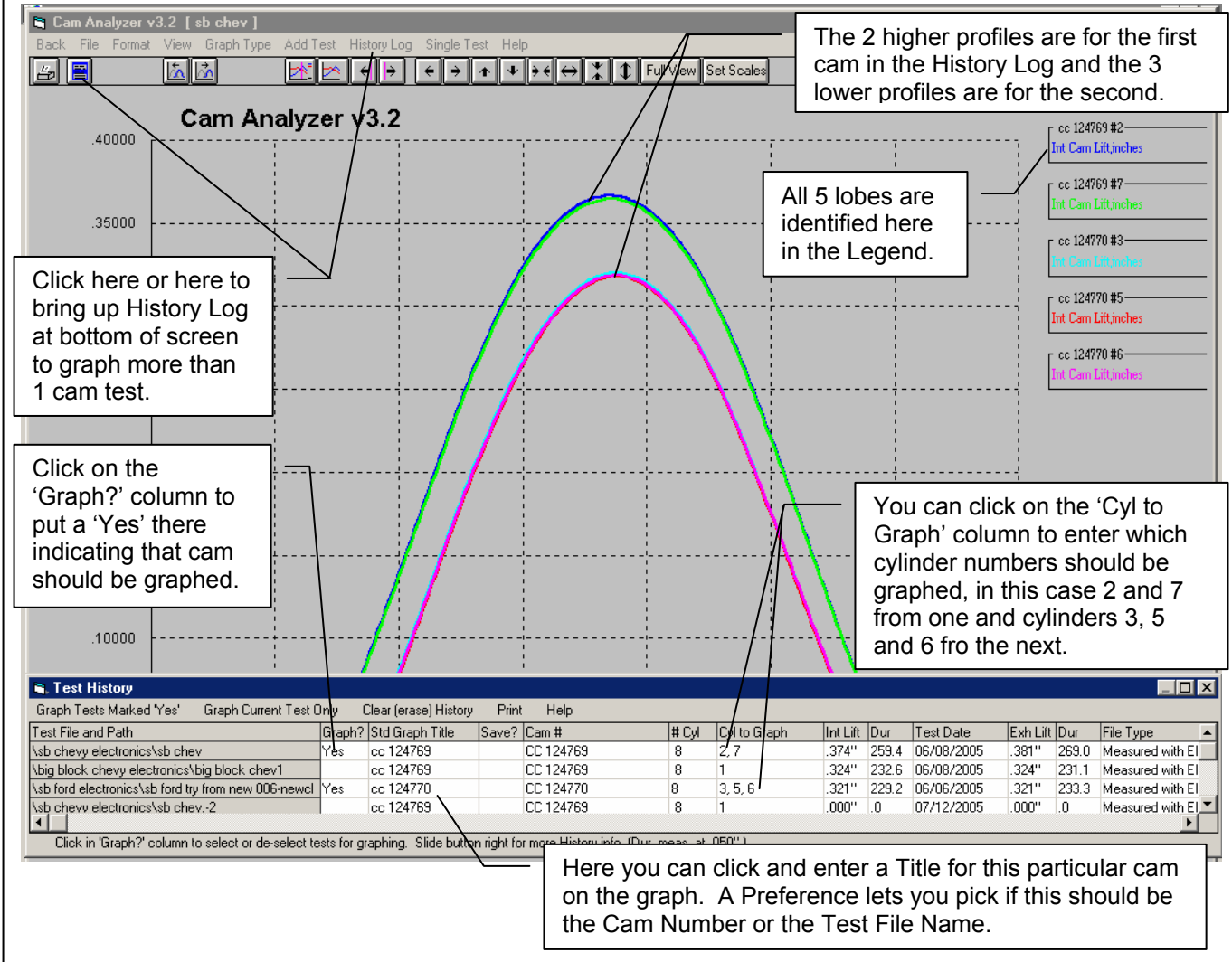

A4.2 New Test/Cam Setup Specs

If you had clicked on the See Specs for Test Setup specs in the Starting a New Test screen, you would be shown the screen in Figure A4.14. This screen is also available by clicking on Test/Cam Setup at the top of the Main Screen. In this screen are several important items concerning how the lobes are laid out on the camshaft, and how you want the cam data indexed to TDC.

When using the Cam Test Stand without the cam in the engine, there is no way to measure how the cam will be timed in the engine. It can only measure how the lobes are timed with respect to each other. When you select the TDC Method and Cam Timing Value, the program predicts all the cam timing values *assuming* you install the cam as the TDC Method and Cam Timing Value indicates.

Figure A4.14 Test/Cam Setup Specs

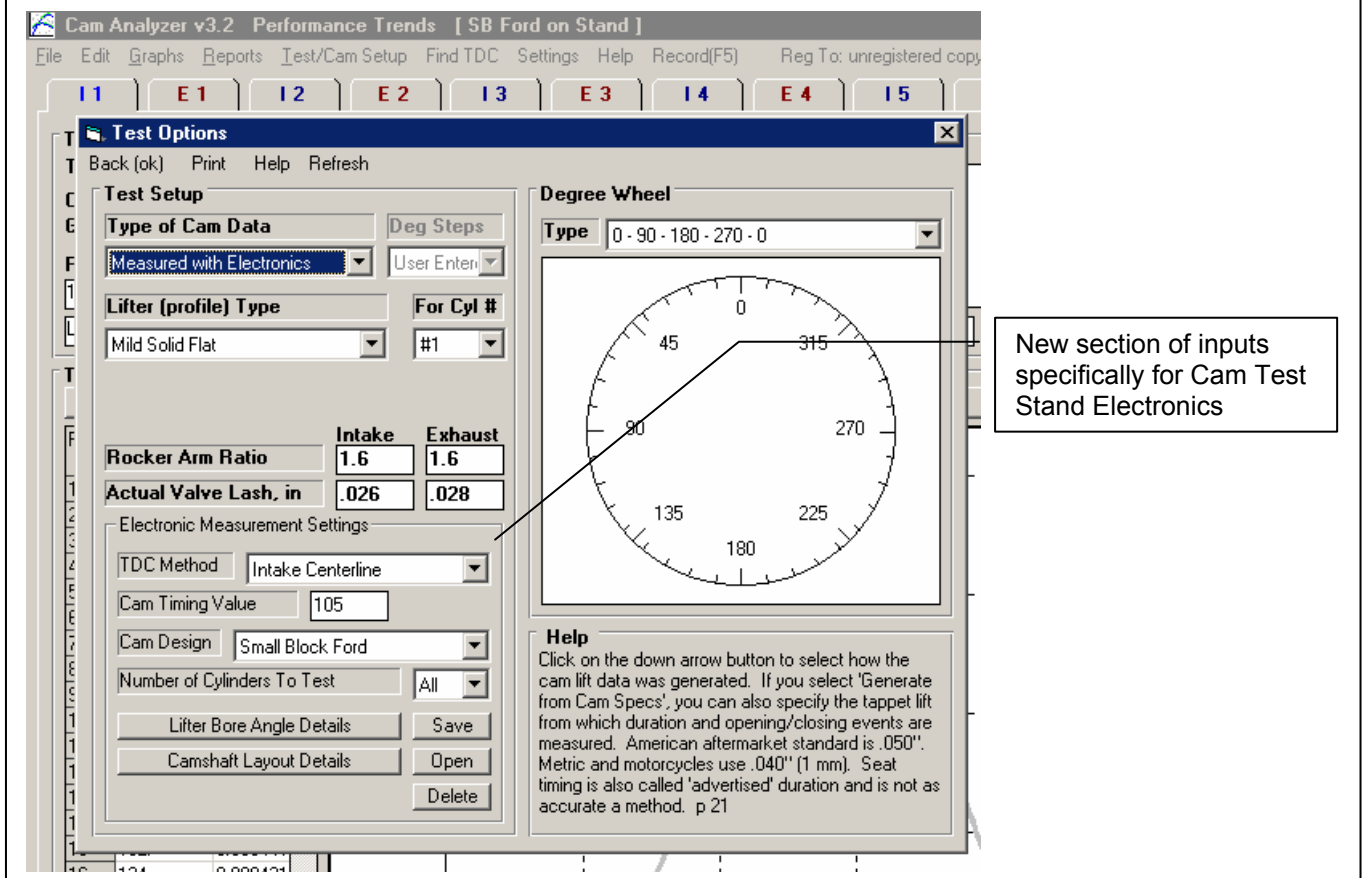

Type of Cam Data

When you choose 'Using Electronics' in the Starting a New Test screen, this spec is set to Measured with Electronics. You can also choose this in this screen after starting a test, but the program may not perform as expected. That is because this items is so critical to how the entire test is done. If this items is not set correctly, it is best to start a new test and be sure to choose 'Using Electronics' when you start the new test.

Lifter (profile) Type

The program uses your choice here only to know if the cam uses Hydraulic (no lash) or Solid (with lash) followers.

For Cyl

This will identify the cylinder number should you have selected to only measure 1 cylinder in the 'Electronic Measurement Settings' section for 'Number of Cylinders to Test'.

Rocker Arm Ratio Actual Valve Lash, in

These items let the program convert the measured lobe lift into valve lift for calculate results in reports and graphs. If you select one of the Hydraulic Lifter (profile) Types, the Actual Valve Lash inputs will be disabled.

A4.2.1 Electronics Measurement Settings

TDC Method Cam Timing Value

These two items work together to let you identify how this cam is timed in the engine. If your cam card gives you info on the cam's timing, you can enter these values directly. For example, if the cam card says the intake centerline is at 108 degrees, then choose Intake Centerline as the TDC Method and enter 108 as the Cam Timing Value. If the cam card says you should check the cam's intake lift at TDC in the engine, and it should be .145" lift, then choose Intake Lift at TDC as the TDC Method and enter .145 as the Cam Timing Value.

If you do not know how the cam is timed and have no cam card, then the recommended entries are Intake Centerline as the TDC Method and 110 as the Cam Timing Value.

When you measure a cam, the program will try to exactly put the intake lobe for Cylinder 1 at the exact timing you have specified here. (The intake lobe on Cylinder 1 is the first lobe which must be measured.) All other lobes will be timed as measured with respect to #1 Intake. (Note that the other intake lobes will probably not be exactly the same as #1 due to manufacturing tolerances.)

Cam Design

Here you can choose one of the preloaded cam designs provided by Performance Trends, or choose the top choice of Custom. If you use Custom, then you must click on the Lifter Bore Angle Details and Cam Layout Details buttons and enter all these items for your engine and cam. These items are discussed later in this section.

Cyls to Test

Here you can select to do all cylinders on the cam or just a smaller set. Typically you will only choose either All or just 1, where this would be for cylinder #1 only.

A4.2.2 Lifter Bore Angle Details

Lifter Bore Angle Details are NOT needed if you measure the cam in the engine. V 3.8 allows you to specify 'Measured in Engine' and ignore these details. Check Appendix 5.

Most engine builders do not worry about how the lobes are exactly laid out on the camshaft. But to the cam grinder, these angles are critical to getting each lobe timed exactly correct for each cylinder. Figure A4.15, diagram A shows lifter bores for a typical V-8 engine with normal clockwise rotation. All intake and exhaust lifters are at the same angle on the right bank and all are at a different, but equal angle different on the left bank.

For purposes of the Cam Analyzer, Lifter Bore Angles are measured with respect to #1 Cylinder Intake. If other lifter bore angles are the same as #1 Cylinder Intake, then you do not have to specify a Lifter Bore Angle for them. For most all V type engines, all cylinders on the other bank from #1 will have a different Lifter Bore Angle, which must be specified to the program. The left diagram A in Figure A4.15 shows a typical GM or Mopar V-8 engine, with #1 cylinder on the left bank and all lifter bores for the same bank exactly in line with each other. Diagram B shows one of the more complicated Lifter Bore Angle layouts you are likely to encounter, that for the Big Block Chevy. This engine has lifters at 4 different angles, 3 different angles with respect to #1 Intake. All these angles must be specified to the program and the cylinders and whether intake and/or exhaust lobes are involved. (Luckily, Performance Trends has loaded in several of these details for several engines, including the BB Chevy, and you can just pick a Cam Design and avoid these inputs.)

If you click on the Lifter Bore Angle Details button, you will be presented with the screens similar to those shown in Figure A4.16. These items identify the angle between the lifter bores for pushrod type engines. The angles on this screen describe how many *cam* degrees *before* #1 Cylinder Intake the other lobes are timed. These are the same angle that can be read from a blueprint of the engine.

Number of LBAs (Lifter Bore Angles) Needed

For most inline, pushrod engines, these inputs are not needed. You will specify 0 as the Number of LBAs needed and all other inputs are disabled. For V type engines, you are likely to need at least 1 LBA (like shown in Figure 4.15 diagram A) and possibly up to 3 (as shown in Figure 4.15 B).

Lifter Bore Angle #1

This is the number of degrees other cylinders' lifter bore angle comes *before* #1 Cylinder Intake's lifter bore. For example, in Figure 4.15 diagram A, because of the rotation direction, the right bank comes approximately 90 degrees before #1 cylinder. DO NOT assume that V engines have a lifter bore angle of 90 degrees or the same angle as the angle between cylinder bores. Most often they do not. You must check with the engine builder to know what the lifter bore angles are exactly.

Notice in Figure A4.16 that for the Small Block Ford (and most Fords) that #1 cylinder is on the right bank and the cylinders on the left bank come *after* #1 cylinder. For the Ford, the LBA is specified as a *negative* number because the other bank's cylinders come *after* #1 cylinder.

Cylinders Using LBA 1

Here you will enter a string of number separated by minus signs or dashes (-) for each cylinder number which will use this lifter bore angle.

Int or Exh

Here you specify if just the Intake lobes, just the Exhaust lobes, or both the Intake and Exhaust lobes will use this LBA.

Example for Filling In Specs for Big Block Chevy

The LBAs for the BB Chevy are 77.5 degrees between intake lifter bores and 90 degrees between exhaust lifter bores. That means the right bank's intakes occur 77.5 deg before the #1 intake. The #1 exhaust (and other exhausts on the left bank) occur $(90-77.5) / 2 = 6.25$ deg degrees after the #1 Intake (-6.25 deg). The right bank's exhausts occur 77.5 deg +6.25 deg before #1 intake. Using this info you will fill in the Lifter Bore Angle Details screen as shown in Figure A4.16 for the Big Block Chevy. (As stated earlier, Performance Trends has loaded in several of these details for several engines, including the BB Chevy, and you can just pick a Cam Design and avoid these inputs.)

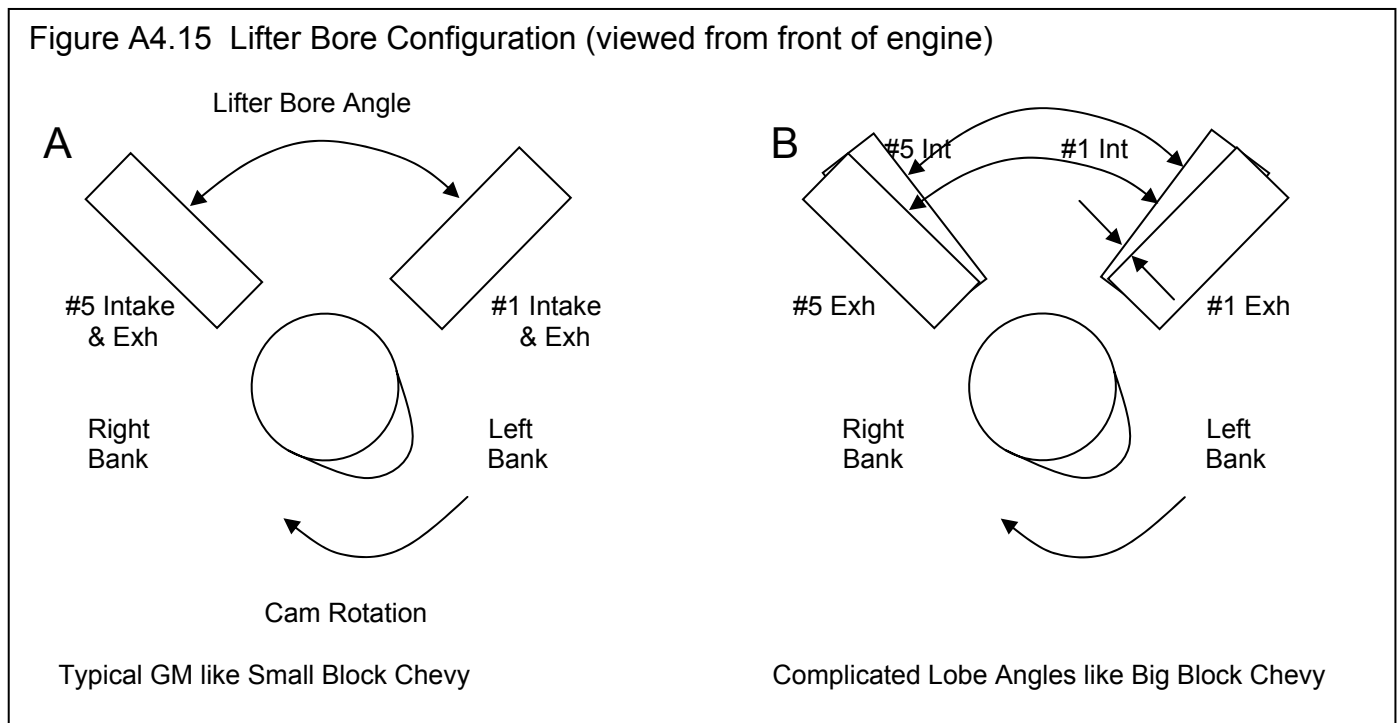

Figure A4.16 Some Typical Lifter Bore Angle Details Screens

The figure displays three instances of the 'Lifter Bore Angles' dialog box, each with a callout box explaining its configuration.

- Left Dialog:** 'Number of LBAs Needed' is 0. Callout: 'Setting for Typical Inline or OHC or Inline Engine'.
- Middle Dialog:** 'Number of LBAs Needed' is 1, 'Lifter Bore Angle #1' is -83, and 'Cylinders Using LBA 1' is 5-6-7-8. Callout: 'Settings for Small Block Ford (289, 302, etc)'. A note box states: 'Note that the Ford has a negative LBA for the other cylinders because #1 is on the left bank. The cylinders on the right bank come AFTER #1 cyl.'
- Right Dialog:** 'Number of LBAs Needed' is 3. 'Lifter Bore Angle #1' is 77.5, 'Cylinders Using LBA 1' is 2-4-6-8, 'Lifter Bore Angle #2' is 83.75, 'Cylinders Using LBA #2' is 2-4-6-8, 'Lifter Bore Angle #3' is -6.25, and 'Cylinders Using LBA #3' is 1-3-5-7. Callout: 'Complicated settings for Big Block Chevy, which has 3 lifter bore angles that are different than #1 Intake.' A note box states: 'Choose however many LBAs you need to describe the cam and the appropriate number of items will be enabled.'

Each dialog box includes a 'Notes' section at the bottom and buttons for 'Keep Settings', 'Help', 'Cancel', and 'Print'.

A4.2.3 Cam Layout Details

This screen contains other details about the cam in addition to the Lifter Bore Angle details, like firing order, how the lobes are organized on the cam, etc.

Cam Layout Details have been expanded in v3.8. Check Appendix 5.

Number Cylinders on Cam

Choose the number of cylinders for lobes on this cam.

Type of Lobes

Choose whether the cam has both Intake and Exhaust lobes, or just All Intake or All Exhaust lobes like those found in dual OHC engines.

Number of Intake Lobes

Choose the number of intake lobes *for each cylinder* on this cam. For all 2 valves per cylinder engines, this is 1. For, 3, 4 or 5 valves per cylinder engines, this could 2 or 3.

Number of Exhaust Lobes

Choose the number of exhaust lobes *for each cylinder* on this cam. For all 2 valves per cylinder engines, this is 1. For, 3, 4 or 5 valves per cylinder engines, this could 2 or 3.

Firing Order

Here you will enter a string of number separated by minus signs or dashes (-) for the firing order of the engine. You must start with cylinder #1.

Offset ('odd') Firing

Choose 'Yes' if you have an odd or uneven firing engine. The most notable odd fire engines are the Buick 'Odd Fire' V-6 and the Harley Davidson V twin. For most engines, you will choose 'No'.

Cyls. Offset from #1

If you chose 'Yes' for Offset Fireing above, you will enter a string of number separated by minus signs or dashes (-) for the cylinders which are different from cylinder #1.

Figure A4.17 Cam Layout Details Screen

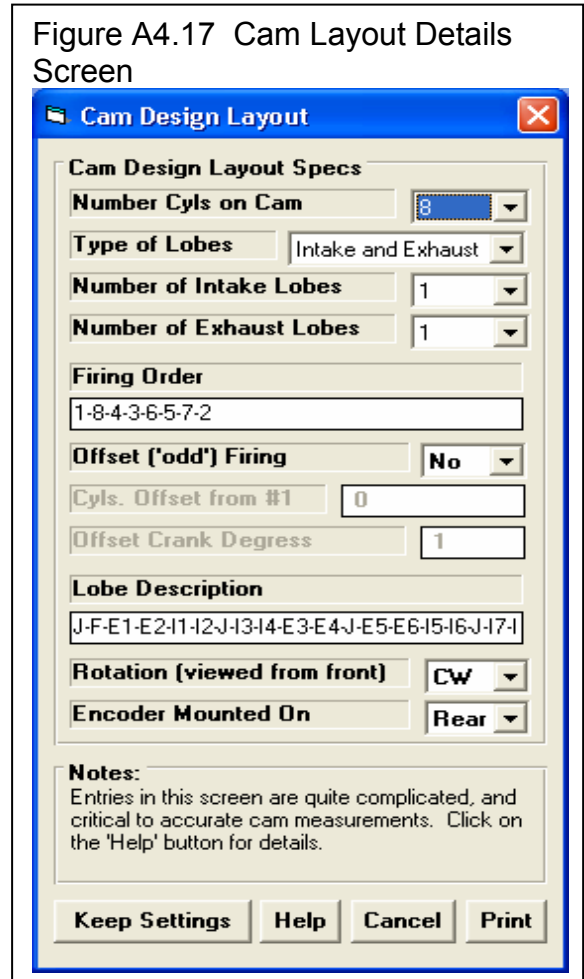

Offset Crank Degrees

Enter the number of degrees which the 'Cyls, Offset from #1' fire *before* they should if the engine was even firing.

Lobe Description

Here you will enter a string of numbers and letters separated by minus signs or dashes (-) for each lobe, bearing journal, fuel pump eccentric and distributor gear on the cam. Possible entries include:

- Ix * where x is a cylinder number. The 'I' indicates an intake lobe.
- Ex * where x is a cylinder number. The 'e' indicates an exhaust lobe.
- J A cam bearing journal (This was "B" in some earlier versions.)
- G A distributor (or other) gear
- F A fuel pump eccentric

* If there are more than 1 intake or exhaust valve per cylinder, include an A, B or C immediately after the cylinder number. For example, I2A is the first (A) Intake (I) lobe for cylinder number 2 (2). E4C is the third (C) Exhaust (E) lobe for cylinder number 4 (4).

This info is used to draw the Cam Layout on the main screen and to identify the lobes for graphing and making reports. This input can be tedious to enter, but is critical for identifying which lobes are which.

Rotation (viewed from front)

Here you choose whether the cam turns CW or CCW when viewed from the front of the engine. Most all non-marine engines turn CW.

Encoder Mounted On

Here you tell the program if the encoder is mounted on the front or rear of the camshaft. The encoder is then drawn in this position in the Cam Layout on the Main Screen. It also lets the program know how the encoder's readings should be coming into the program if you are turning the cam in the correct location.

A4.3 New Preferences

Several new Preferences have been added to let you customize how the program works with the electronics. See Figure A4.17.

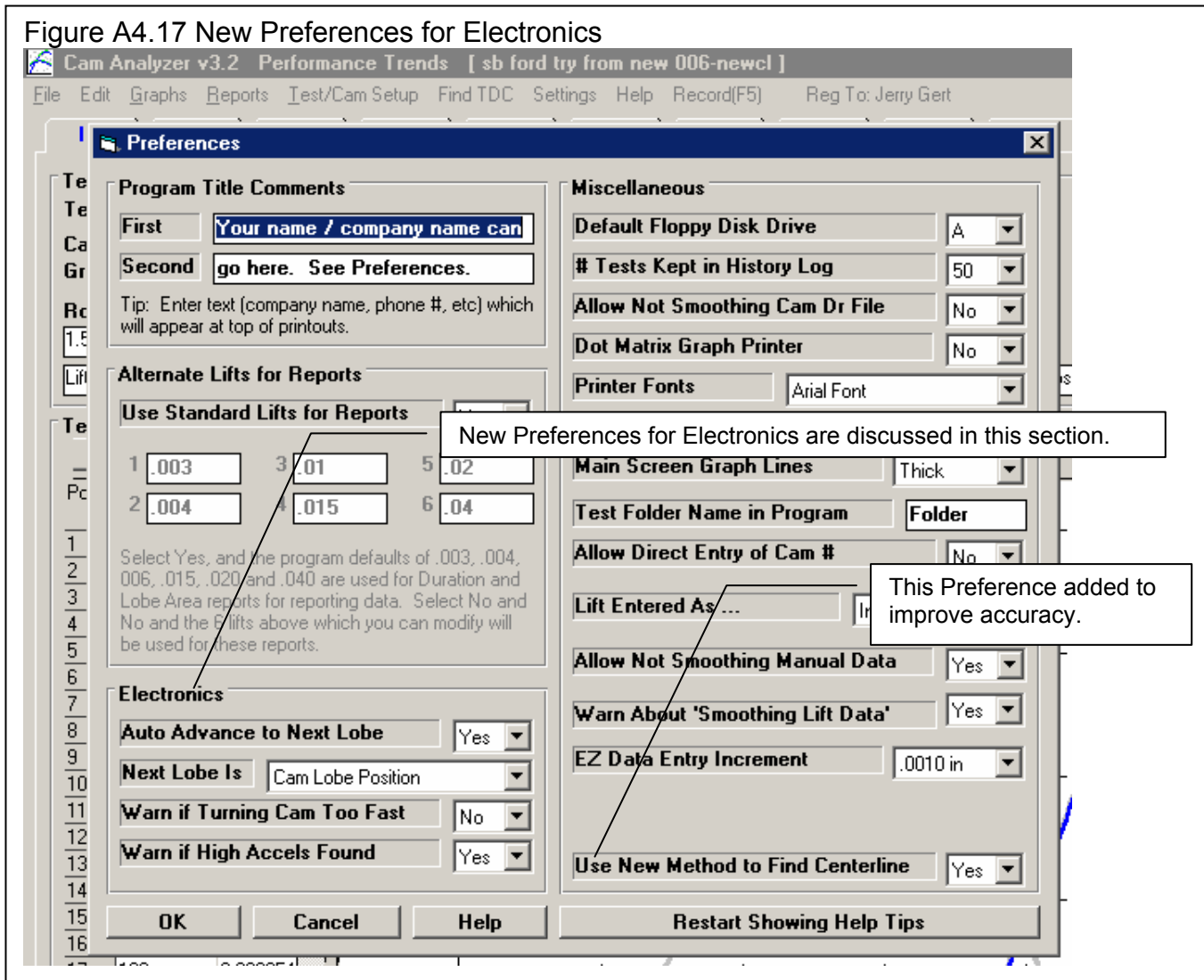

Auto Advance to Next Lobe

Select Yes and the program will automatically go (advance) to the next lobe on the camshaft after measuring a lobe. To which lobe is identified in the next Preference, "Next Lobe Is".

Next Lobe Is

If you selected Yes for Auto Advance above, this setting lets you select if you want the "next lobe" to be either the next lobe down the camshaft (as pictured in the Cam Layout drawing) or the next cylinder number (as identified on the tabs across the top of the main screen). Most users will select "Cam Lobe Position" on the actual camshaft.

Warn if Turning Cam Too Fast

After you measure a cam, the program checks if the “gaps” between measurement points are larger than what should be used for good accuracy. If the gap is large, the program will give you a warning message, where you can select to either continue to the next lobe, or redo the lobe just measured. If you want to be as precise as possible, set this to Yes. If you just want to quickly check a cam for duration, lobe separation and lift, then set this to No.

Warn if High Accels Found

After you measure a cam, the program checks if there a “bumps” or “dips” in the lift data which are not likely to be accurate. If they are found, the program will give you a warning message, where you can select to either continue to the next lobe, or redo the lobe just measured. If you want to be as precise as possible, set this to Yes. If you just want to quickly check a cam for duration, lobe separation and lift, then set this to No.

Use New Method to Find Centerline

Once we were using electronics to measure the cam lobes, we found that the method we were using to determine centerline was not as accurate or repeatable as it could be. We were using several points at near peak lift to determine centerline. Now we go much farther down the opening and closing profile to determine the lobe centerline. This has proven to be much more repeatable, within .1 degrees or better. The old method was repeatable within .5 degrees or so, which was sufficient for the hand measurements we used to do. We recommend setting this to Yes. No should only be used if you want to repeat results from an older version of Cam Analyzer.

A4.4 Troubleshooting Communications to Electronics

If you find that the program can not communicate with the Black Box, you may first want to let the program try to “Find” it as shown in Figure A4.4. If it can not be found, check the Troubleshooting features built into the Cam Analyzer in Figure A4.17. The first test available of “Test Com Port” is a very easy test to pass. That means if you can not pass it, there is a definite problem with the computer’s Com port, or the cable, or you are doing the test wrong. If the problem proves to be with the computer (which is usually does), then you must contact your computer repair shop. You could also switch to a USB to Com port converter if you have a USB port. (USB-Com port converters are typically not as reliable as a true Com port.) The “Check Boot Message” is a more thorough test, and checks both the Com port and cable, and some basic functioning of the Black Box.

Figure A4.18 Troubleshooting Options

Click on Help at top of Main Screen, then Troubleshooting, then pick from these 2 options.

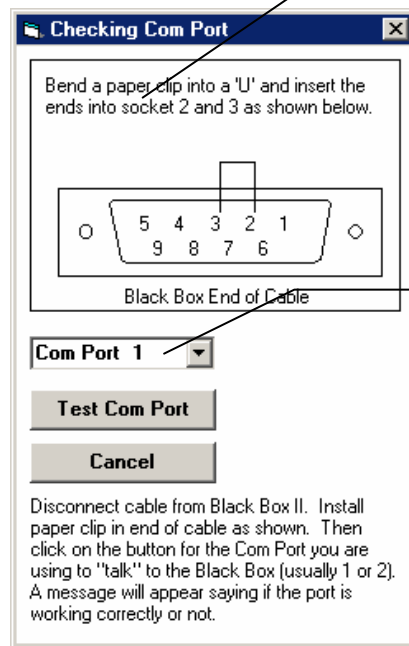
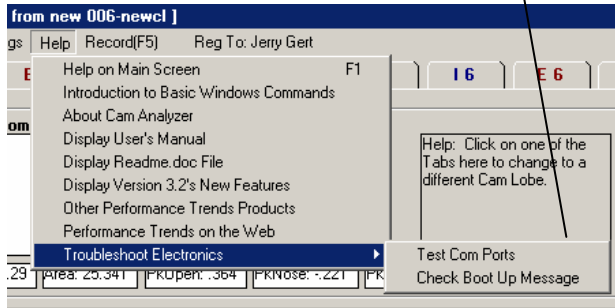

Follow instructions here and down below to run the 'paper clip' test to see if the com port is working at all.

Insert paper clip or piece of wire from pins 2 and 3. Then pick which port to test and click on the Test Com Port button and see if program says port is working.

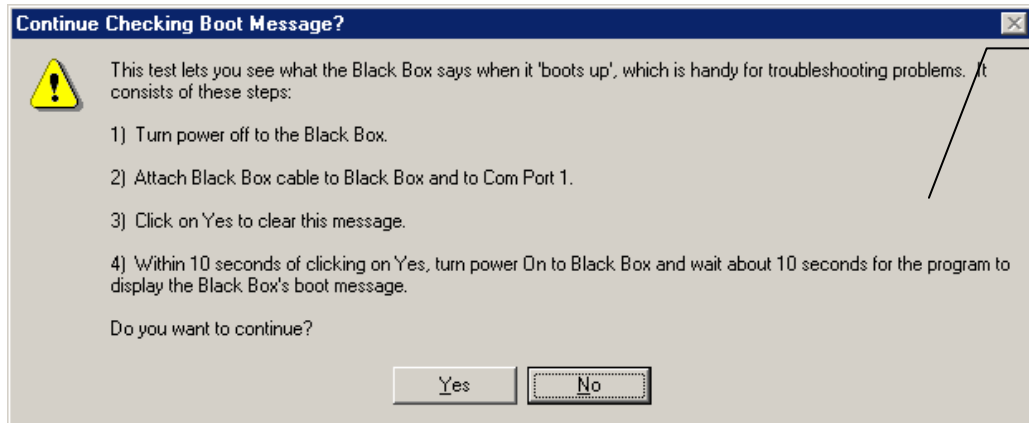

Instructions for running the "Boot Up Message" test, to see if the com port can read data from the Black Box II. This does not test if the computer can send data or the Black Box can read the data sent to it.

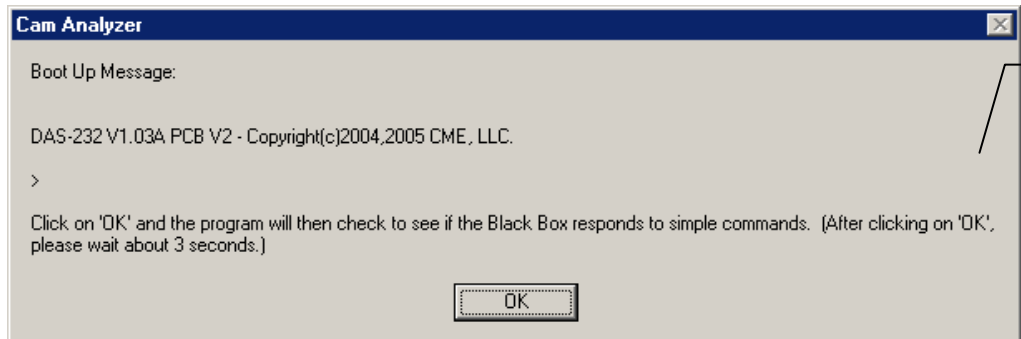

Typical response if the Boot Up Message can be read correctly.

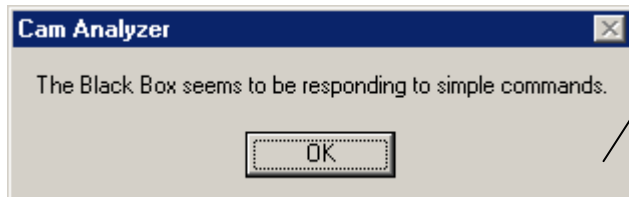

Response when it appears that the Black Box can read some very simple commands.

Appendix 5: New Features in v3.8

Cam Analyzer has had many updates since this user manual was written for the original v2.0 for Windows. These include 3.2A (Appendix 3), 3.2B (Appendix 4) and now v3.8 (Appendix 5). Here is a brief listing of some of the features new since v3.2B was released, including Version 3.8's new features.

Cam Analyzer v3.8 actually has 4 different versions now, which include:

- Cam Analyzer Basic
- Cam Analyzer Plus
- Cam Analyzer Basic with features to use the electronic Cam Test Stand sensors
- Cam Analyzer Plus with features to use the electronic Cam Test Stand sensors

Prior to this, all versions communicated to the Cam Test Stand, however the Plus version added very little to the user who did *not* have the Test Stand. Now the Plus version *does* add several features for users *not* using the Cam Test Stand.

Note that some of these new features apply only to the Plus Version of the software.

New Features for General Program Operation:

- The program now has an “EZ Start Wizard” to walk beginners through the steps of starting a new test. (Fig A20) This feature should greatly aid the user to understand all options which can affect the various tests they can run.
 - Added several features for emailing graphs, files and PDF reports (if you have the full Adobe Acrobat™ or some other software which offers a “PDF” printer option). (Fig A21)
 - Click on File at top main screen and you will see new Import and Export options. The Export command is similar to the old Create Cam Dr or Comp Cams files. The new v3.8 also includes creating S96 format files, “raw” data files for data from cams “Measured with Electronics”, exporting raw data at 1 crank degree (0.5 cam degree) intervals, and default location for the Engine Analyzer Pro v3.5's Cam Files. There are 2 raw data export options, Raw ‘As Measured’ data which is the measured data before any conversions, and Raw Converted data is the profile after any conversions (like virtual follower conversions) have been done. The Import command has 3 options, mainly explaining how you can open files of several different cam file formats, and one discussed in the paragraph below. (Fig A22)
 - Program will automatically look for old v3.2 files and copy them over to this new v3.8. You can also do this manually by clicking on File at top main screen, then Import, then Import All Files from a Cam Analyzer Program. (Fig A22)
 - Program now has a 'Website' button in the About screen for jumping to www.performancetrends.com website.
 - Program has added some new 'Edit' commands for copying cam data to and from the Cam Analyzer to other analysis programs.
 - One is the ability to right click on the top of the data columns in the lower left corner of the main screen, and select to copy the Lift Only or Lift and Degree data to the Windows Clipboard.
 - More include to click on Edit at top of main screen, then:
 - “Add To/Subtract From” to add or subtract a user defined amount of lift.
 - Make Mirror Image
 - Make Centerlines Equal (zero advance
- See Fig A23.
- The Preferences screen has grown, so we've now redone the layout to include tabs for the various groups of Preferences. (Fig A24)
 - Now when you switch between Inches and Millimeters for the Lift Increments in Preferences, the program also converts:
 - Specified lifts for the standard duration reports is also converted to the new lift units.
 - Dimensions in the Cam/Test Setup screen.

- Dimensions in the Virtual Follower screen.
- Program now has added Backup and Restore commands under File at the main screen. (Fig A22)
- The main screen now displays better for screen resolutions greater than 600 x 800.
- The screen colors are now more compatible with Windows XP.
- Now when you click on a graphed point on the main screen, the row for that data point gets highlighted in the table of results.
- Program now better remembers the printer type and printer page orientation when you make changes to the Windows Printer Setup.
- Program now has new preference to let you pick a Company Logo graphics file to appear in your printouts. The logo prints out in Graph printouts also. (Fig A24) Plus Version Only.
- There have been several refinements to the program to produce better looking printouts for graphs and reports.
- Updated the routine to locate an appropriate version of Adobe Acrobat™ to view the PDF files for the user manual.
- A new Preference has been added to allow you to change the line colors used for graphing and printing graph lines. (Fig A24)
- New Format option to Open/Save/Edit a particular graph format. This allows you to save the graph type, graph scales, etc to a particular name. Then you can easily Open these saved formats to reproduce a graph format in the future. This is available by clicking on Format, then Open/Save/Edit Graph Format. (Fig A25)
- The Graph screen now has a Format feature to display the “Legend” (line labels) on the right side in a larger font, and scroll up and down through the labels. Since the font is larger, not all labels can be displayed on the screen if several data types are being graphed. (Fig A26)
- The Graph screen can now accommodate up to 72 individual graph lines (data types). (Fig A26)
- Added several new features for writing ASCII files from reports. (Fig A27)
 - Report names can now include the path.
 - Now you can browse to find or create a file name and path for writing the ASCII file.
 - ASCII reports can now include the test comments.
 - Program now remembers ASCII file settings.
- The Preference which allows you to choose a default Floppy/CD drive has been expanded to include letter drives from A to Z.
- Program now prints headers of graphs and reports the same, and modifies the spacing to better ensure that long test file names are printed completely. As mentioned earlier, you can also include a company logo graphic image in the Plus Version.
- Made graph line flash rate independent of computer speed (.2 second flash rate).

New Outputs (Features for Graphs and Reports):

Note: All these new features apply Only to the Plus Version of Cam Analyzer.

- You can now Advance and Retard the cam profile after it has been “Measured with Electronics”. This is a very powerful feature for making adjustments and analysis after the cam has been measured. Plus Version Only. (Fig A28)
- You can convert most any cam data to the Cam Analyzer format of “Measured with Electronics”. This format has several of additional analysis options available (like the several new Report Types below), and also enables you to use the Virtual Follower calculations. This means that you can measure a cam profile by hand with the dial indicator directly on the cam lobe (no follower), convert it to this format, and then use the Virtual Follower calculations to see what this cam would do with various roller diameter followers, or OHC Rocker Arm geometries. This also means that you can *import* a cam profile measured by some other system (Andrews, Cam Dr, Cam Pro Plus, etc) with the encoder directly on the cam lobe (no follower), and do the same Virtual Follower calculations. Plus Version Only. (Fig A29)
- A new calculated output has been added of Asymmetry. Asymmetry is the measure of how much more aggressive the intake opening profile is than the exhaust closing profile. For a symmetric lobe, the opening and closing profiles are

the same (Asymmetry = 0). If the opening profile is more steep (aggressive), then the lobe may have, say, 4 degrees of asymmetry at a particular lift, say .050" lift. Technically this means the centerline at .050" lift is retarded from the centerline at the maximum lift point. Plus Version Only. (Fig A30)

- Several new Report Types have been added for the Plus Version Only, which include:
 - Lobe Analysis Report, similar to the Cam Profile Evaluation Program reports in Don Hubbard's book "Camshaft Reference Handbook" (Fig A31)
 - Custom Duration Report, which lets you specify up to 20 lifts at which to measure duration, opening and closing events. It also has options for the lifts to be tappet lift (like the standard duration report) or Valve Lift (correcting for lash and rocker arm ratio), and whether to include the new Asymmetry calculation. (Fig A32)
 - Seating Velocity Report, which calculates the valve closing velocity at several valve lashes of your choosing and 3 RPMs of your choosing. Don Hubbard's book "Camshaft Reference Handbook" gives some "rules of thumb" for acceptable seating velocities, which are included in the program. (Fig A33)
 - Checking Limits Report, which lets you design several checks to be made on the cam profile, like duration/opening event/closing event at a particular lift, maximum lift, centerline and lobe separation. This is a particularly useful report if you are checking cams to meet some quality control specs or to see if they are legal for particular race classes. (Fig A34)
- Added feature for doing Comparison Reports of one test versus another. (Fig A35) Plus Version Only.
- A new Graph menu option is "Analyze". At this time the only option under this heading is "Find Difference Between Lobes". If you have graphed the same type lobes (intake or exhaust) from 2 different tests, the program will find the matched pairs of lobes, like Intake #2 for both tests. It will then go through the difference in lift of both lobes at every 0.1 degrees and save the largest difference. Then it will advance or retard the second lobe with respect to the first lobe and do this comparison again until it finds the advance and retard which produces the lowest maximum difference. It will then report this maximum difference for each lobe pair. (Fig A36) Plus Version Only.
- A new "Watch Cam/Follower" screen lets you watch how the Virtual Follower is interacting with the measured cam profile. This new screen shows the instantaneous lift and rocker ratio both at each cam degree for the *cam* and now for the **actual contact point on the cam**. Data for the actual contact point shows more accurate instantaneous rocker arm ratios. (Fig A37) Plus Version Only.
- The Cam Card now includes duration at either .200 inches or 5 mm lift. (Fig A38) Plus Version Only.

New Features for Various Types of Cams, Cam Measurement Setups, and Electronics:

Note: Many new features in this section only apply to the Cam Analyzer version which has had the "Cam Test Stand" features activated.

- Two new methods of indexing the rotary encoder have been added. (Fig A39) These new methods are used instead of you specifying a particular event occurs at a particular degree for the #1 Intake Lobe, typically, say, 106 deg Centerline. These methods are:
 - User Finds TDC with Stops.
 - User Finds TDC with Sensor (typically for using the Performance Trends TDC Bridge) Plus Version Only.

For either method you will have a "Set TDC <F4>" option in the electronics Recording screen. You will click on the option or press <F4> key and the program will direct you through a series of steps to find TDC.

"User Finds TDC with Stops" is useful for measuring cams in the engine with a piston stop, or where you can place the rotary encoder exactly at TDC (for example by using the TDC mark on the engine damper). If you select this method, the program will ask you to rotate the crank or cam (and therefore the encoder as well) until the piston encounters the stop. Then it will ask you to rotate it the other way until it encounters the stop again. The program will split the difference and now know exactly where TDC occurs. If you can place the cam, crank or encoder at exactly TDC, you will do that for the first stop, and then *not* move the cam, crank or encoder at all and call it the second point. Splitting the difference of these 2 same points will produce these same 2 points as TDC.

“User Finds TDC with Sensor” is typically used with the Performance Trends TDC Bridge. It lets you turn the dowel pin or keyway used for timing the cam into a cam lobe. The Bridge is now a flat tappet follower. You place the linear encoder on the bridge, press <F4> and follow the program instructions. It finds the “centerline” of the dowel pin or key way and indexes the rotary encoder appropriately. Plus Version Only

Notes:

Most dowel pins or key ways are NOT positioned at TDC, but some degrees CW or CCW from TDC. You will need to know that positioning to use this feature. For some popular cam designs, Performance Trends has provided that timing in the Cam Layout Details screen.

Many aftermarket cams are NOT timed to the production timing of the dowel pin or keyway.

- The Cam Design Layout now has spots for entering the location of the dowel pin or keyway from TDC in so many degrees, and whether it is CW or CCW. See point immediately above. (Fig A40)
- The program now has several new Cam Types preloaded, like the 427 SOHC Ford, more generic 4 and 6 cylinder engines, more GM V-8s, etc.
- The program has had several refinements for better and more accurate operation with Millimeter lift increments, including:
 - Conversion of more data and settings from inches to millimeters and vice versa when you change the Millimeters/Inches Preference.
 - You can now create standard cam profiles from simple inputs like Lift, Duration at 1 mm, etc using Millimeters.
 - Virtual Follower features now work with Millimeter dimensions and lift measurements.
- The program can now better handle cams with just intake lobes, just exhaust lobes, or most any combination of lobes of up to 3 lobes for each cylinder, intake or exhaust. These options are required for DOHC and other more modern engine designs. Multiple lobes for the particular cylinder and designated A, B and C, like Int 1A, Int 1B, etc. (Fig A41)
- There is now a separate option for telling the program the cam you are measuring in either on the Cam Test Stand or In the Engine. The main difference are that if the cam is in the engine:
 - You do not need to know the Lifter Bore Angle Details. That is because the engine block and/or heads have the followers angled appropriately.
 - There is a good chance the linear encoder may *extend* when you are measuring lift, which could be on the valve itself or the follower. On the stand the encoder always *retracts* (is pushed in) as the follower is lifted.
 - There is a chance the rotary encoder could be mounted on the crankshaft or some other rotating component instead of the camshaft.

The first option can be selected in the Test/Cam Setup screen. If this is selected, then everything is done the same *except* the Lifter Bore Angle Details are not used for timing when the lobes for the different cylinders. However, the program may warn you that you should check the other 2 settings.

The second 2 options are available for setting in the Electronics Recording screen. If you select “Rotary Encoder Mounting as “Other Rotating Component”, then the program will ask you to rotate the cam until it sees the cam lobe repeat a second time. Then it will determine how many encoder rotations are equal to 1 cam rotation. All these options are available in the Basic Version except “Other Rotating Component”. (Fig A40)

- The Plus version allows you to set some “More (advanced) Options” from the Test/Cam Setup screen. (Fig A42) These 3 options are:
 - Typical Cam Lobe (opens and closes once) – default
 - or Cam Lobe may have 2 "bumps" (may open and close twice)
 - Just show data for Actual Lobe – default
 - or Show All data measured (all 400 deg)
 - Zero Lift is Average Lift Measured on Base Circle – default
 - or Zero Lift is Lowest Lift Measured on Base Circle

“Typical Cam Lobe (opens and closes once) – default” is a typical cam lobe with one opening and one closing profile. “Cam Lobe may have 2 "bumps" (may open and close twice)” is used when the lobe has 2 opening and closing profiles. This typically is used for Briggs and Stratton cams which have a small “Easy Pull” decompression lobe occur during the compression stroke.

When you record a cam lobe with electronics, the Cam Analyzer measures a full cam rotation plus 40 degrees more (360+40=400 cam degrees). The extra 40 degrees is to check for measurement accuracy. The program then goes through all this data and tries to find where the base circle stops and the opening and closing ramps exactly start. Typically you are not interested in graphing the base circle measurements because it takes up space on the graphs and reports. Then you would select “Just show data for Actual Lobe – default”. If you want to view all 400 degrees of measured data, you would select “Show All data measured (all 400 deg)”. One case in particular is when you have selected the option “Cam Lobe may have 2 "bumps" (may open and close twice)”.

Base circle of the cam is not exactly zero lift. There is some small variation in the base circle lift and this is caused “runout”. Up to now, the Cam Analyzer has used the AVERAGE base circle runout as the zero lift setting. Then you see small amounts of both positive and negative lift on base circle. For example if base circle runout was .002 inches, you should see lifts from -.001 to +.001 inches. That is the option of “Zero Lift is Average Lift Measured on Base Circle – default”. However, there are times you may want the very lowest lift measured on base circle to be zero lift, or “Zero Lift is Lowest Lift Measured on Base Circle”. One case in particular is when you have selected the option “Cam Lobe may have 2 "bumps" (may open and close twice)”.

- Added new label to the Valve Train Layout, where you can pick whether the cam rotates CW or CCW in the layout drawing. If you say the cam rotates CW in the drawing and the cam turns CW in the Cam Layout Details, then a label appears that the view of the valve train layout is from the Front of the engine. If you say the cam rotates CCW in the drawing and the cam turns CW in the Cam Layout Details, then a label appears that the view of the valve train layout is from the Rear of the engine.
- Added new ‘Clc’ button in the Valve Train Layout screen to allow you to calculate the required of Angle and Distance for various pivot points based on X and Y dimensions.
- Added option to customize the calibration of the linear (lift) sensor in the Tester Calibration screen.
- The program will now work with some models of the Cam Pro Plus TM electronics.
- Program now does more extensive checking of valid com ports for communicating to Performance Trends Black Box and Black Box II. It checks up to Com Port 16, and gives better suggestions at valid ports. There is also a “Find” button in the Test Calibration specs screen to find your electronics by checking all available Com Ports. This feature is in the Basic version also, but only with the Measure with Electronic Sensors feature added.

Fig A20 Starting a New Test Using the EZ Start Wizard

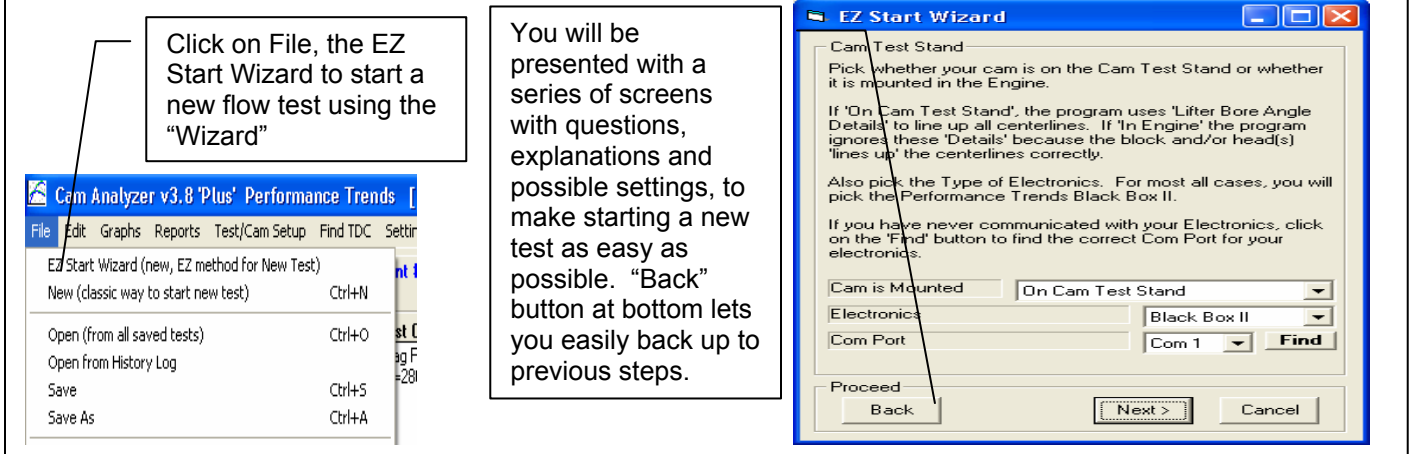

Figure A 21 Emailing Options

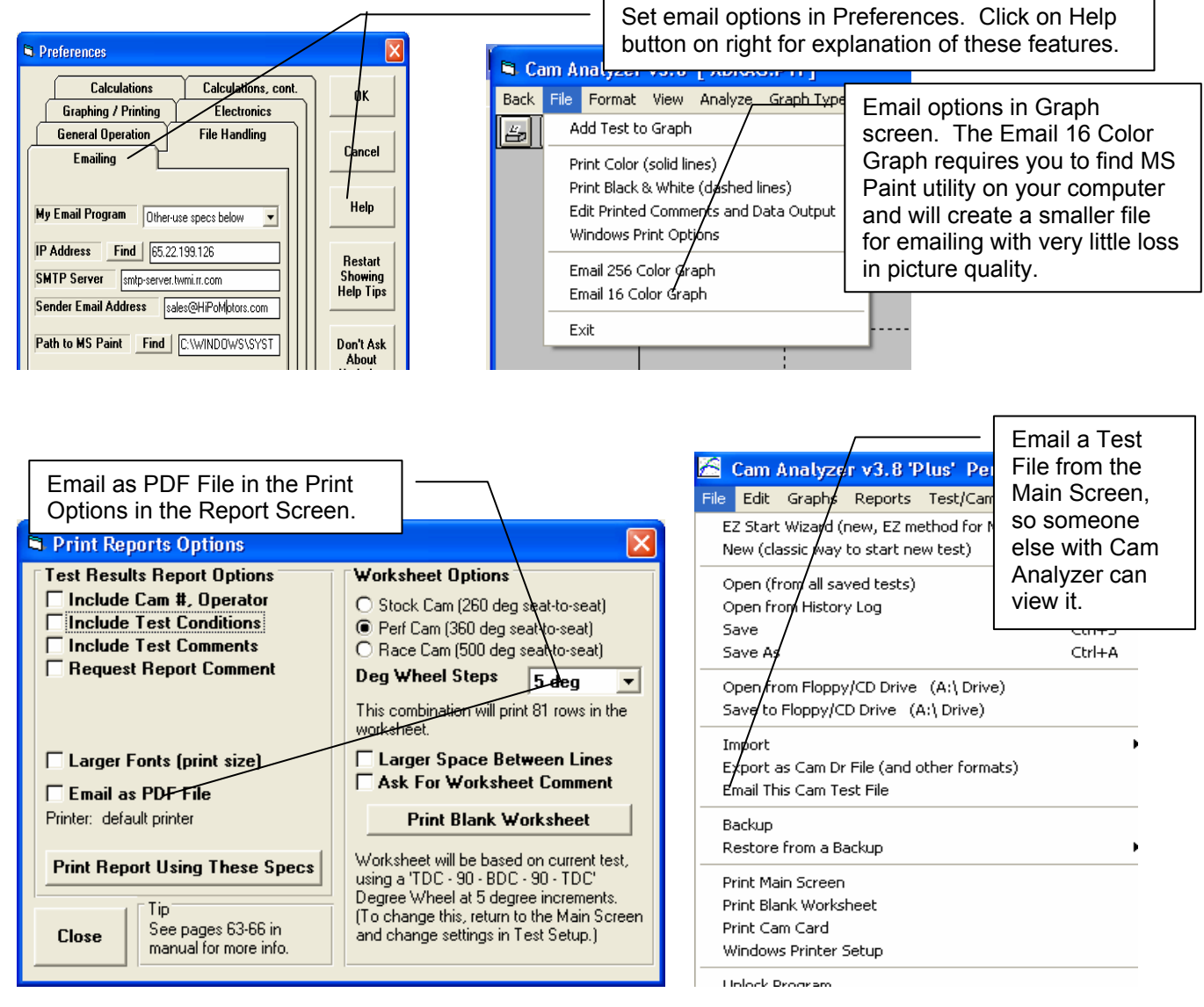

Figure A22 Some New Features on the Main Screen

The image shows a screenshot of the Cam Analyzer v3.8 'Plus' software interface. The main window displays a menu bar with 'File', 'Edit', 'Graphs', 'Reports', 'Test/Cam Setup', 'Find TDC', and 'Set'. The 'File' menu is open, showing options like 'EZ Start Wizard', 'New', 'Open', 'Save', 'Import', 'Export as Cam Dr File', 'Email This Cam Test File', 'Backup', 'Restore from a Backup', 'Print Main Screen', and 'Print Blank Worksheet'. A callout box points to the 'Import' option, stating: 'New Import Commands to import Cam Dr, Cam Pro Plus, Doctor Dr, Andrews, S96 files and import files from an earlier version of Cam Analyzer, like v3.2. This makes it easy to pull all your v3.2 files over to the new version 3.8.' Another callout points to the 'Restore from a Backup' option, stating: 'New Backup and Restore Commands.' A third callout points to the 'Export as Cam Dr File' option, stating: 'New Options for exporting Raw data'. To the right, an 'Export File Options' dialog box is open, showing 'Cam File Specs' with fields for 'Format' (Raw Converted data), 'File Name' (Scott Evans.txt), and 'Browse' button. A callout points to the 'Format' dropdown, stating: 'Raw Data options for cams "Measured with Electronics"'. Other options in the dialog include 'Include .MSU and .DES Files' (Yes), 'Lobe to Use' (Cylinder 5), 'Create data for every Crank Deg' (No), 'Limit to One Cam Rev' (Yes), and 'Include' (Lift, line # and Cr Deg). A 'Note' section at the bottom of the dialog states: 'The Cam Dr or Comp Cams file created is based...'

Figure A23 Options to Edit, Copy or Paste Data

Cam Analyzer v3.8 'Plus' Performance Trends [XDRAG.PTI]

File Edit Graphs Reports Test/Cam Setup Find BTDC Settings Help Run Test/Key Control

Test & Valve Train Conditions
Test Time/Date 12:42 PM 02/07/19
Cam Number CompCam00457
Grind Number .31957
Rckr Ratio/Lash 1.5 / .020
Test Operator Jack

Test Data
EZ Data Entry Ge

Point	Degree Wheel	Tappet Lift
1	85. BTDC	.002
2	180 BTDC	.005

Copy to Windows Clipboard Copy Lifts Only
Other Edit Options Copy Lifts and Degrees

Left click on each column heading for different Edit options to be presented, like the one to the right.

Right click on the top of a data column for these Options. If you select "Other" you get the screen below.

Edit Test Data

Erase Column Text1

Advance

Retard

Cancel Use This Data Cancel

Cancel

Click into Text Box above to place cursor there. Then do a 'Ctrl-C' to copy the lift data there. Click on the 'Use This Data' button to copy lift data to lift column for this lobe.

Click on Advance or Retard and program asks how many degrees.

Edit Test Data

Copy to Clipboard

Erase Column

Paste from Another Program

Paste from Clipboard

Cancel

Use This Data Cancel

Click into Text Box above to place cursor there. Then do a 'Ctrl-C' to copy the lift data there. Click on the 'Use This Data' button to copy lift data to lift column for this lobe.

'Copy to Clipboard' lets you copy these lifts to some other lobe (int or exh) to this or any other cam file.

Cam Analyzer v3.8 'Plus'

File Edit Graphs Reports Test/Cam Setup Find BTDC Settings Help Run Test/Key Control

Copy or Swap Lobes

Add/Delete Rows of Data

Adv/Ret/Delete Deg Wheel Readings

Copy/Delete/Paste Tappet Lifts

Convert Lift Inches to Millimeters

Convert Lift Millimeters to Inches

Multiply Lift by a Factor

Add to/Subtract from Lift

Round Off Lift

Make Centerlines Equal (0 advance)

Make Mirror Image

Point	Degree Wheel	Tappet Lift

Several new Options if you click on Edit at top of main screen.

Figure A24 Printing Company Logo on Graphs and Reports

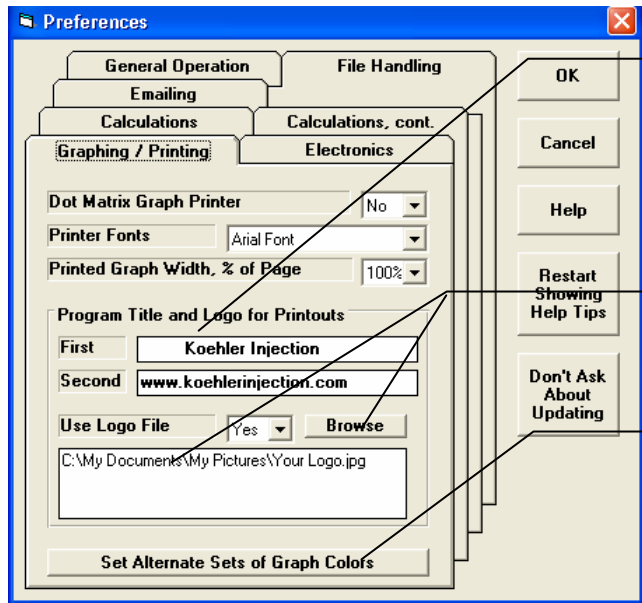

In Preferences, set text to be included in Printouts.

Use Browse button to find your graphics file on this computer.

Click here for a new screen, where you can change the colors used to graph and print data lines on the graphs.

Graphics file is drawn here on printed reports.

Two lines of text from Preferences is printed here in printouts.

Your Logo Goes Here Cam Test: Koehler Injection
 Folder: EXAMPLES Performance Trends (c) 2008
 This Report Printed: 9:20 am 06-30-08 Page: 1

Report of:	Cyl 1, Cam Data	Test Time:	12:42 PM	02/07/1994	Events Rated at	.05" Tappet Lift					
CLine	Dur	Open	Close	Lb Area	Lb Lift	Vlv Lift	RAR	Lash	LbSep/Adv	Overlap	ASym
Int: 103.8	279.7	36.2	63.6	42.23	.470	.705	1.5	.020	105.1	76.8	-.13
Exh: 106.3	293.0	72.4	40.6	40.89	.423	.677	1.6	.022	1.2	Advance	.39

Figure A25 Opening and Saving a Graph Format

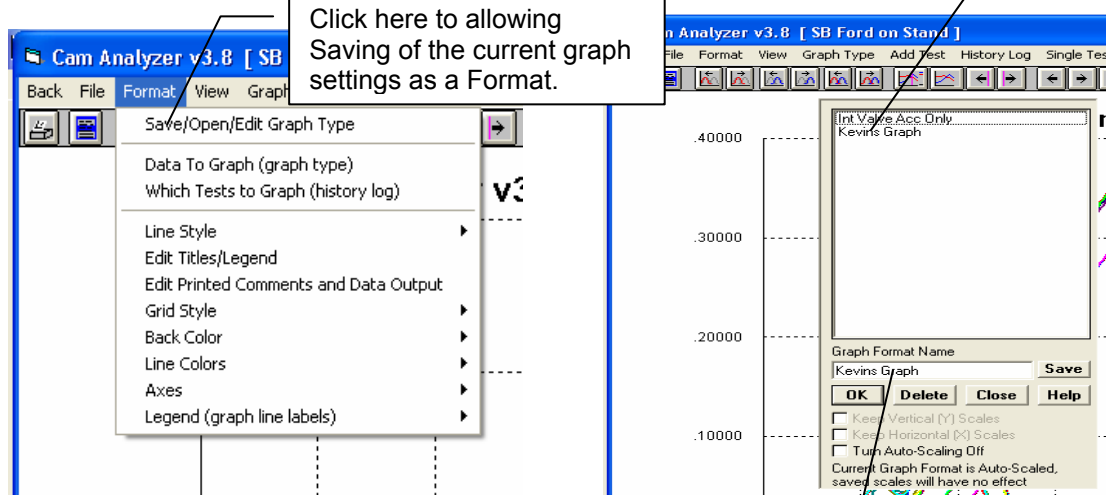

Click here to allowing Saving of the current graph settings as a Format.

To open a saved format, click on the format name from the list, then click on OK. Do the same but click on Delete to delete that saved Format.

Type in a name for the current graph settings, then click on Save to save them under that name and add it to the list.

Figure A 26 Larger Graph Legend and Graphing up to 72 Data Types

This graph shows Intake and Exhaust Lift and Acceleration for 2 V-8 Cams (64 Data Types)

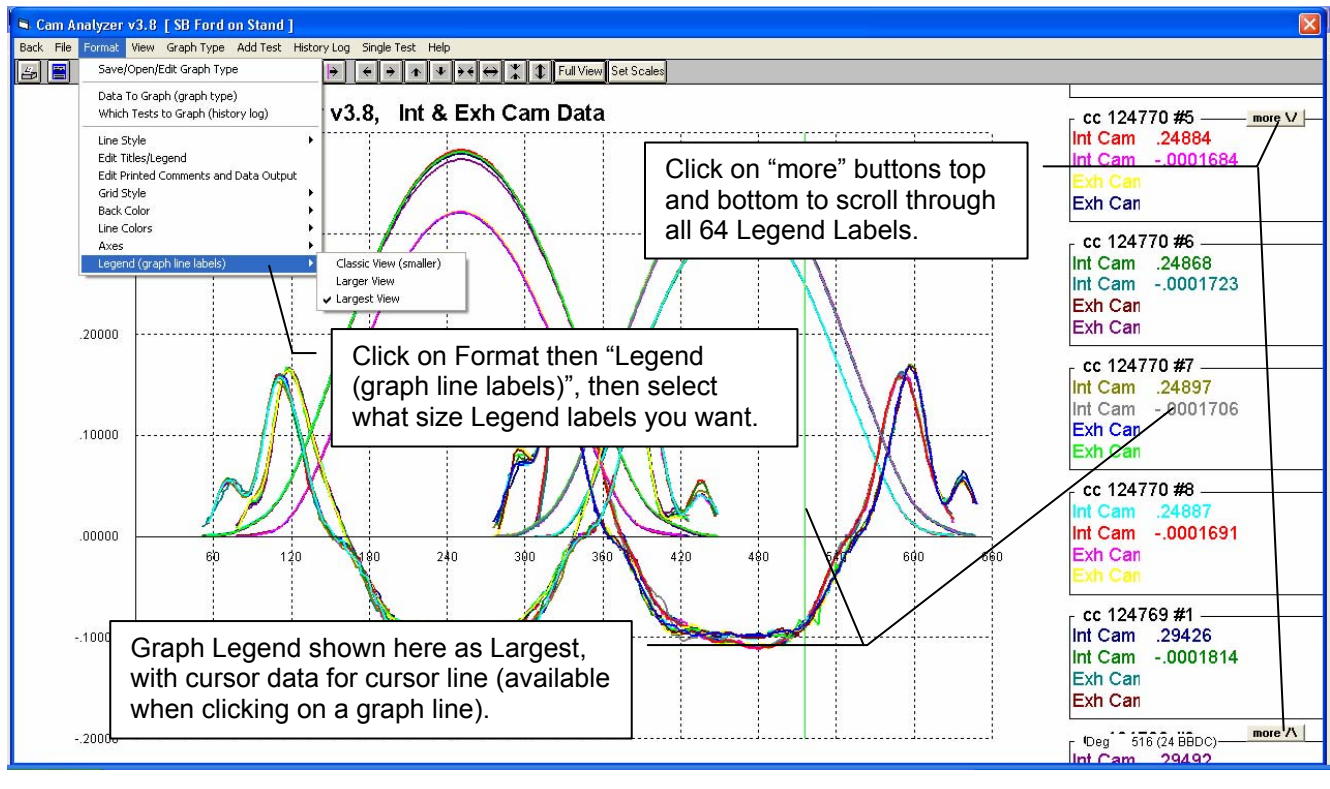

Figure A27 New Features for Writing ASCII Files of Report Data

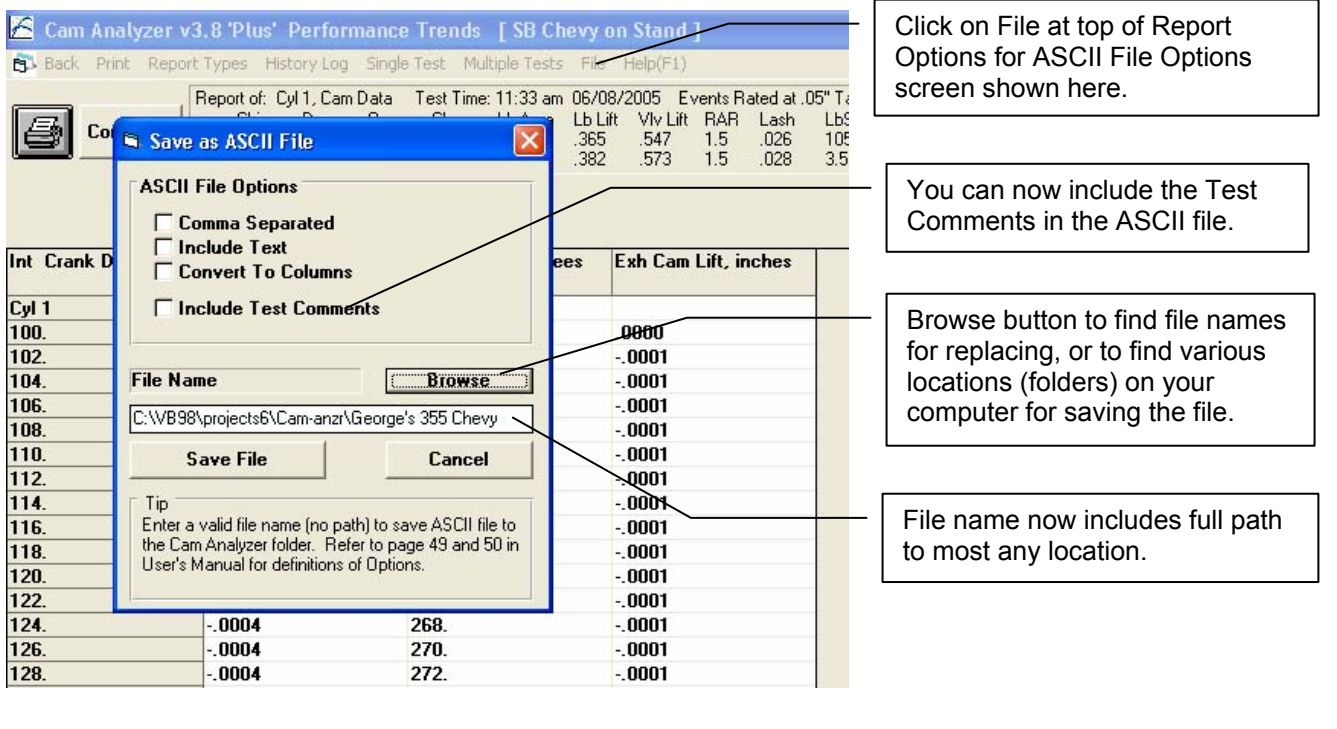

Figure A28 Advancing and Retarding Measured Data, and other Test/Cam Setup Options

The screenshot shows the 'Test Options' dialog box with the following settings:

- Test Setup**
 - Type of Cam Data: Measured with Electronics
 - Lifter (profile) Type: Mild Solid Flat
 - Rocker Arm Ratio: Intake 1.6, Exhaust 1.6
 - Actual Valve Lash, in: Intake .026, Exhaust .028
- Electronic Measurement Settings**
 - TDC Method: Intake Centerline
 - Cam Timing Value: 105
 - Cam Design: Small Block Ford
 - Number of Cylinders To Test: 8
 - Adjust Timing from Timing when Measured: 2.3 (2.3 deg advanced)
 - Measure Cam...: On Cam Test Stand
 - More Options: Options set to std Defaults
- Buttons:** Lifter Bore Angle Details, Camshaft Layout Details, See Virtual Follower Details, Save, Open, Delete, Adv/Ret

Callout boxes provide additional information:

- Top Callout:** These options are only available if the cam has been "Measured with Electronics", or has been converted from another format with the Plus Version's conversion.
- Middle Callout:** Click here for More Advanced Options (listed in descriptions in the text on a previous page. You must turn On a Preference first before this "More Options" button is displayed.
- Bottom Callout:** Click here to specify if the cam is being measured on the Cam Test Stand or In the Engine.
- Right Callout:** Click on the Advance/Retard button for options shown. Select "Allow..." to allow input to the left of the button, where you specify the amount you want to Advance or Retard the "as measured" data. The data will be Advanced or Retarded when you back out of this screen. The amount you enter here is the Total change from when the data was recorded. If you specify Adv of 3 degrees, then several days later a Retard of 1.5 degrees, the total change at that time will be Retarding it 4.5 degrees.

Figure A29 Converting Cam Data to "Measured with Electronics"

Select "Measured with Electronics" to start converting to that format. The program will warn you and then ask if you want to continue in screen below.

If you answer Yes, the conversion starts as shown here.

Change Type of Cam Data Anyway?

The program will now convert your data to a format much like it was Measured with Electronic Sensors (800 crank degrees, 2 deg increments, etc). This will be a major change to the data, but will allow you to do additional types of analysis. After this change, you will NOT be able to return to the original data.

It is recommended you save this data, and then save again to a New Name before you continue. That way you CAN go back to your old data file if need be.

Are you sure you want to make this change to the Type of Cam Data now?

Yes No

After the conversion, some of the features available to data actually "Measured with Electronics" are now available. These include the Virtual Follower features, and the More Options, and many other types of Reports.

The program shows here that the data was NOT actually "Measured with Electronics", but converted from another type of data.

Back at the Main Screen, a generic 1 cylinder cam with 1 Intake and 1 Exhaust Lobe. Here also the program shows that the data was NOT actually "Measured with Electronics", but converted from another type of data.

Figure A30 Definition of Asymmetry

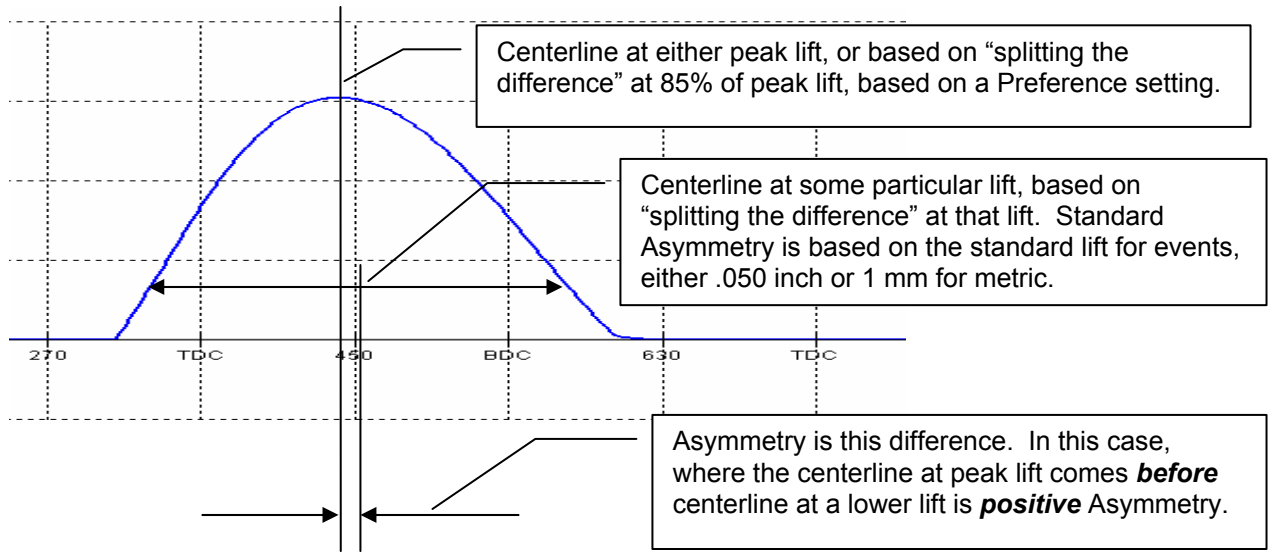

Figure A31 Lobe Analysis Report of **Cam Lobe** Data

<i>Goetz Logo</i>		Cam Analyzer v3.8		Koehler Injection		This Report Printed:					
<i>Goetz Name</i>		Test: SB Chevy on Stand		www.koehlerinjection.com		2:13 pm 06-30-08					
		Folder: EXAMPLES		Performance Trends (c) 2008		Page: 1					
Report of: Cyl 1, Valve Data		Test Time: 11:33 am		06/08/2005		Events Rated at .05" Tappet Lift					
CLine	Dur	Open	Close	Lb Area	Lb Lift	Viv Lift	RAR	Lash	LbSep/Adv	Overlap	ASym
Int: 102.0	259.0	27.4	51.6	32.21	.365	.547	1.5	.026	105.5	52.5	0.08
Exh: 109.0	268.0	62.9	25.1	34.51	.382	.573	1.5	.028	3.5 Advance		0.04

	I 1	E 1
Max Tappet Lift, in	.3649	.3819
Centerline (int=ATDC, exh=BTDC)	102.00	108.98
Base Circle Runout, in	.0018	.0005
Max Opening Vel, in/deg	6.991	6.957
Max Closing Vel, in/deg	7.012	6.930
Min Radius of Curvature, in		
Min Rad. Curv. occurs at		
Contact Pt Movement (open), in		
Contact Pt Movement (close), in		
Opening at .006, in	57.94	99.57
Closing at .006, in	90.02	66.45
Opening Vel at .006, in/deg	1.51	1.10
Closing Vel, .006, in/deg	-.97	-.88
Opening at .01, in	52.86	92.85
Closing at .01, in	83.34	58.73
Opening Vel at .01, in/deg	1.75	1.35
Closing Vel, .01, in/deg	-1.27	-1.12
Opening at .02, in	43.33	80.48
Closing at .02, in	69.85	43.56
Opening Vel at .02, in/deg	2.85	2.24
Closing Vel, .02, in/deg	-2.19	-2.09
Opening at .050, in	27.41	62.93
Closing at .050, in	51.57	25.05
Asymetry at .050, in	0.08	0.04
Opening at .200, in	-17.87	16.99
Closing at .200, in	5.98	-21.02
Asymetry at .200, in	-.07	-.02
Max Opening Accel, in/deg^2	.308	.321
Max Accel over Nose, in/deg^2	-.203	-.211
Max Closing Accel, in/deg^2	.334	.339
Area Above .050 in, in-deg	24.98	26.91
Duration at .004 in, in-deg	335.42	354.27
Duration at .006 in, deg	327.96	346.02
Duration at .01 in, deg	316.20	331.58
Duration at .02 in, deg	293.18	304.04
Duration at .050 in, deg	258.97	267.98
Duration at .100 in, deg	225.45	233.95
Duration at .200 in, deg	168.12	175.96
Duration at .300 in, deg	103.44	114.37
4-50 Index, deg	76.45	86.29
10-50 Index, deg	57.23	63.60
20-50 Index, deg	34.21	36.06

Basic "summary" of these lobes

These outputs are not calculated unless you have measured the cam with the linear encoder **directly** and then used the Virtual Follower feature to calculate the lobe.

Data for estimating performance of opening and closing ramps, at some standard lifts. Remember these are **cam** lifts and not **valve** lifts so are not equal to these valve lash settings.

Events at more standard lifts, and Asymmetry. Velocities not given because these lifts are not close to typical valve lash settings.

More standard measurements for these lobes.

The Indexes are calculated from the subtracting the duration at .050" from the duration at .004, .010 and .020 inches. The larger these number, the more "gentle" the ramp at that lift.

Figure A 32 Custom Duration Report

Here you can select the type of report to make.

More Report Options

Custom Duration		Seating Velocity		Checking Limits	
Lift 1	.004	Lift 11	.014		
Lift 2	.005	Lift 12	.015		
Lift 3	.006	Lift 13	.016		
Lift 4	.007	Lift 14	.017		
Lift 5	.008	Lift 15	.018		
Lift 6	.009	Lift 16	.019		
Lift 7	.200	Lift 17	.020		
Lift 8	.011	Lift 18	.021		
Lift 9	.012	Lift 19	.022		
Lift 10	.013	Lift 20	.050		

Valve or Cam Lifts? Cam

Include Asymetry Calculation Yes

Help
Enter a lift for which this report will find the Duration, Opening Event and Closing Event (and Asymetry if requested).

OK Cancel Help Get Settings Save Settings Print

More Report Settings

For the Advanced Reports (bottom 3 in the drop down list shown on this screen), a "More Report Settings" button is displayed. Click on it for the "More Report Options screen shown to the upper right.

Cam Analyzer v3.8 'Plus' Performance Trends [SB Chevy on Stand]

Back Print Report Types History Log Single Test Multiple Tests File Help(F1)

Report of: Cyl 1, Cam Data Test Time: 11:33 am 06/08/2005 Events Rated at .05" Tappet Lift

CLine	Dur	Open	Close	Lb Area	Lb Lift	Vlv Lift	RAR	Lash	LbSep/Adv	Overlap	ASym
Int: 102.0	259.0	27.4	51.6	32.21	.365	.547	1.5	.026	105.5	52.5	0.08
Exh: 109.0	268.0	62.9	25.1	34.51	.382	.573	1.5	.028	3.5 Advance		0.04

Cam Lift	Int Open BTDC	Int Close ABDC	Int Dur	Int Asym	Exh Open BBDC	Exh Close ATDC	Exh Dur	Exh Asym
Cyl 1								
.004	61.2	94.2	335.4	4.5	103.4	70.8	354.3	2.7
.005	59.5	91.9	331.4	4.2	101.4	68.5	349.9	2.5
.006	57.9	90.0	328.0	4.1	99.6	66.4	346.0	2.4
.007	56.6	88.3	324.8	3.9	97.7	64.5	342.2	2.4
.008	55.3	86.5	321.8	3.6	95.9	62.5	338.5	2.3
.009	54.0	84.9	318.9	3.5	94.4	60.5	334.9	2.0
.200	-17.9	6.0	168.1	-1	17.0	-21.0	176.0	.0
.011	51.7	81.7	313.5	3.0	91.4	56.9	328.3	1.7
.012	50.7	80.1	310.8	2.7	90.0	55.1	325.2	1.5
.013	49.6	78.7	308.3	2.6	88.7	53.4	322.1	1.3
.014	48.6	77.3	305.9	2.4	87.4	51.8	319.2	1.2
.015	47.7	75.9	303.5	2.1	86.1	50.2	316.3	1.0
.016	46.7	74.5	301.2	1.9	84.9	48.7	313.6	.9
.017	45.8	73.2	299.0	1.7	83.7	47.3	311.0	.8
.018	45.0	72.0	297.0	1.5	82.6	45.9	308.5	.6
.019	44.1	70.9	295.0	1.4	81.5	44.7	306.2	.6
.020	43.3	69.8	293.2	1.3	80.5	43.6	304.0	.5
.021	42.6	68.9	291.4	1.2	79.5	42.5	302.0	.5
.022	41.8	67.9	289.7	1.1	78.6	41.5	300.1	.4
.050	27.4	51.6	259.0	.1	62.9	25.0	268.0	.0

Figure A33 Seating Velocity Report

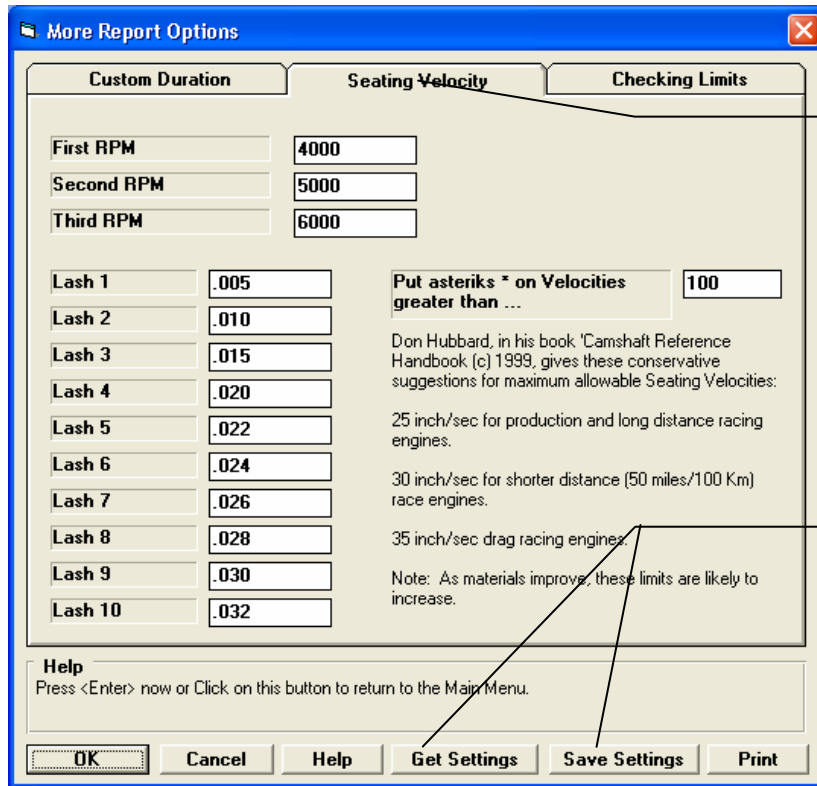

This screen has 3 tabs for the 3 different Report Types which use these additional settings.

You can either Save settings, or Get some previously Saved settings by clicking on these buttons. You will only Save or Open settings for one particular tab. That means if you save Seating Velocity settings, you are not saving Custom Duration or Checking Limits settings.

Cam Analyzer v3.8 'Plus' Performance Trends [SB Chevy on Stand]

Back Print Report Types History Log Single Test Multiple Tests File Help(F1)

Report of: Cyl 1, Valve Data Test Time: 11:33 am 06/08/2005 Events Rated at .05" Tappet Lift

	CLine	Dur	Open	Close	Lb Area	Lb Lift	Vlv Lift	RAR	Lash	LbSep/Adv	Overlap	ASym
Int:	102.0	259.0	27.4	51.6	32.21	.365	.547	1.5	.026	105.5	52.5	0.08
Exh:	109.0	268.0	62.9	25.1	34.51	.382	.573	1.5	.028	3.5 Advance		0.04

Lash	Vel @ 4000 RPM, int	Vel @ 5000 RPM, int	Vel @ 6000 RPM, int	Vel @ 4000 RPM, exh	Vel @ 5000 RPM, exh	Vel @ 6000 RPM, exh
Cyl 1						
.005	57.68	72.10	86.52	60.79	75.98	91.18
.010	62.33	77.92	93.50	65.39	81.74	98.08
.015	66.44	83.05	99.66	69.14	86.43	103.72 *
.020	69.78	87.22	104.66 *	72.51	90.63	108.76 *
.022	71.00	88.75	106.51 *	73.66	92.08	110.49 *
.024	72.23	90.29	108.35 *	74.82	93.52	112.23 *
.026	73.38	91.73	110.07 *	75.97	94.97	113.96 *
.028	74.47	93.08	111.70 *	77.07	96.34	115.61 *
.030	75.55	94.44	113.32 *	78.11	97.64	117.17 *
.032	76.63	95.79	114.95 *	79.15	98.94	118.72 *

Check out Don Hubbard's book "Camshaft Reference Handbook" for lots of cam design suggestions. In it he talks about seating velocity and choosing an acceptable one for durability. The velocity in inches per second (or mm per second) changes with the engine RPM you are running. That is why you can enter up to 3 RPMs for checking. The Valve Lashes you enter are actual valve lash, and not tappet lifts. These valve lashes will change as you change the Rocker Arm Ratio setting in the Test/Cam Setup screen.

Figure A34 Checking Limits Report

Choose which type of check you want to make, or choose "None" for no check.

Choose if you want the check done on the Intake, Exhaust or both lobes.

Enter the Minimum and Maximum values which are acceptable. Values outside this range will be flagged out in the report.

Depending on your choice, you may be able to enter an "At this Lift" value, like Duration at .100 tappet lift.

Cam Analyzer v3.8 'Plus' Performance Trends [SB Chevy on Stand]

Report of: Cyl 1, Valve Data Test Time: 11:33 am 06/08/2005 Events Rated at .05" Tappet Lift

	CLine	Dur	Open	Close	Lb Area	Lb Lift	Vlv Lift	RAR	Lash	LbSep/Adv	Overlap	ASym
Int:	102.0	259.0	27.4	51.6	32.21	.365	.547	1.5	.026	105.5	52.5	0.08
Exh:	109.0	268.0	62.9	25.1	34.51	.382	.573	1.5	.028	3.5 Advance		0.04

	Int Centerline	Int Close Event (.200)	Exh Duration (.100)	Exh Lobe Separation
Cyl 1	102.00 = Pass	5.98 = Pass	233.77 = Pass	105.48 = Pass
Cyl 2	102.04 = Pass	6.24 > 6	233.77 = Pass	105.48 = Pass
Cyl 3	101.72 < 101.8	5.71 = Pass	234.59 = Pass	105.54 > 105.5
Cyl 4	101.94 = Pass	5.76 = Pass	234.59 = Pass	105.54 > 105.5
Cyl 5	102.17 = Pass	5.40 = Pass	234.09 = Pass	105.80 > 105.5
Cyl 6	102.46 > 102.2	5.99 = Pass	233.69 = Pass	105.76 > 105.5
Cyl 7	102.17 = Pass	5.76 = Pass	233.39 = Pass	105.73 > 105.5
Cyl 8	101.90 = Pass	5.71 = Pass	234.18 = Pass	105.51 > 105.5

"Pass" means the value is within limits

If the value is greater than the limit, the greater than sign ">" is given with the acceptable limit it violated.

If the value is less than the limit, the less than sign "<" is given with the acceptable limit it violated.

Figure A35 Comparison Reports Between Different Test Files

Report of: Cyl 1, Cam Data, Test Time

Line	Dur	Open	Close
Int: 102.0	268.0	27.4	51.6
Exh: 109.0	268.0	62.9	25.1

Click on History Log to display History Log below to pick which tests to include in the comparison report.

Cam Lift	Int Open BTDC	Int Close ABDC	Int Dur	Exh Open BBDC	Exh Close ATDC	Exh Dur
Cyl 1						
.001	68.6	107.9	356.4	112.5	81.6	374.1
.000	72.0	235.3	487.3	253.6	180.8	614.4
.000	72.0	235.3	487.3	253.6	180.8	614.4
.000	72.0	235.3	487.3	253.6	180.8	614.4
.000	72.0	235.3	487.3	253.6	180.8	614.4
.000	72.0	235.3	487.3	253.6	180.8	614.4
.050	27.4	51.6	259.0	62.9	25.0	268.0
.100	10.8	34.7	225.4	45.9	8.1	234.0
.150	-3.6	20.2	196.6	31.4	-6.6	204.7
.200	-17.9	6.0	168.1			
.250	-32.7	-8.8	138.5			
.300	-50.3	-26.3	103.4			

Click in this "Graph?" column to include that particular test in the comparison report.

Test File and Path	Graph?	Std Graph Title	Save?	Cam #	# Cyl	Cyl to Graph	Int Lift	Dur	Test Date	Exh Lift	Dur	File Type
...ata\examples\SB Chevy on Stand	Yes	cc 124769		CC 124769	8	1	.373"	259.1	06/08/2005	.380"	268.5	Measured with Electronics
...camdata\Honda\SB Ford on Stand		cc 124770		CC 124770	1	1	.305"	256.6	06/08/2005	.000"	.0	Measured by Hand
...data\examples\SB Ford on Stand	Yes	cc 124770		CC 124770	8	1	.320"	228.6	06/08/2005	.321"	232.8	Measured with Electronics
...nzn\camdata\example\VD RAG.PTI		compcam00457		CompCam00457	1	1	.470"	279.7	02/07/1994	.423"	293.1	Measured by Hand
...tronics Conversions\VD RAG.PTI		compcam00457		CompCam00457	1	1	.470"	330.5	02/07/1994	.423"	338.0	Measured with Electronics
...nics Conversions\VD RAG.PTI.002		compcam00457		CompCam00457	1	1	.000"	.0	06/26/2008	.000"	.0	Measured with Electronics
...ans\EVO VIII FP 271 Intake da							1.3	01/28/2008	.000"	.0	.0	Measured with Electronics
...My-Tests\sb ford on stand 001								06/27/2008	.000"	.0	.0	Measured with Electronics
...s\Try built in Dowel Pin info								06/27/2008	.000"	.0	.0	Measured with Electronics
...anr\camdata\My-Tests\Pontiac		cc 124769		CC 124769	8	1	.373"	259.1	06/08/2005	.380"	268.5	Measured with Electronics
...nics Conversions\VD RAG.PTI.001		compcam00457		CompCam00457	1	1	.300"	199.7	06/27/2008	.333"	222.0	Measured with Electronics
...anr\camdata\Wizard\Kevin 001		kevin2		Kevin2	8	1	.000"	.0	06/27/2008	.000"	.0	Measured with Electronics
...Cam-anr\camdata\Wizard\Kevin		kevin2		Kevin2	1	1	.000"	.0	06/27/2008	.000"	.0	Measured with Electronics
...My-Tests\sb chevy on stand 009		cc 124769		CC 124769	8	1	.000"	.0	06/27/2008	.000"	.0	Measured with Electronics
...My-Tests\sb chevy on stand 008		cc 124769		CC 124769	8	1	.000"	.0	06/27/2008	.000"	.0	Measured with Electronics
...my-tests\sb chevy on stand 007		cc 124769		CC 124769	8	1	.000"	.0	06/25/2008	.000"	.0	Measured with Electronics

Then click on "Graph Tests Marked Yes"

Report of: Cyl 1, Cam Data, Test Time

Line	Dur	Open	Close	AR	Lash	LbSep/Adv	Overlap	ASym
Int: 102.0	259.0	27.4	51.6	1.5	.026	105.5	52.5	0.08
Exh: 109.0	268.0	62.9	25.1	1.5	.028	3.5 Advance		0.04

Click on Multiple Tests and choose which type to make. In this example, we're including the "Difference" calculation.

Cam Lift	SB Chevy on Stand	SB Ford on Stand	Dif.
Cyl 1			
.003	63.0	33.7	-29.3
.004	61.2	32.5	-28.7
.006	57.9	30.5	-27.4
.015	47.7	23.7	-24.0
.020	43.3	21.0	-22.3
.040	31.6	12.4	-19.2
.050	27.4	8.7	-18.7
.100	10.8	-7.0	-17.8
.150	-3.6	-21.5	-17.9
.200	-17.9	-36.5	-18.6
.250	-32.7	-54.0	-21.3
.300	-50.3	-79.5	-29.2
.350	-77.6		

Click on Single Test to turn Off Multiple Tests.

Cam Lift	Int Close ABDC	Int Close ABDC	Dif.
Cyl 1			
.003	96.8	74.9	-21.9
.004	94.2	71.8	-22.4
.006	90.0	67.4	-22.6
.015	75.9	56.9	-19.0
.020	69.8	53.3	-16.5
.040	56.0	43.1	-12.9
.050	51.6	39.1	-12.5
.100	34.7	22.7	-12.0
.150	20.2	7.7	-12.5
.200	6.0	-7.4	-13.4
.250	-8.8	-24.4	-15.6
.300	-26.3	-48.9	-22.6
.350	-53.2		

Cam Lift	Int Dur	Int Dur	Dif.
Cyl 1			
.003	339.8	288.6	-51.2
.004	335.4	284.3	-51.1

Figure A36 Analyze Feature on Graph Screen

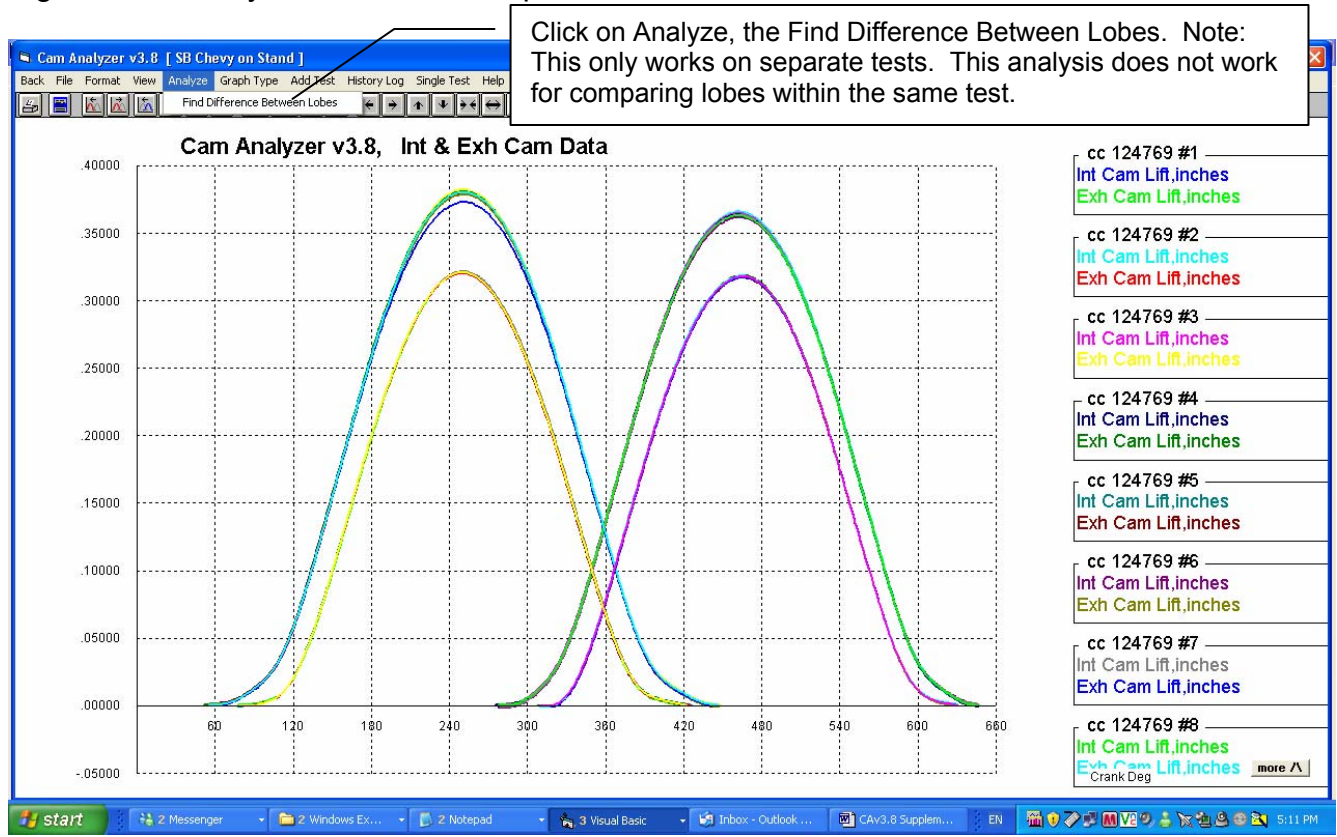

The Difference found are given in a Notepad text file so you can choose to print them, save them or copy them as needed.

```
AnalyzeCam.txt - Notepad
File Edit Format View Help
Comparing Graph Data:
Baseline: SB Chevy on Stand
Comparison: SB Ford on Stand

Baseline: cc 124769 #1
Comparison: cc 124770 #1
Base: Int Cam Lift,inches .23426 at 536. deg
Comp: Int Cam Lift,inches .18024 at 538.6 deg
Max Difference .05403 at 2.6 deg Advance

Base: Exh Cam Lift,inches .30054 at 194. deg
Comp: Exh Cam Lift,inches .23743 at 193.2 deg
Max Difference .06311 at 0.8 deg Retard

Baseline: cc 124769 #2
Comparison: cc 124770 #2
Base: Int Cam Lift,inches .24158 at 534. deg
Comp: Int Cam Lift,inches .18753 at 536.4 deg
Max Difference .05405 at 2.4 deg Advance

Base: Exh Cam Lift,inches .28302 at 314. deg
Comp: Exh Cam Lift,inches .21927 at 312.6 deg
Max Difference .06375 at 1.4 deg Retard

Baseline: cc 124769 #3
Comparison: cc 124770 #3
Base: Int Cam Lift,inches .23977 at 534. deg
```

Figure A37 Watch Virtual Follower Screen

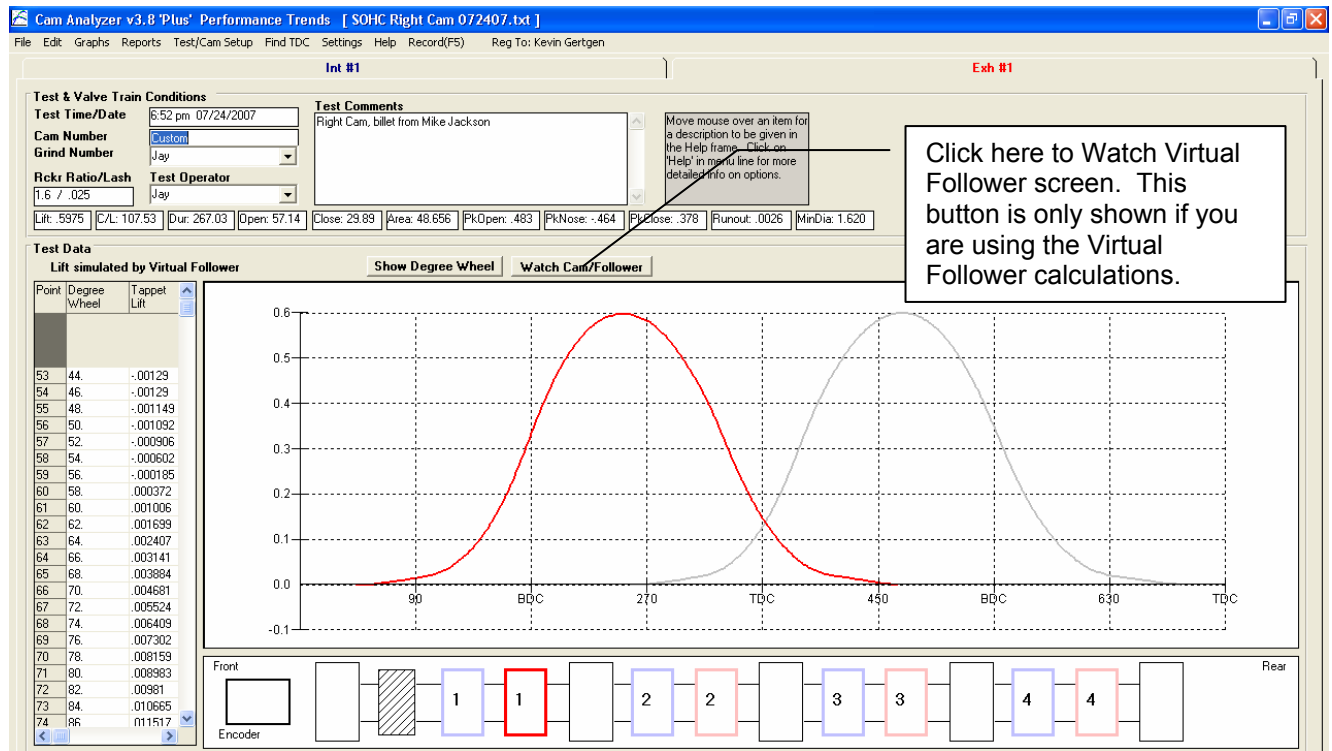

Click here to Watch Virtual Follower screen. This button is only shown if you are using the Virtual Follower calculations.

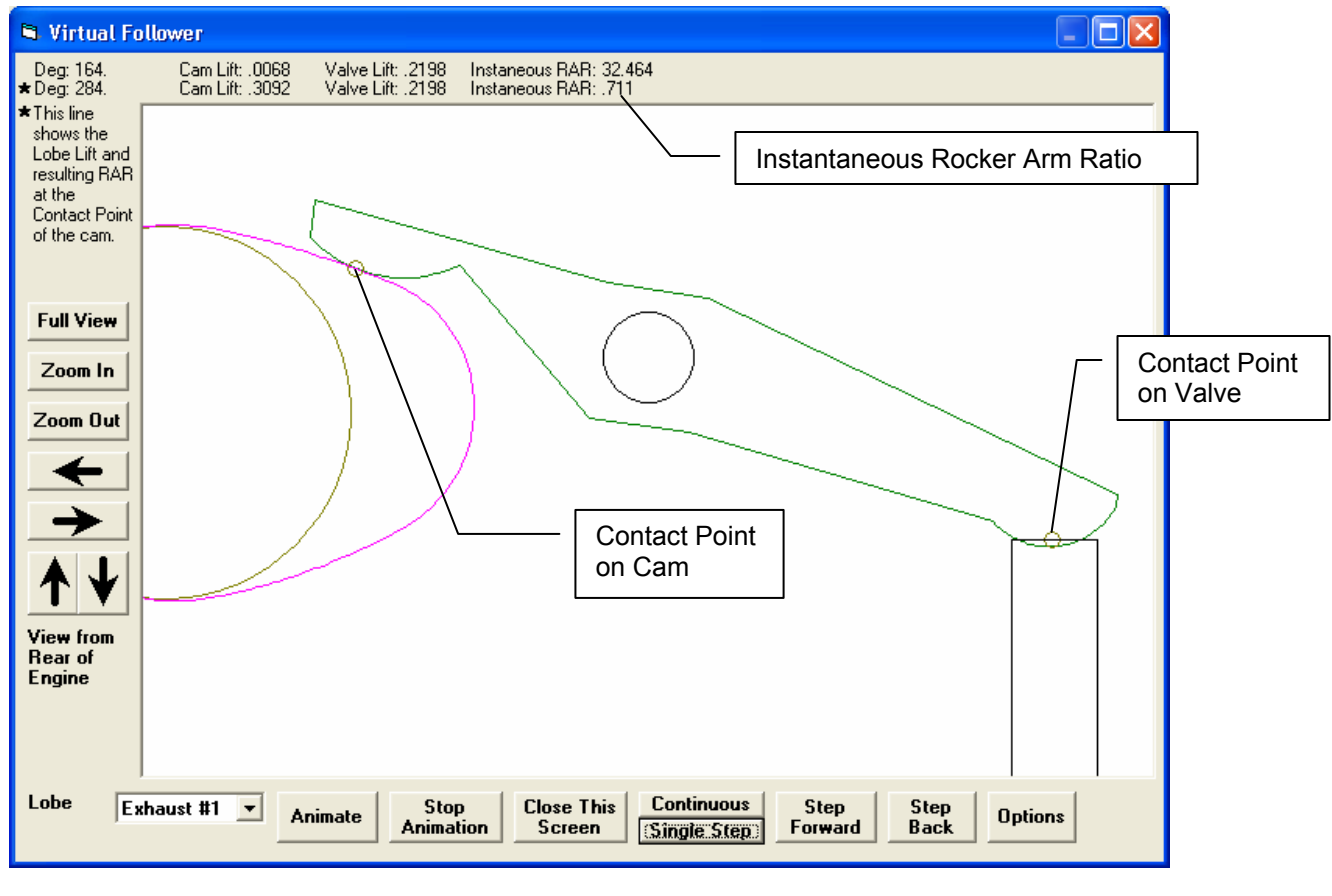

Figure A38 Cam Card Report

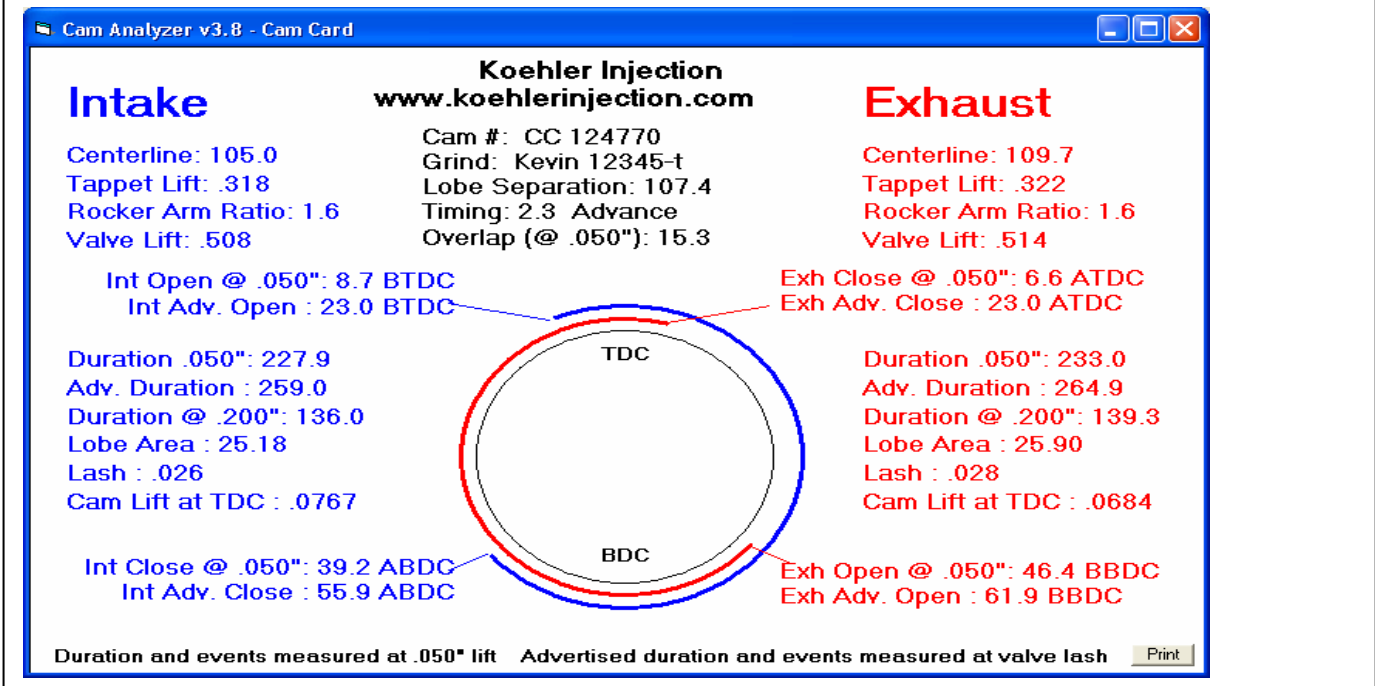

Figure A39 New Methods for Finding TDC and Indexing the Rotary Encoder

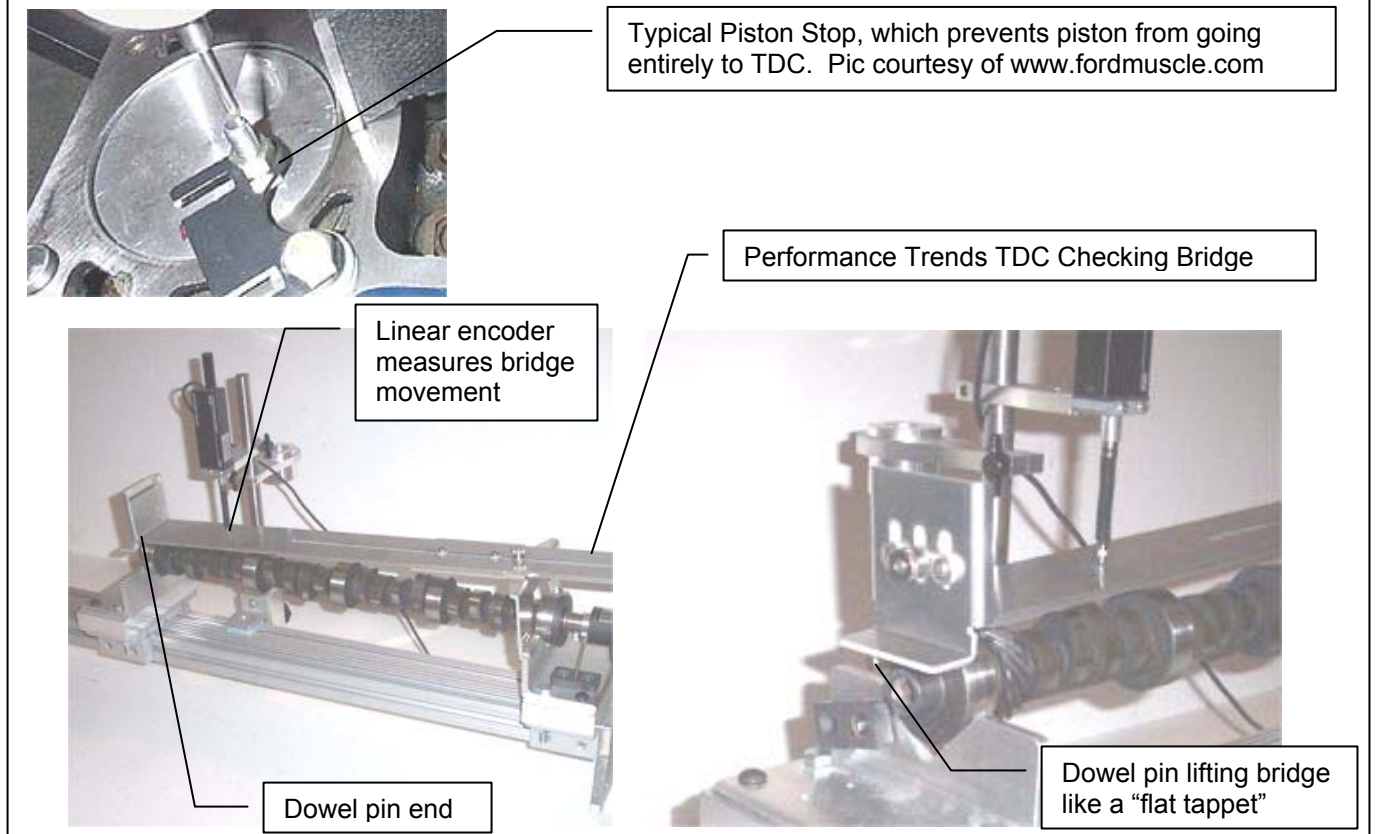

Figure A40 Dowel Pin or Keyway Location Input in Cam Design Layout Specs

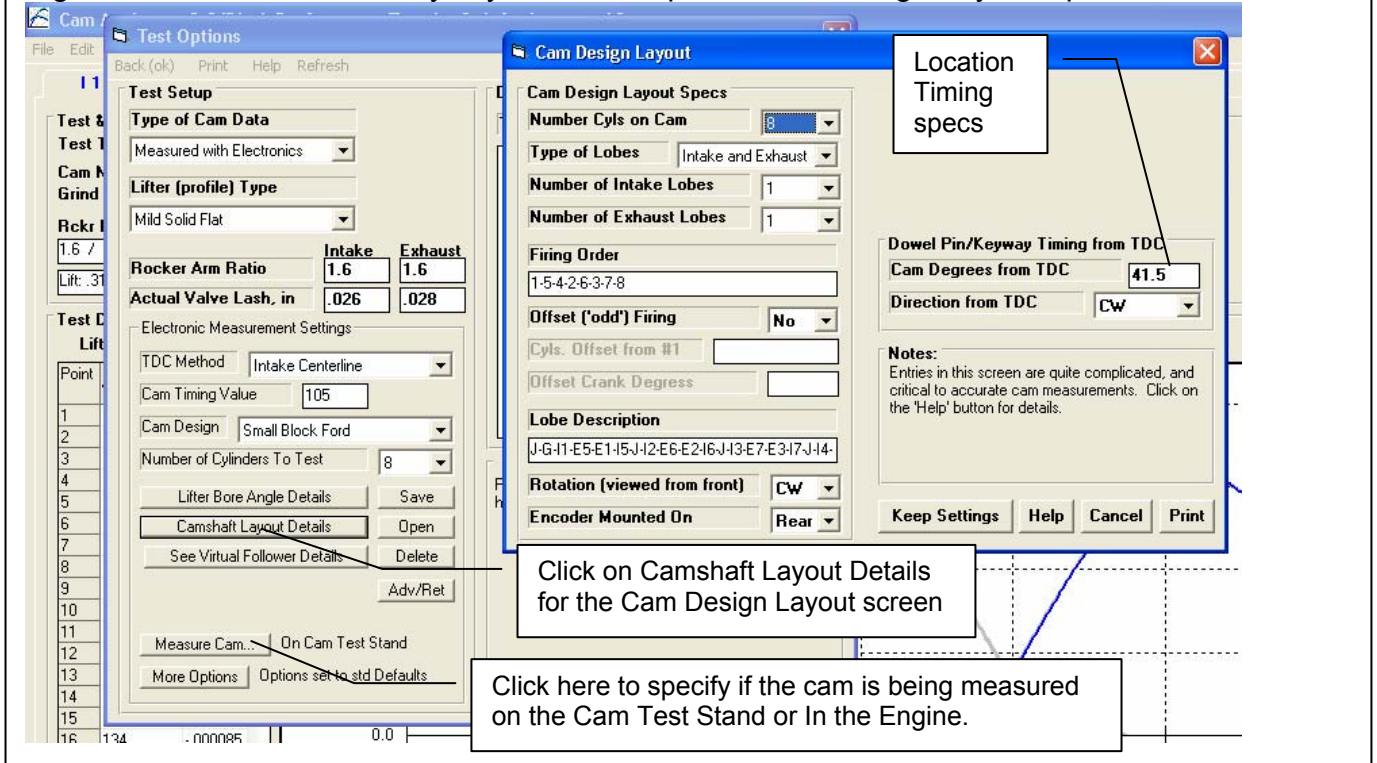

Figure A41 Example of More Cam Layout Choices, DOHC Exhaust 4 Cylinder Cam

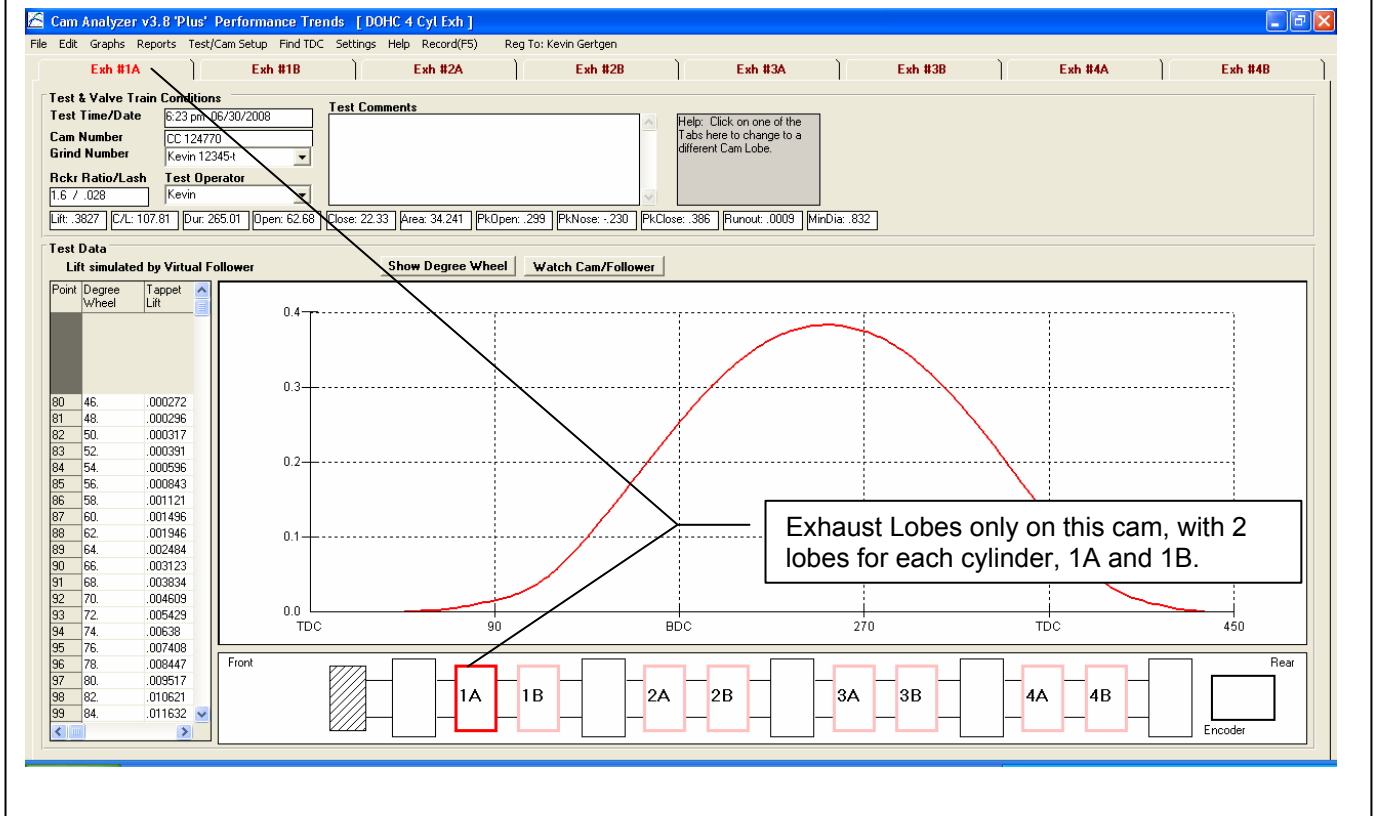
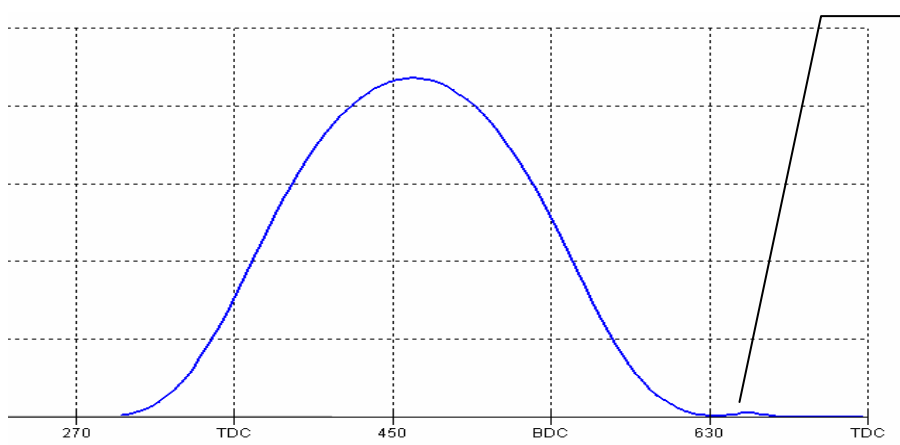

Figure A42 Advanced Options Required for Some Lobes



Second "lobe" or bump designed into cam profile. If you don't use some of the More (advanced) Options, this bump will be included in base circle runout and greatly distort the measured cam data.

In this situation, you want to select the "2 'bumps'" and "Zero Lift is Minimum Lift" options.

Preferences

General Operation | File Handling | OK

Emailing

Calculations | Calculations, cont. | Cancel

Graphing / Printing | **Electronics** | Help

Electronics

Auto Advance to Next Lobe: Yes

Next Lobe Is: Cam Lobe Position

Warn if Turning Cam Too Fast: Yes

Warn if High Accels Found: Yes

% Dif. from #1 Cyl to Flag Out: 5%

Show More Options in Setup: Yes

Restart Showing Help Tips

Don't Ask About Updating

You must turn on the "More Options" in Preferences for the button to appear in Test/Cam Setup.

Test/Cam Setup

Actual Valve Lash, in: .026 .028

Electronic Measurement Settings

TDC Method: Intake Centerline

Cam Timing Value: 105

Cam Design: Small Block Ford

Number of Cylinders To Test: 8

More Options

Options set to std Defaults

Set Options to Defaults

- Typical Cam Lobe (opens and closes once) - default
- Cam Lobe may have 2 "bumps" (may open and close twice)
- Just show data for Actual Lobe - default
- Show All data measured (all 400 deg)
- Zero Lift is Average Lift Measured on Base Circle - default
- Zero Lift is Lowest Lift Measured on Base Circle

Click on "More Options" button to allow select from these 3 Advanced Options.

Appendix 6: New Features in v4.0

Cam Analyzer has had many updates since this user manual was written for the original v2.0 for Windows. These include 3.2A (Appendix 3), 3.2B (Appendix 4), v3.8 (Appendix 5) and now v4.0 (Appendix 6). Here is a listing of some of the new features for Version 4.0:

Cam Analyzer v4.0 actually has 5 different versions now, which include:

- Cam Analyzer Basic (for analyzing cam data from either manual data entry or computer cam files)
- Cam Analyzer Plus (for more detailed analyzing of cam data from either manual data entry or computer cam files)
- Cam Analyzer Basic for use with the electronic Cam Test Stand (CTS) sensors
- Cam Analyzer Plus for use with the electronic Cam Test Stand sensors
- Cam Analyzer Plus for use with the electronic Cam Test Stand sensors, with advanced “Cam Grinder” features

Note that some of these new features apply only to the Plus Version and/or “Cam Grinder” version of the software. Also note that the “Cam Grinder” version contains all Plus Version features.

New Features for the “Cam Grinder” Version Only:

The Cam Grinder version of the program now allows you to measure each lobe and NOT adjust for lifter bore angles and firing order. Instead of all Intake and Exhaust lobes lining up on top of each other (except for manufacturing variations), the lobes fall out as they would as you look at the end of the cam. This is how most Cam Grinders prefer to see the results displayed. Fig A44B.

The Cam Grinder version of the program now allows you to measure the absolute lift of the lobes and bearings. This way you can get a picture of the cam as viewed from the end, with all lobes shown as they are ground on the cam. You also can see how the lobes compare to the journals and how the journals look compared to each other (cam bent). In doing this, the program first asks you to measure the journals lying on the V blocks, or first and last journal on cam if mounting the cam on centers. This you do with a dial indicator. Then the program steps you through a sequence of measurements on these journals on the stand. This way any slight slope of the cam on the stand is corrected for. After that, you must be careful to not adjust the height of the linear encoder as this will cause errors in height measurements. This way also allows the CTS (Cam Test Stand) to measure the base circle of each lobe. Figs A45, A46.

The Cam Grinder version of the program now allows you to pick various data types to graph and combine them on 1 graph. It also includes several new data types for graphing (Figs A47-52), like:

- Absolute Lift (This is lift measured from the center line of the cam. If you have a 1.100” diameter base circle and a .400” max tappet lift, you should see approximately .550” of lift on base circle and .950” (.550” + .400”) of lift at max lift.) Figs A47, A48, A49.
- Thrust Angle (For a roller cam, this is the angle the contact force is acting on the follower, typically putting some amount of side loading or thrust on the follower.)
- Contact Point (How far from center of the follower has the contact point moved.) Fig A50.
- Radius of Curvature (The radius of curvature at this particular point on the Actual Cam Profile.)
- Raw Cam Data as Measured (This is what the linear encoder measured.) Fig A49.
- Actual Cam Profile (This is what a “knife edge” pointer would have measured. This is the “Raw Cam Data as Measured” but correcting for the radius of the pointer which was doing the measurements. This should be what a cam grinder would have for a design file.) Fig A47.
- Lift Frequency Analysis *
- Acceleration Frequency Analysis (Fig A52). *
- Jerk Frequency Analysis *

* These Frequency Analysis graphs can be done either vs Order Number or RPM Based on the Natural Frequency of a valve spring. The specs for the Natural Frequency of the Valve Spring are contained in the Test/Cam Setup Screen. See Appendix 7 for more details on this Frequency Analysis, FFT Analysis.

The Cam Grinder version of the program now allows you to import X and Y data or Polar coordinates of degrees and radius to generate a cam profile. This is done by clicking on the Tappet Lift title column. Then the Edit Test Data screen opens up and there are new Advanced Import Features with several options. Figs A53, A54.

The Cam Grinder version of the program lets you enter valve spring info to estimate the spring's natural frequency. This allows Frequency Analysis graphs to be graphed vs Engine RPM rather frequency order number. Fig A52 and Appendix 7.

Program has an "Export Manufacturing Style Cam File". Two basic formats are currently available, P File and X,Y Data. Fig A55.

Program has an "Export Graph Data as File" option, so you can export any data you can graph as a comma separated text (ASCII) data file. If you click on this option, the program will ask for a file name. If you give it a .csv extension, it will open directly in Microsoft Excel. Fig A50.

Program has an Edit option of "Cut and Append". Say you have recorded 360 degrees of data (typical for a "Measured with Electronics" file), but the data starts right at the opening ramp. You would like to have the data start about 100 degrees before the opening ramp. You could use this command to take copy the last 100 data points and put them before the opening ramp. When done, it would appear that you started recording the data 100 deg earlier. (Typically this is only needed for fixing mistakes, or working with VERY unusual cams like the Ducati desmodromic cam.)

You can now select for a variable amount of Filtering (smoothing) the cam lift data when exporting cam files (None, Some, Medium, Heavy). (This is not allowed for cam files exporting "Raw" data.)

Major New Features for v4.0 Plus Version (also in Cam Grinder Version):

The program can now use most any radius pointer for measuring a cam for doing the Virtual Follower analysis. This means that you could measure a cam with the .750" diameter Universal Roller and then correct to what it would be with a .800", or .700" diameter roller. You can also correct to something really different, like the exact cam profile as ground, like you were measuring the cam with a "knife edge" pointer. An additional advantage of using a follower instead of the encoder probe directly is no side loading is put on the encoder probe, thus avoiding possible damage. Figs A44A, A56.

The Virtual Follower screen can now be enlarged for analysis in greater detail. Fig A56.

You now have 2 options for Analyze option at the graph screen: Just show 'the max difference between lobes, or show the difference between the lobes at all data points.

Now the program draws the actual profile lift (like the profile was measured with a "knife edge" pointer) on the Virtual Follower screen, in addition to follower lift. The program draws this in green and made the text boxes green which relate to this measurement. Fig A56.

Cam Card now has options for printing, printer setup, including a lobe from a different file for either an intake or exhaust lobe if the cam you are currently reporting has only Intake or Exhaust lobes, or including the Company Logo graphics file on the card. Fig A57.

Program now has a "Filtering" option to quickly find files fitting certain criteria. This would be like finding all files which have "CHEV" in the file name or the comments

Fig A44A Virtual Follower with Larger Follower

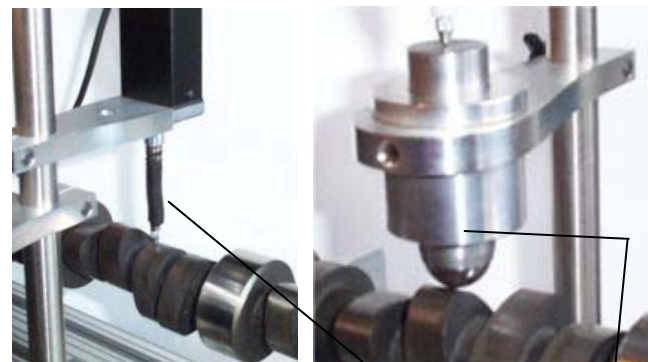

Previous versions required the encoder pointer directly on the cam lobe for doing Virtual Follower.

Now you can use larger diameter pointers (or actual roller followers) for measuring a cam and then simulating other follower diameters with Virtual Follower

section, or files having the number "346" in the Grind number recorded after a certain date, etc. Fig A56 and Appendix 8.
Seating Velocity report now includes option to estimate the lash point on cams. Fig A59.
The Custom Duration reports now have an option for including asymmetry.

Major New Features for v4.0 Std Version (also in Plus and Cam Grinder Versions):

New emailing options have been added in Preferences to work better with most any emailing system, like gmail, yahoo, etc. . Fig A60.

Program now has the ability to import just 1 lobe from a single lobe data file, like S96 or Comp Cams format into an existing Cam File. This allows you to build a cam consisting of and Intake and Exhaust lobe where the lobes can come from 2 different sources (different files and different file formats). Fig A91.

When opening files, a new option has been added of "List by Date File was Last Saved". This lets you more quickly find files you have recently changed or worked with.

Program will now allow direct conversion from most any type of data to 'Measured with Electronics' in a 2 step process. This conversion is necessary to allow you to do more advanced analysis of cam data.

Minor Changes/Bug Fixes for v4.0:

Added a Preference under the Calculations tab so you can change the lash the program assumes for doing Valve Lift, Acceleration, Velocity, etc graphs and reports. Note that the Cam Card always assumes .006 inches for doing Advertised duration and events.

You can now select 'Some' for 'Lift Filtering' for making a Graph or Report for most all cam files EXCEPT those Measured with Electronics or Created from Simple Specs. This was what was done prior to v4.0. Now you have an additional option of 'Some (including meas. w elec.)' so that you can do further smoothing of the recorded lift data. This can be especially useful when creating certain special graphs, like Simulating the Actual Cam Profile when it was measured with the pointer or a roller of a certain diameter.

Fixed bug where conversion to 'Measured by Hand' was not done correctly if you asked for it almost immediately after opening up the program.

Program now keeps ALL cam file data points imported from Cam Dr, Cam Pro Plus, etc for Plus or Cam Grinder versions. Limit for std version is still data points with .0015" lift or greater.

Program now correctly keeps cam Centerlines, Advance, etc when you import Cam Dr files when you ask to keep ALL timing events.

Printed graphs have been improved. Previously there could be a "broken" border on the left side.

Fixed some bugs where doing graphs where extra lobes could be included in a graph which were not requested.

Fixed a bug where a graph may not be updated correctly if you did not go back through the Graph Specs screen.

Program now does not do additional smoothing to lift curve if data is from a computer generated file. This is to save considerable calculation time.

Company Logo now appears on the main screen. Plus and "Cam Grinder" Version Only. Fig A44B.

Printouts have been refined to look better with various screen resolutions and operating systems.

The program now better imports certain data files which may have been stored in different units than what the program is set up for, inches vs mm.

Fixed bug where Intro Help Messages would cause the first graph open when starting program to possibly be bad.

Added more Cam Layout templates, 240/300 Ford 6 cylinder, 170/200 Ford 6 cylinder, 250/292 Chevy 6 cylinder.

The program now looks for lift points greater than 10 inches when reading in Cam Dr, Cam Pro Plus, etc cam files and edits them out. This can occasionally happen and is likely caused from the imported file being slightly corrupted, or being a slightly different version than we have encountered before.

Fixed a minor bug where the graph on the main screen may not completely show all lobes.

Fixed a bug where the graph screen could be significantly more narrow than what was available on the screen.

In the Plus and Cam Grinder versions, now you can Advance or Retard the cam degree wheel readings by up to 360 degrees under the Edit options. If you do this command more than once, you can advance or retard readings even more.

Figure A44B "Cam Grinder" Timing Option to show Absolute Timing of Lobes

The image shows two overlapping windows from the Cam Analyzer software. The 'Preferences' window on the left has the 'Electronics' tab selected, with 'Auto Advance to Next Lobe' set to 'Yes' and 'Show More Options in Setup' set to 'Yes'. The 'Test Options' window on the right shows 'Type of Cam Data' as 'Measured with Electronics' and 'Lifter (profile) Type' as 'Mild Solid Flat'. Under 'Electronic Measurement Settings', 'TDC Method' is 'Intake Centerline' and 'Cam Timing Value' is '110'. The 'Degree Wheel' shows a circular scale from 0 to 315 degrees. A 'Help' box is open, showing options like 'Typical Cam Lobe (opens and closes once) - default' and 'Cam Grinder Timing'.

You must first turn on this Preference to see options shown to the right. This is to prevent mistakes and unusual results which are possible if you don't understand these options.

Cam Grinder timing is shown below. "Typical" timing is when all intake and exhaust lobes lie on top of each other.

Choose this option to measure Absolute Lift (base circle) and journal diameters. Fig A45 shows procedure to measure Absolute Lift and Journal Diameters.

The main software interface displays 'Test & Valve Train Conditions' with fields for 'Test Time/Date', 'Cam Number', 'Grind Number', 'Rckr Ratio/Lash', and 'Test Operator'. Below this is a 'Test Data' table with columns for 'Point', 'Degree Wheel', and 'Tappet Lift'. The main graph area shows 'Lift simulated by Virtual Follower' with a 'Show Degree Wheel' button. The graph plots lift (0 to 0.4) against degree wheel (180 to 540). A blue curve highlights a specific lobe. Below the graph is a firing order diagram with cylinders 1-8 and journals J1-J5. A red logo 'Your Logo Goes Here' is overlaid on the interface.

Company Logo on Main Screen

Graph produced when data is graphed without correcting for lifter bore angles or firing order.

Figure A45 Procedure to Measure Absolute Lift of Lobes and Journals

Linear Encoder is Ready, Continue with Measurements?

?

You have selected to measure Journal Diameters and Lobe Base Circles with this cam.

To do this accurately, once you start a test you must NOT adjust the linear encoder other than sliding it from lobe to lobe, journal to journal, etc.

You must also have precisely measured the diameter of the first and last journal on the cam with a micrometer. You will measure the journal vertically (from top to bottom) with the lobe for I 1 on this cam pointing straight up.

Be sure the linear encoder can retract far enough to clear all lobes and journals, and extend far enough to reach the lowest base circles before starting any measurements.

Do you want to continue with measurements?

Yes No

Cam Analyzer

The program will now ask you to measure some points on the journals. This will be used to index (calibrate) the linear encoder.

After doing this, it is CRITICAL you do NOT stop testing or adjust the linear encoder until you have completed all measurements.

OK

If you choose to Measure Absolute Lift, and you go to measure the cam, the program will prompt you as shown here. The program will need to know the diameter of the first and last journal on the cam, measured precisely with a micrometer. Then the program can index the linear encoder and correct for any angle on the cam mounting on the stand.

J1 Diameter?

Enter the diameter measured for J1

Enter a value from .1 to 100.

OK Cancel

.985

J5 Diameter?

Enter the diameter measured for J5

Enter a value from .1 to 100.

OK Cancel

1.100

Cam Analyzer

With Lobe 1 pointing down, place linear encoder on Journal #1.

Click on OK to clear this message. Then press <F1> when you want the program to read this first journal.

OK

Perf Trends Readings: Intake 1 F9>

Close Record (F4) Options Help

Lift -.612243	Rotation 287.21	Time .000
-------------------------	---------------------------	---------------------

Intake 1

Updating Display Only (not recording). Press <F1> with lifter on base circle to start a test.

Not all steps are shown here. Follow them as outlined by the program. Note that you must follow the instruction on the message, then click on OK, and then Press <F1> for the program to record the linear encoder and rotary encoder.

This procedure is continued in Figure A46

Cam Analyzer

Rotate cam 180 degrees so Lobe 1 is pointing up.

Click on OK to clear this message. Then press <F1> when you want the program to read this first journal.

OK

Figure A46 Procedure to Measure Absolute Lift of Lobes and Journals, cont.

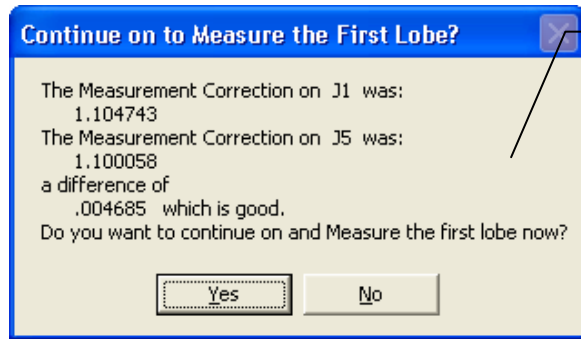

Once the measurements are made of the journals, the program analyzes them to determine the amount of slope (slant, angle) on the cam. In this case the center of Journal 1 (J1) was .004685 higher than the center of Journal 5 (J5). This slope is now used for all lobes and journals on the cam based on the relative position of the other journals and lobes are from J1 and J5. Because some assumptions are made, it is best if this slope is minimal.

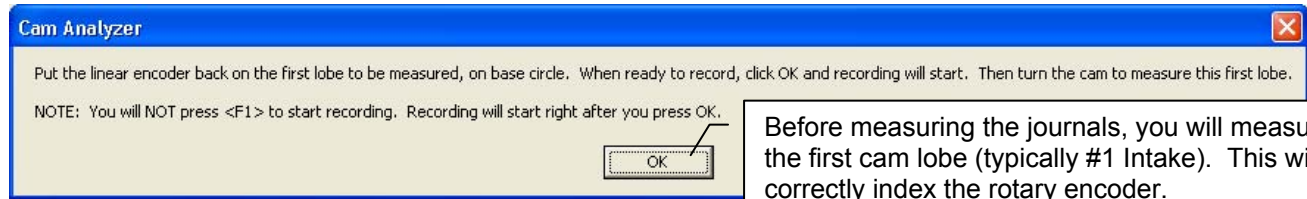

Before measuring the journals, you will measure the first cam lobe (typically #1 Intake). This will correctly index the rotary encoder.

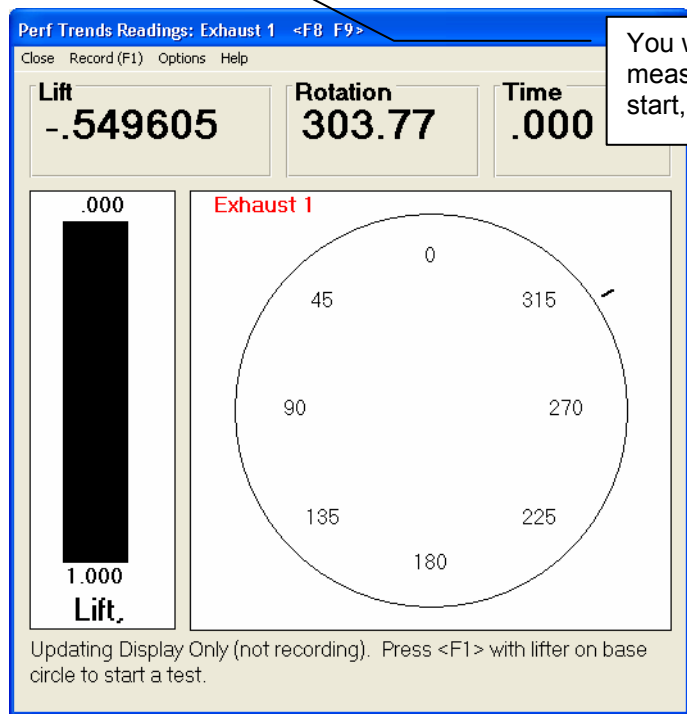
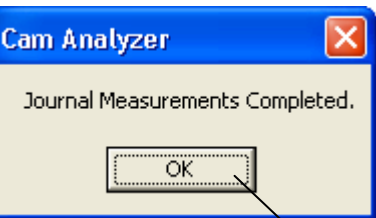
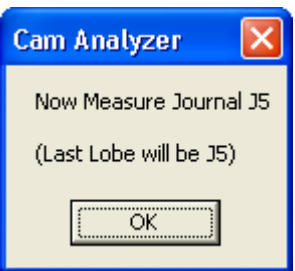
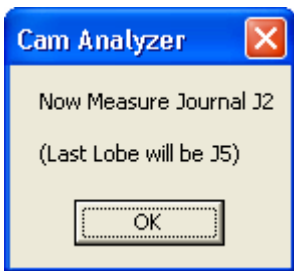
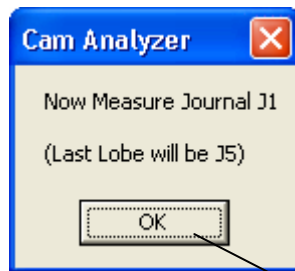

You will measure journals just like measuring a lobe, by pressing <F1> to start, then turning the cam 400+ degrees.

Not all steps are shown here.
Once the Journal Measurements are complete, the program will direct you to go on to measuring the remaining lobes on the cam, shown here as #1 Exhaust.
You will notice that both the linear and rotary encoders are indexed in this procedure. It is critical that neither of these encoders slip or are adjusted during this entire process.

Figure A47 New "Cam Grinder" Graph Options and Graph Data

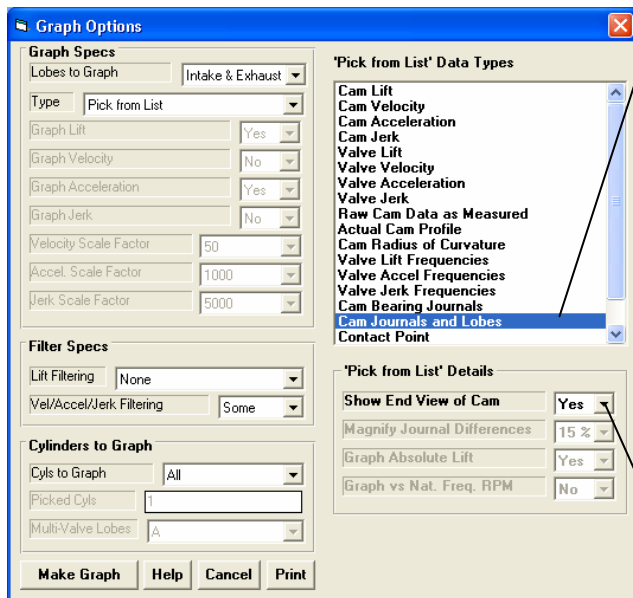

Some graph types are only available if the cam was "Measure Absolute Lift of Lobes and Journals", like this one "Cam Journals and Lobes". This special Data Type choice will graph the "Actual Cam Profile" data type with the actual journal "lift" (journal radius).

NOTE: Even if the cam was not measured this way, the data types are still listed here. If you select those data types or options, the program can produce unusual results or warning messages. The results will be SO obviously unusual, that you will definitely realize there is a problem.

Depending on your choice of Data Types from the list, some of the "Details" options will be enabled here.

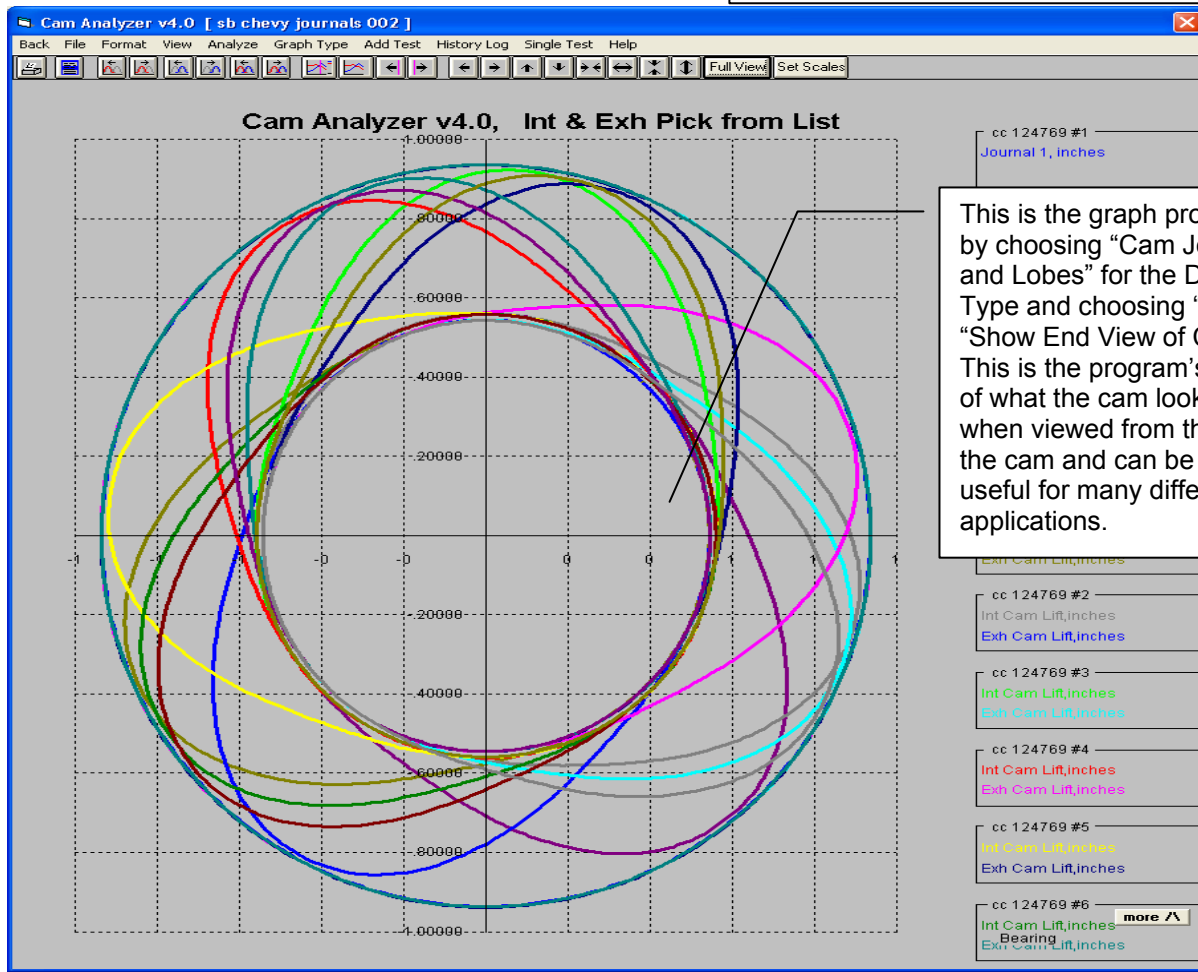

This is the graph produced by choosing "Cam Journals and Lobes" for the Data Type and choosing "Yes" for "Show End View of Cam". This is the program's picture of what the cam looks like when viewed from the end of the cam and can be very useful for many different applications.

Figure A48 New “Cam Grinder” Graph Options and Graph Data, cont.

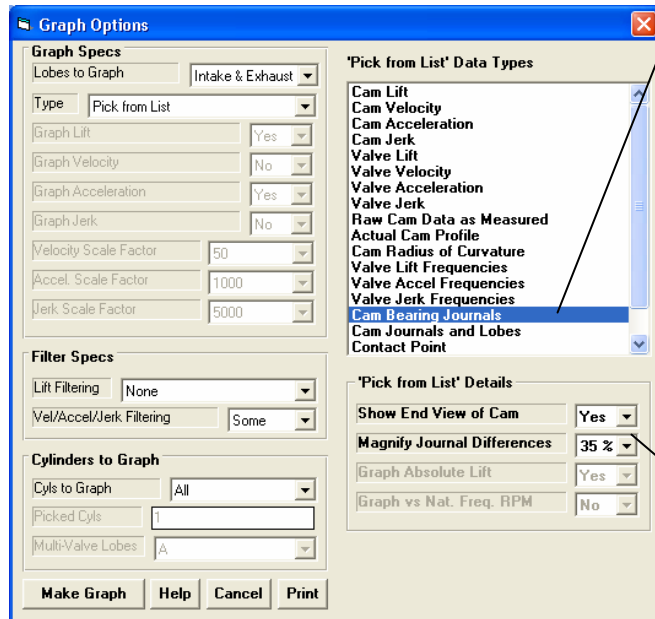

Some graph types are only available if the cam was “Measure Absolute Lift of Lobes and Journals”, like this one “Cam Bearing Journals”.

NOTE: Even if the cam was not measured this way, the data types are still listed here. If you select those data types or options, the program can produce unusual results or warning messages. The results will be SO obviously unusual, that you will definitely realize there is a problem.

Depending on your choice of Data Types from the list, some of the “Details” options will be enabled here. For this Data Type, there are 2.

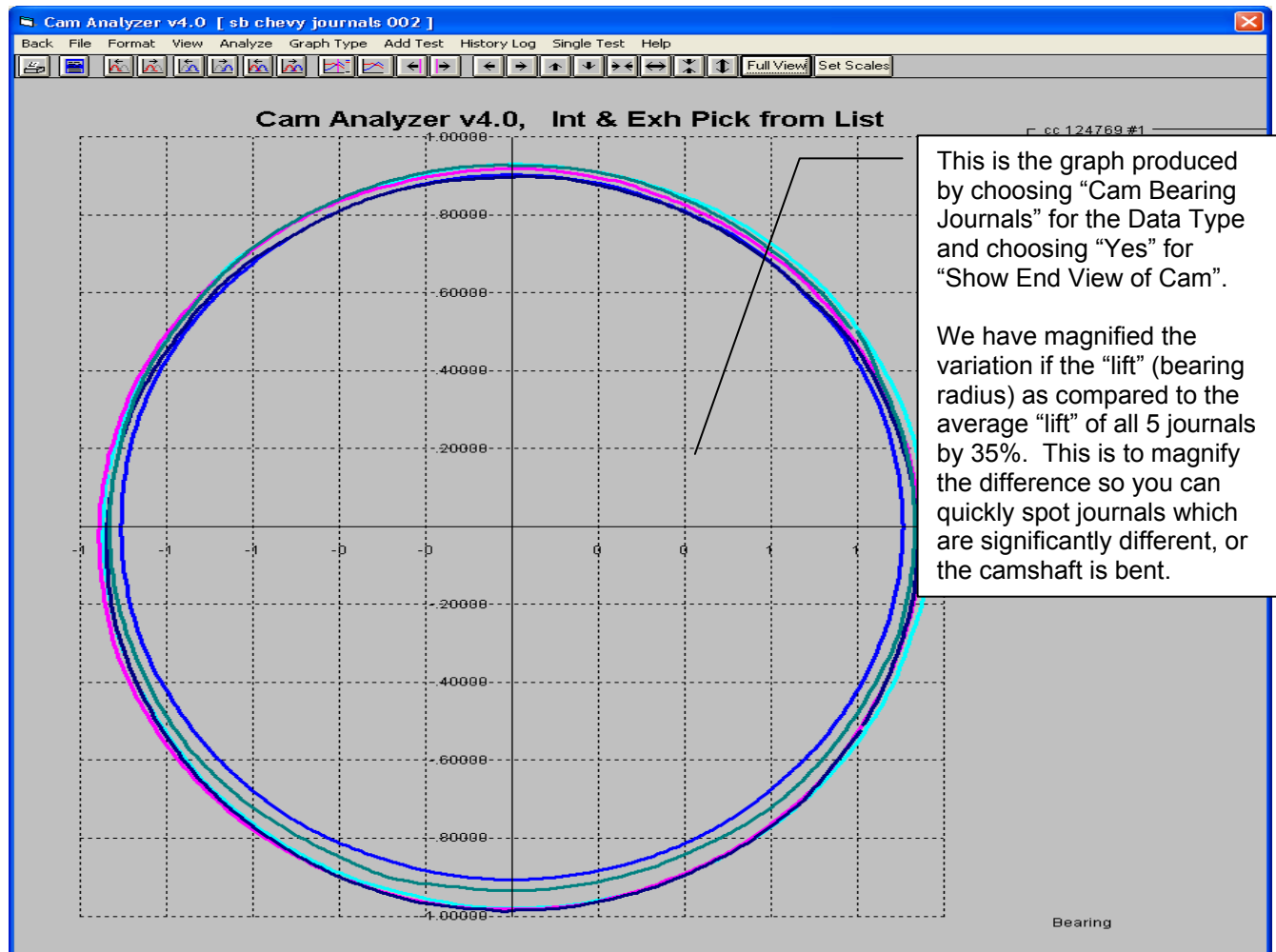
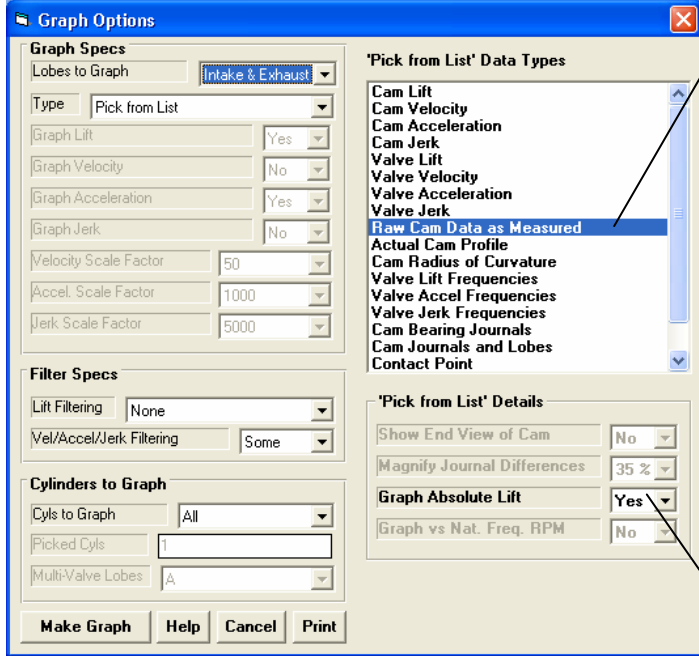

Figure A49 New “Cam Grinder” Graph Options and Graph Data, cont



This is the “Raw” lift data as measured by the linear encoder. If you are measuring a cam with the proper profile follower, this is also the Cam Lift. However, if you are measuring with various radius pointers and doing Virtual Follower, this “Raw Cam Data as Measured” is not representative of any type of lift this cam will produce in the engine. This data will have to be either converted to “Actual Cam Profile” data (as if the cam was measured with a knife edge pointer), or Cam Lift (converted via Virtual Follower to what the follower would do), or Valve Lift (what the valve will do based on Cam Lift, lash or assumed hydraulic lash, and rocker arm ratio).

This option will only make sense if the cam was “Measure Absolute Lift of Lobes and Journals”.

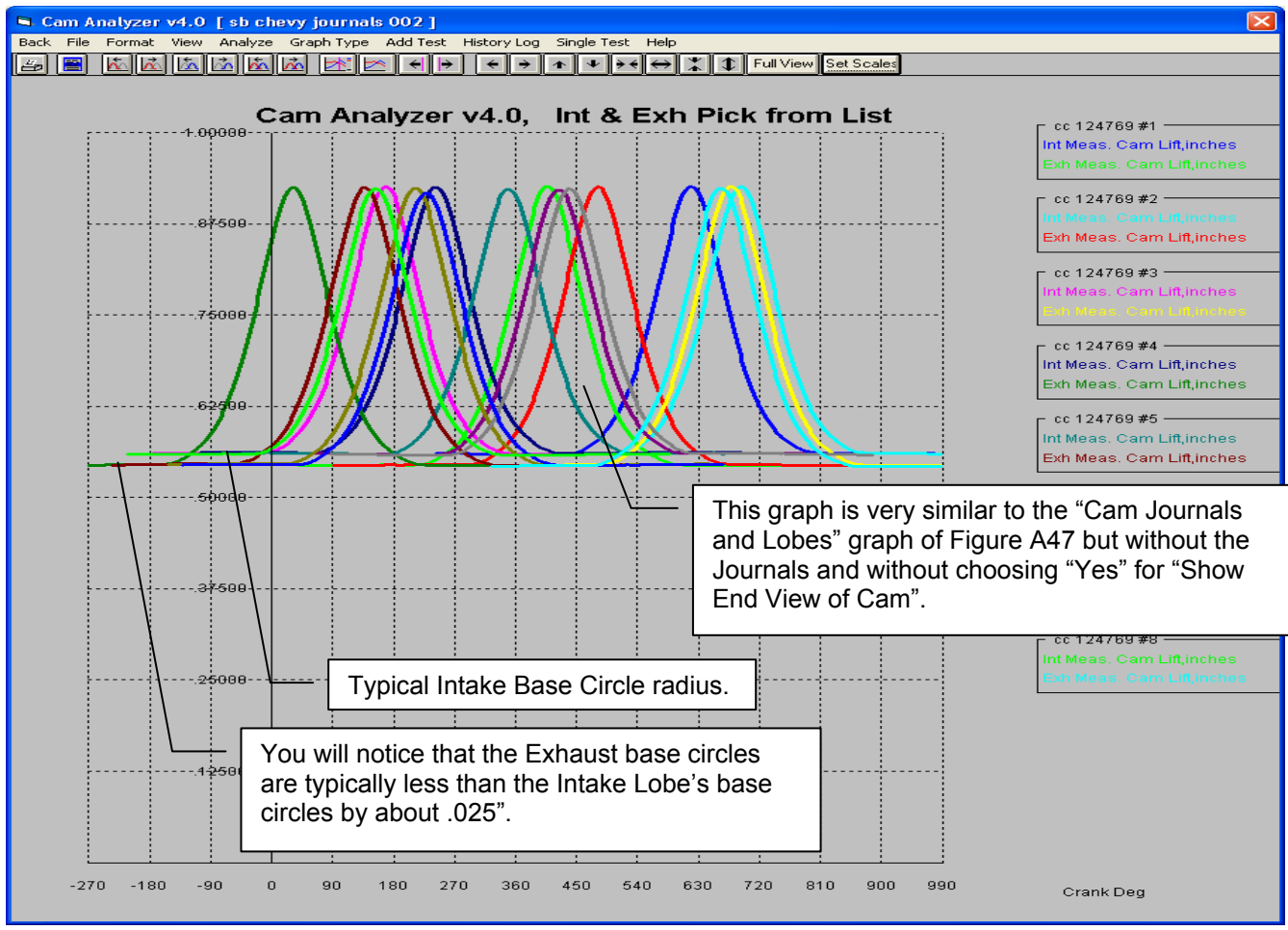
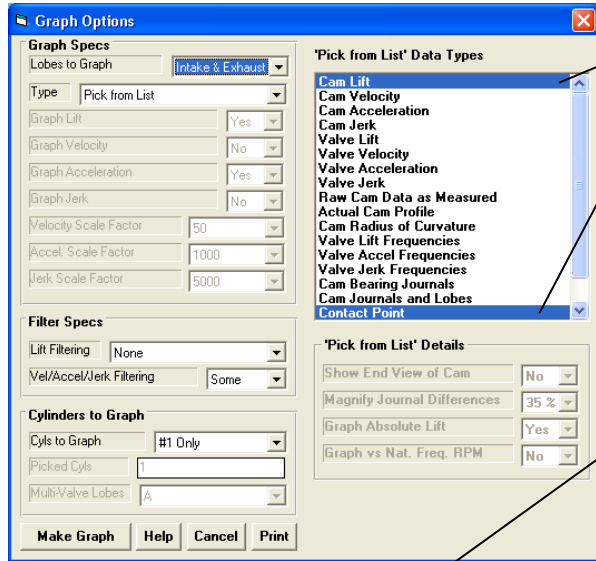
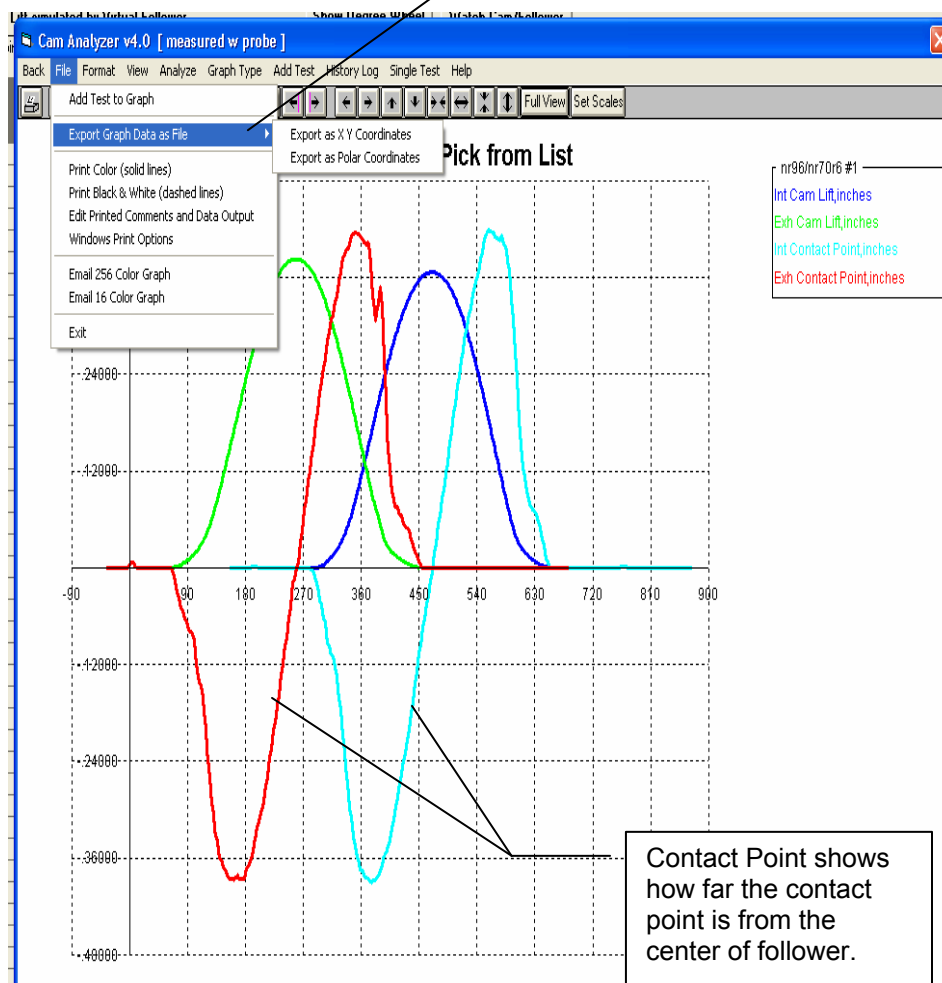

Figure A50 New “Cam Grinder” Graph Options and Graph Data, cont.



Example of producing a graph with 2 very different types of data on the same graph, Cam Lift and Contact Point.

“Cam Grinder” Only option of exporting any graph data as a comma separated data file. If you give the file name a “.csv” extension, the file will open directly in Excel (outside the Cam Analyzer program).



Contact Point shows how far the contact point is from the center of follower.

	A	B	C	D
1	Int Cam Li	Int Cam Li	Exh Cam L	Exh
2	280	0	60	0
3	280	0	60	0
4	280	0	60	0
5	280	0	60	0
6	280	0	60	0
7	280	0	60	0
8	280	0	60	0
9	280	0	60	0
10	280	0	60	0
11	280	0	60	0
12	280	0	60	0
13	280	0	60	0
14	280	0	60	0
15	280	0	60	0

Figure A51 New “Cam Grinder” Graph Options and Graph Data, cont.

Choose “Pick from List” and 2 types of “Cam” data to produce the graph below.

Or, you can pick “Cam Data” as the type and the 2 data types (Lift and Velocity) and produce the same results as the setup shown to the left.

This is the method available in previous versions before v4.0 or in the Std. and Plus versions.

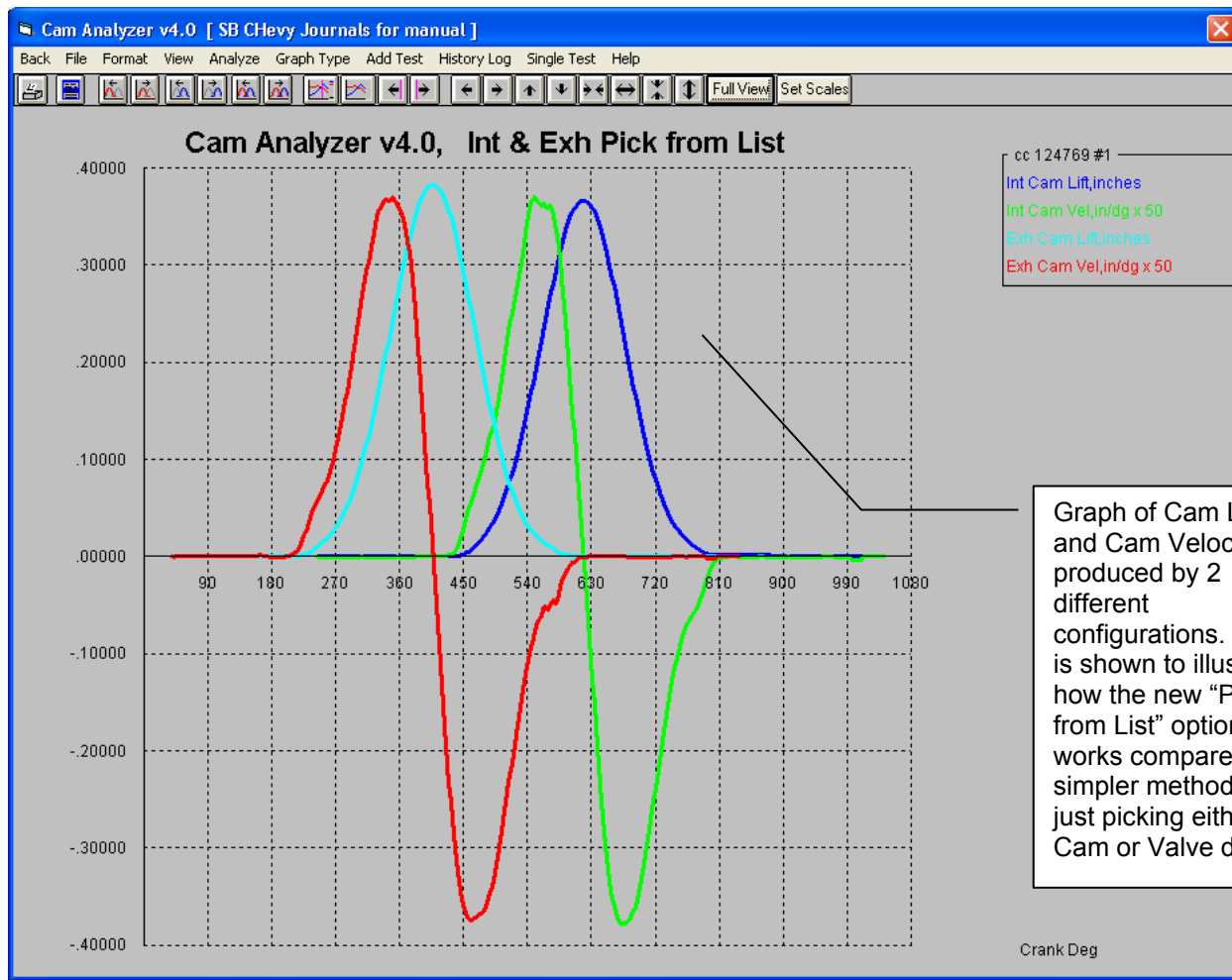

Figure A52 "Cam Grinder" FFT Analysis (also Fig A62)

Click here to bring up Primary Valve Spring Specs Screen

Calculated spring data including natural frequency

Choose Valve Accel Frequencies to produce the graph below. Lift and Jerk Frequencies produce similar graphs, but limiting values are not known.

2 Methods to obtain springs natural frequency

Your choice here determines which limit is drawn on the Valve Acceleration FFT graph

Primary Valve Spring

Natural Frequency, Hz	390.1
Natural Frequency, CPM	23404
Spring Rate, lb/in	388.41
Est Spring Weight, gms	111.8
Bind Height, in	.816

Primary Spring Data

Enter Freq Directly? No

Wire Diameter, in .204

Coil Outside Diameter, in 1.68

Total # Coils 6

Active # Coils 2

Valve Train Pushrod w/ Rocker Arr

Graph Options

Graph Specs

Type Pick from List

Graph Velocity Yes

Graph Acceleration No

Graph Jerk No

Velocity Scale Factor 50

Accel. Scale Factor 1000

Jerk. Scale Factor 5000

Filter Specs

Lift Filtering None

Vel/Accel/Jerk Filtering Some

Cylinders to Graph

Cycle to Graph #1 Only

Picked Cycle 1

Multi-Valve Lobes A

'Pick from List' Data Types

- Cam Lift
- Cam Velocity
- Cam Acceleration
- Cam Jerk
- Valve Lift
- Valve Velocity
- Valve Acceleration
- Valve Jerk
- Raw Cam Data as Measured
- Actual Cam Profile
- Cam Radius of Curvature
- Valve Lift Frequencies
- Valve Accel Frequencies
- Valve Jerk Frequencies
- Cam Bearing Journals
- Cam Journals and Lobes
- Contact Point

'Pick from List' Details

Show End View of Cam No

Magnify Journal Differences 35%

Graph Absolute Lift Yes

Graph vs Nat. Freq. RPM Yes

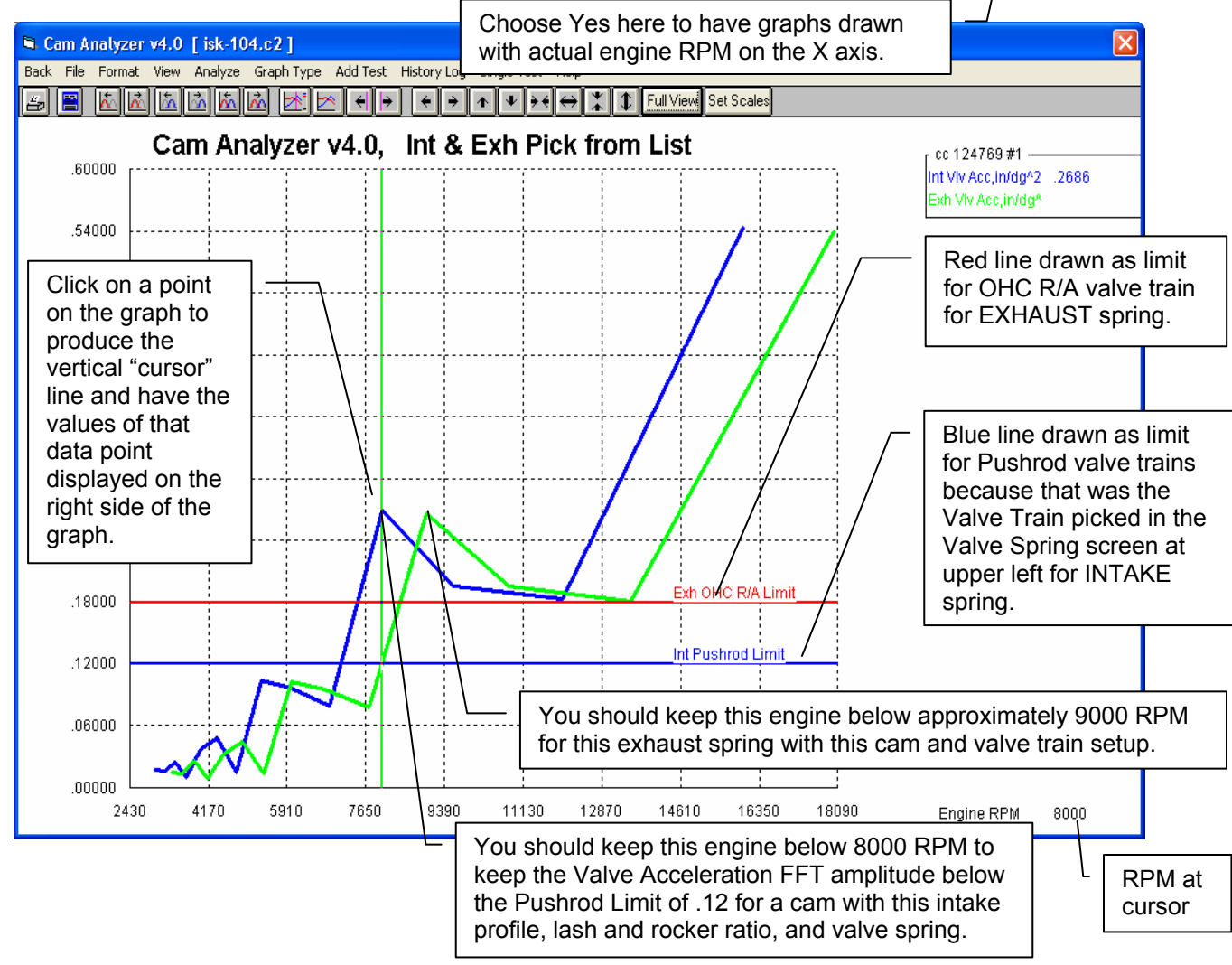
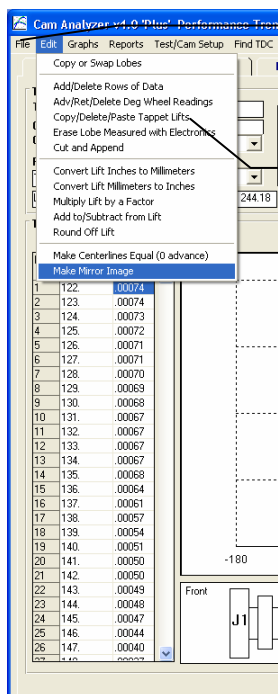

Figure A53 New "Cam Grinder" Edit Feature to Copy X/Y or Deg/Lift Data



This figure shows how you can edit an existing data file. You can also "edit" a NEW file which was created by clicking on "File", then one of the "New" options.

The "Copy/Delete/Paste Tappet Lifts" edit option is very powerful. If you click on it, you may be given the warning message below.

The only "Type of Cam Data" which can be manually edited is "Measured by Hand". This particular cam file is currently shown as "Type of Cam Data" as "Measured with Electronics". Therefore a conversion must be made before it can be edited.

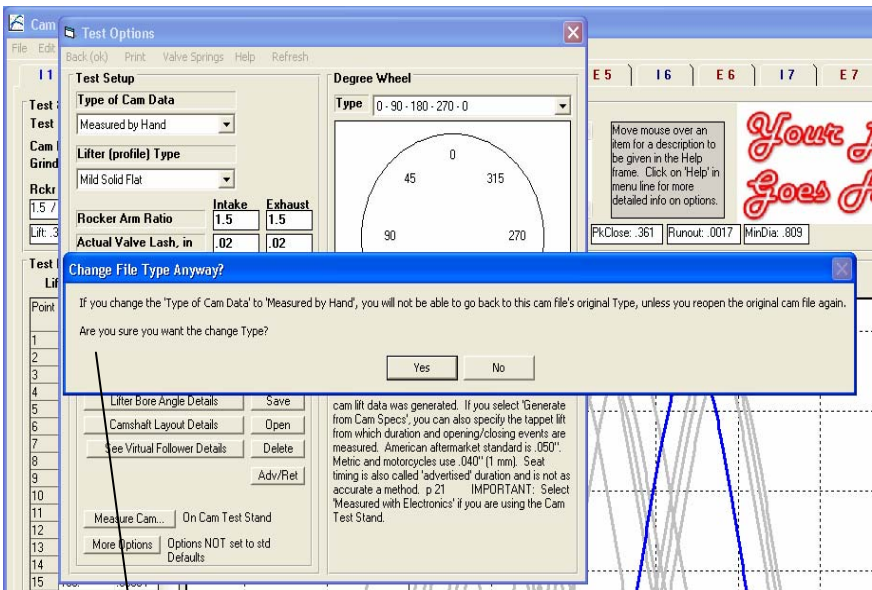
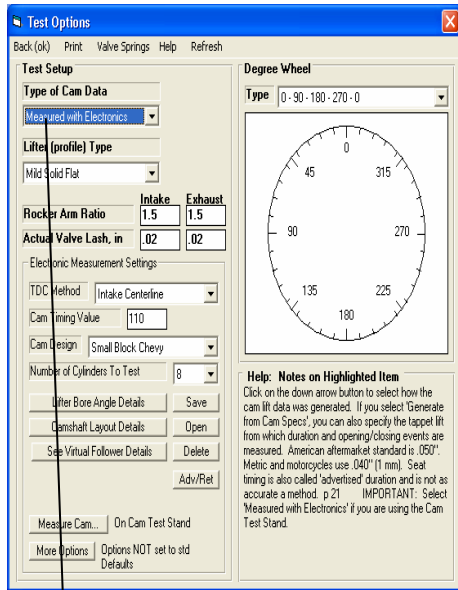
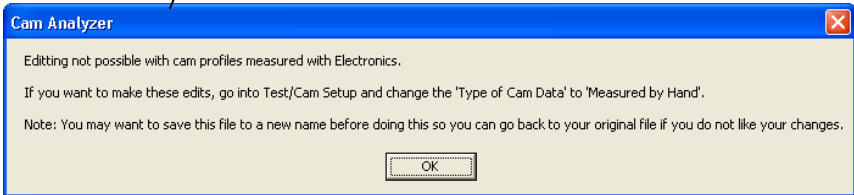

If you click on Test Options at the top of the main screen, this Test Options screen shows the "Type of Cam Data" is "Measured with Electronics". Click on this drop down and choose "Measured by Hand" as shown in the lower left corner.

Once you do this, the program will show the message to the upper right, and you will have to confirm you really want to make this change. To be safe, you may want to save your file to a different name first (File, then Save As) so you can return to your data before you make this significant change.

Figure A54 New "Cam Grinder" Edit Feature to Copy X/Y or Deg/Lift Data, cont

You can copy 2 columns of X/Y data from Excel by highlighting the columns and using the Ctrl-C (copy) command.

Choose from these Advanced "Cam Grinder" features to describe the data you've pasted into the edit field.

Click on the Tappet Lift title of this column and the Edit options will appear. The Cam Grinder version has several additional features as shown here.

Click in this field and do the Ctrl-V (paste) command to paste the X/Y data from Excel into this field.

Once the data is pasted and the Advanced Import Features are set, click here to do the actual import.

Once imported, you may have to do additional Edit options to advance or retard the profile to adjust timing.

Point	Degree Wheel	Tappet Lift
1	244	02
2	246	02
3	248	02
4	250	02
5	252	02
6	254	02
7	256	02
8	258	02
9	260	02

Figure A55 New "Cam Grinder" Export Manufacturing File Feature

Choose the "Export Manufacturing Style Cam File" for the screen of options to the right.

Choose from the various Formats available. The X,Y Data formats also let you pick the "Separator".

Click Browse button if you want, to pick a folder as shown to the right.

Browse to a folder, then click OK to close this list.

Click Make File to make the file shown to the right

360 lines of X, Y data opened up in Notepad

```

-3157741, .4862514
-3242123, .4806663
-3325516, .4749348
-3408997, .4690587
-3489240, .4630396
-3569520, .4568796
-3648713, .4505803
-3726795, .4441438
-3803741, .4375720
-3879528, .4308669
-3954134, .4240306
-4027535, .4170651
-4099709, .4099726
-4170635, .4027552
  
```

Figure A56 New Virtual Follower Features

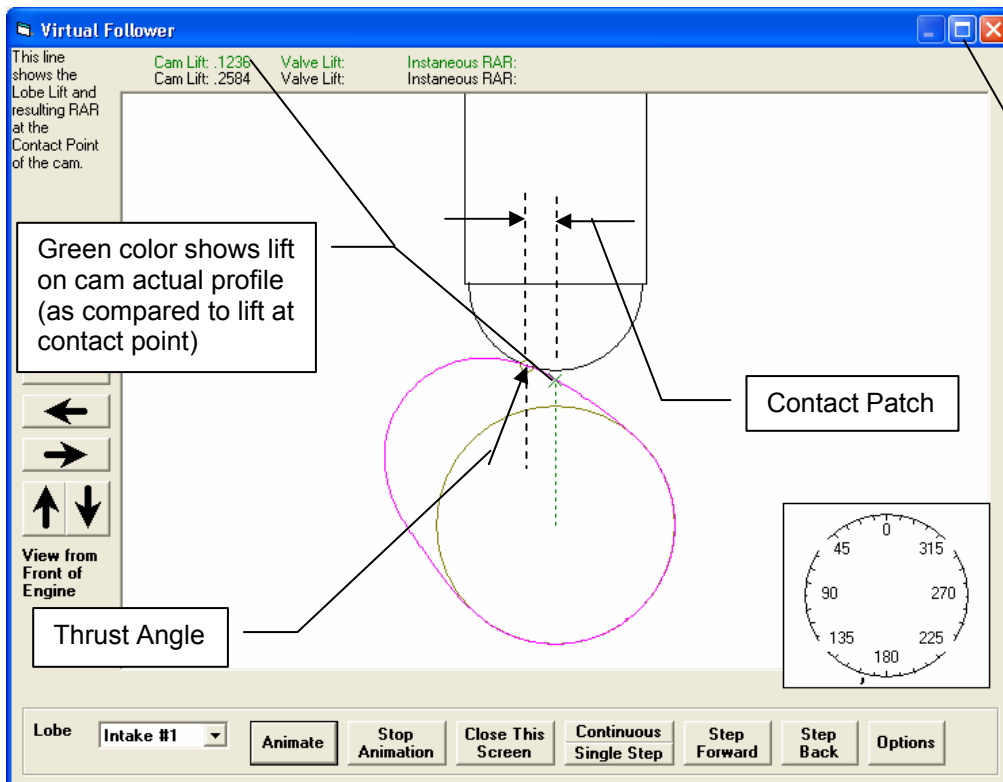
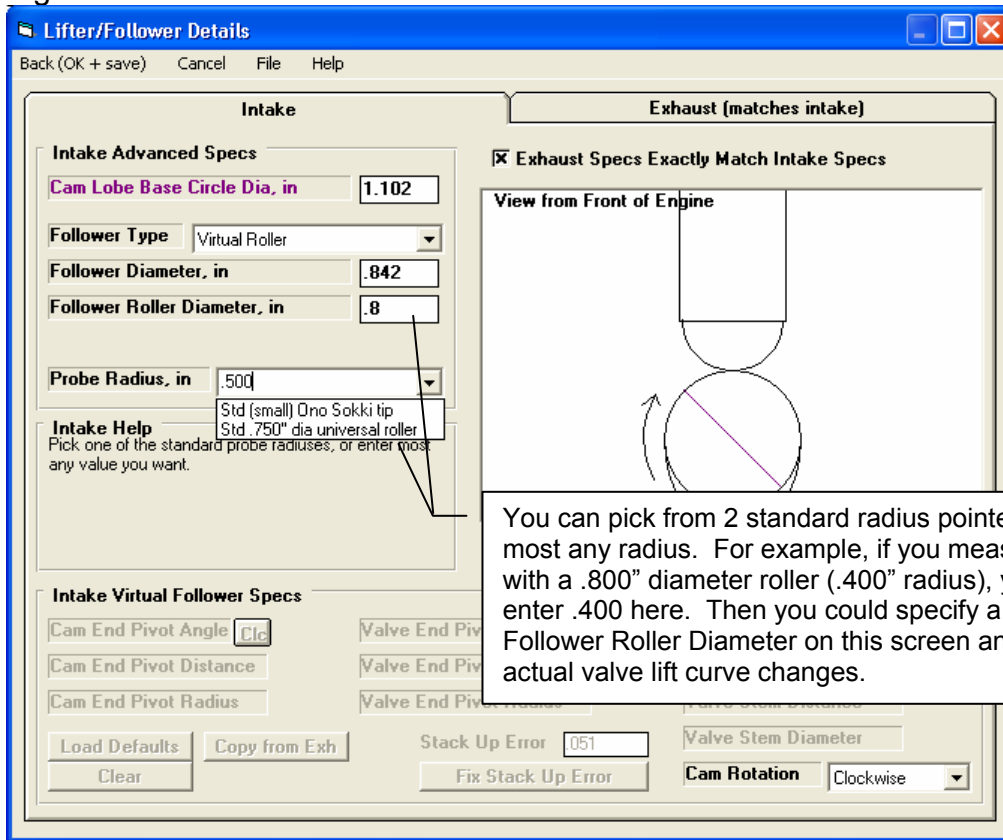

You can now resize or Maximize this screen to take advantage of screens with high resolution.

Figure A57 New Cam Card Features

Cam Card with both the Program Title text and the Company Logo graphics file (both loaded in the Preferences screen).

Click Options button for these options.

Click here to browse your computer to pick a Cam Analyzer file with the Exhaust cam profile.

Note showing Exhaust Lobe data is from a different Associated File "3 lobes exh".

You will notice on the main screen behind the Cam Card, there is only Intake data. The exhaust data shown here is from the Associated File "3 lobes exh" file, as shown in the lower left of the Cam Card.

Options for including text and/or the Company Logo

Intake

Centerline: 129.2
Tappet Lift: .336
Rocker Arm Ratio: 1
Valve Lift: .336

Int Open @ .050": -30.5 BTDC
Int Adv. Open : 7.9 BTDC

Duration .050": 197.4
Adv. Duration : 275.4
Duration @ .200": 129.3
Lobe Area : 23.98
Lash : .01
Cam Lift at TDC : .0124

Int Close @ .050": 47.9 ABDC
Int Adv. Close : 87.5 ABDC

Intake Lobe: A Exhaust Lobe: A (from file: 3 lobes exh)
Duration and events measured at .050" lift Adversed duration and events measured at valve lash

Exhaust

Centerline: 107.0
Tappet Lift: 6.021
Rocker Arm Ratio: 1.6
Valve Lift: 9.634

Exh Close @ .050": 3.7 ATDC
Exh Adv. Close : 23.8 ATDC

Duration .050": 201.1
Adv. Duration : 241.5
Duration @ .200": 261.5
Lobe Area : 440.29
Lash : .46
Cam Lift at TDC : 1.2020

Exh Open @ .050": 17.4 BBDC
Exh Adv. Open : 37.8 BBDC

Options menu:
Load an Associated File for Another Lobe
Company Logo
Print
Windows Printer Setup
Close this Screen
Text Only
Logo Only
Logo and Text

Encoder

Figure A58 New File Filtering Features

This Filtering feature is discussed in more detail in Appendix 7.

Open Test File

Chosen File: SB CHEvy Journals for manual

9 Tests fit Filter Specs

- 6/8/2012 SB CHEvy Journals for manual edit
- 6/8/2012 SB CHEvy Journals for manual 001
- 6/8/2012 SB CHEvy Journals for manual
- 11/29/2011 SB CHEvy Journals 002
- 11/22/2011 SB CHEvy Journals 001
- 11/22/2011 SB CHEvy Journals
- 11/6/2011 bb chevy meas journals 003
- 11/6/2011 BB Chevy meas journals 002
- 10/23/2011 BB Chevy meas journals 002 - Copy

Trying lobes and journals on SB Chevy cam

Filter (find)

If files are being "filtered" (only certain files shown which fit your criteria), it is shown here and here in blue.

Filtered File List

Test	Folder
Journal Test 002	Artman
Journal Test 003	Artman
Journal Test 001	Combine Int and Exh Fil
BB Chevy meas journals 002	Measure Journals
BB Chevy meas journals 002 -	Measure Journals
bb chevy meas journals 003	Measure Journals
SB CHEvy Journals	Measure Journals
SB CHEvy Journals 001	Measure Journals
SB CHEvy Journals 002	Measure Journals
SB CHEvy Journals for manual	Measure Journals
SB CHEvy Journals for manual	Measure Journals
SB CHEvy Journals for manual	Measure Journals

Print Cancel

If you click "Filter (find)" you will be presented with the screens shown below.

Filter Files

List Files If ...

This comment or spec: File Name Has this relationship: Contains To what I entered here: jour

List Files If ...

This comment or spec: Test Comments Has this relationship: Contains To what I entered here: []

List Files If ...

This comment or spec: Operator Has this relationship: Contains To what I entered here: []

Show only files fitting these limits

Print list of all files fitting these limits

Search All Folders

- Dana
- Dana from Lap Top
- Darryl Woods
- DEVRIES
- Dubose

Cancel Help

If you set "File Name" to "Contains" "jour", and check "Search All Folders" and click the button "Print list of all files fitting these limits", you will obtain the screen shown above. This is a list of all files stored folders in the CAMDATA folder which contain the phrase "jour" in the file name.

Filter Files

List Files If ...

This comment or spec: File Name Has this relationship: Contains To what I entered here: jour

List Files If ...

This comment or spec: Test Comments Has this relationship: Contains To what I entered here: bent

List Files If ...

This comment or spec: Operator Has this relationship: Contains To what I entered here: Jeff

Show only files fitting these limits

Print list of all files fitting these limits

Search All Folders

- aillo
- Artman
- Baker Briggs
- barnard
- BB Ford on Stand

Cancel Help

These settings will find all files which contain the phrase "jour" in the file name, OR contain the phrase "bent" in the test comments, AND had "Jeff" as the operator who ran the test.

Figure A59 Estimating the Lash Setting for a Cam Profile

Report Options

Report Specs
 Lobes to Report: Intake & Exhaust
 Type: Seating Velocity
 Report Lift: Yes
 Report Velocity: No
 Report Acceleration: No
 Lift Filtering: Some (but not meas. w elec.)
 Vel/Accel/Jerk Filtering: Heavy
 Cylinders to Report: #1 Only
 Picked Cyls: 1

More Report Options

Custom Duration | Seating Velocity | Checking Limits

First RPM: 7000
 Second RPM: 7250
 Third RPM: 7500

Put asteriks * on Velocities greater than ...: 40

Don Hubbard, in his book 'Camshaft Reference Handbook (c) 1993, gives these conservative suggestions for maximum allowable Seating Velocities:
 25 inch/sec for production and long distance racing engines.
 30 inch/sec for shorter distance (50 miles/100 Km) race engines.
 35 inch/sec drag racing engines.
 Note: As materials improve, these limits are likely to increase.

Lash 1: .004
 Lash 2: .005
 Lash 3: .006
 Lash 4: .008
 Lash 5: .010
 Lash 6: .012
 Lash 7: .015
 Lash 8: .020
 Lash 9: .024
 Lash 10: .028

Estimated Lash on Cam Profile: Yes

Callouts:
 - Choose Seating Velocity for Report Type.
 - Click here to request an estimate of the lash point to be found.
 - Click here to bring up the Options screen above.

Cam Analyzer v4.0 'Plus' Performance Trends [ISK-103.C2]

Report of: Cyl 1, Valve Data Test Time: 4:02 pm 01.31.2009 Events Rated at .05" Tappet Lift

	CLine	Dur	Open	Close	Lb Area	Lb Lift	Vlv Lift	RAR	Lash	LbSep/Adv	Overlap	ASym
Int:	105.1	249.8	19.8	50.1	29.14	.338	.507	1.5	.01	105.4	42.4	.1
Exh:	105.6	255.5	52.8	22.7	30.66	.350	.525	1.5	.01	.3 Advance		.54

Lash	Vel @ 7000 RPM, int	Vel @ 7250 RPM, int	Vel @ 7500 RPM, int	Vel @ 7000 RPM, exh	Vel @ 7250 RPM, exh	Vel @ 7500 RPM, exh
Cyl 1						
.004	12.45	12.90	13.34	10.62	11.00	11.38
.005	14.91	15.45	15.98	11.77	12.19	12.61
.006	17.47	18.09	18.71	12.80	13.25	13.71
.008	22.97	23.79	24.61	14.63	15.15	15.68
.010	28.78	29.81	30.84	16.50	17.09	17.68
.012	34.59	35.83	37.06	19.19	19.87	20.56
.015	42.90 *	44.43 *	45.96 *	26.12	27.06	27.99
.020	55.36 *	57.34 *	59.32 *	42.22 *	43.73 *	45.24 *
.024	64.30 *	66.59 *	68.89 *	54.29 *	56.23 *	58.17 *
.028	72.50 *	75.08 *	77.67 *	65.11 *	67.44 *	69.76 *
Lash/RAR	.0073 Open	.0106 Close	1.50 RAR	.0143 Open	.0163 Close	1.50 RAR

Callouts:
 - Estimated Lash for Exhaust Profile
 - The lash point reported depends on the Rocker Arm Ratio, and that is why it is reported here. If we made this report again with a 1.60 RAR, the Open and Close lash would be different.
 - The program estimates the lash point on the closing ramp for the exhaust profile at .0106" with a 1.5 Rocker Arm Ratio. Finding the lash point is an ESTIMATE. For this Intake profile, the lash point is somewhere in the range of .007" to .010".
 - The program estimates the lash point on the opening ramp for the intake profile at .0073" with a 1.5 Rocker Arm Ratio.

Figure A60 New Preference for Emailing

V4.0 adds several "Method 2" options which add some default Hotmail, Live Mail, AOL, Gmail, and Yahoo accounts. Note: You may have to adjust these defaults for your particular email account.

"Method 1" options work like they did in v3.8 and earlier versions.

Enter the Email Specs used by your email service. For Email Info, you can choose from several Default providers which will fill in SMTP, Port Number and Use Secure Socket Layer, or use "Use Specs Below" to enter most anything you want. Note: The Default specs may not always work for those providers and things change.

To find these settings, you may have to go into your email program and click on things like Properties, Mail Accounts, etc.

To get these settings correct may require some trial and error

Click here to enter your email password. Note that it is NOT stored in an encrypted form

Enter the email address you want emails sent from the Suspension Analyzer to be marked as "From".

Click here for more info on setting up your Emailing Preferences.

Once you have selected your inputs, you can click on this button to send a trial email to see if any errors occur.

Some email options let you print to a PDF printer and then email the PDF file. This input lets you select which PDF printer you want to use if more than one is available on your computer.

Click on the Find button to find the path to the Windows Accessory "MSPaint.exe". This path is only used if you want to send a graph in the faster, smaller file size of 16 bit color.

Figure A61 Importing File for Just 1 Lobe, to Combine with Existing Cam File

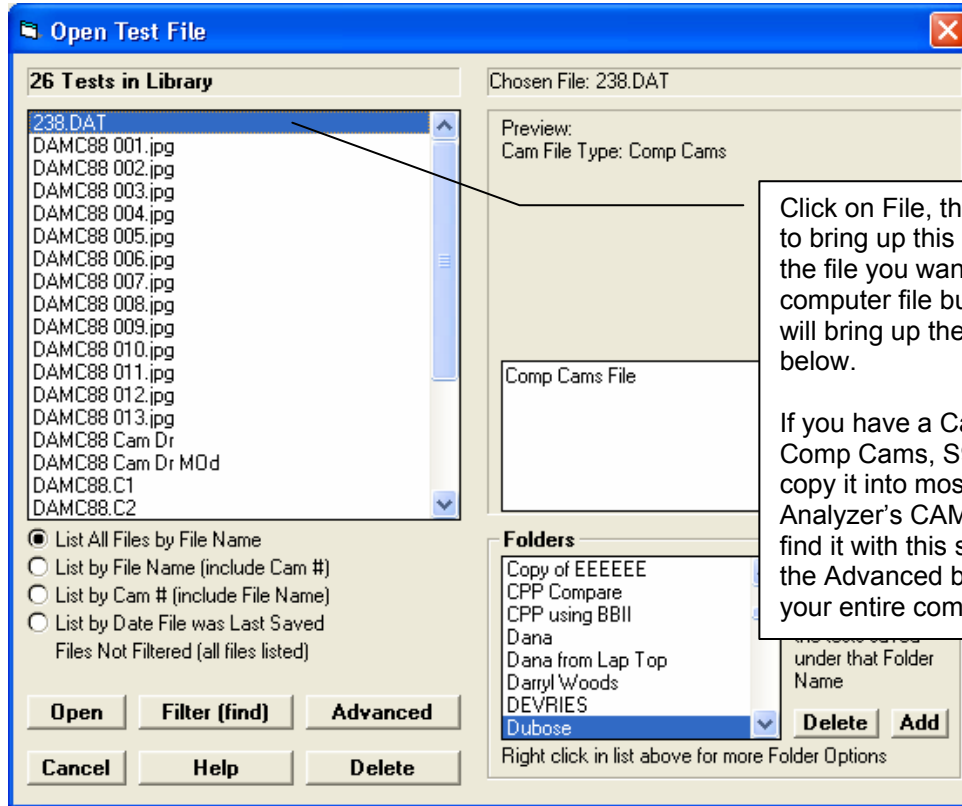

Click on File, then Open (from all saved tests) to bring up this screen. From here click on the file you want to open. If this file is a computer file but not a Cam Analyzer file, you will bring up the Cam File Options screen below.

If you have a Cam File (like a Cam Pro Plus, Comp Cams, S96, Andrews, etc), you can copy it into most any folder under the Cam Analyzer's CAMDATA folder. Then you can find it with this screen. You can also click on the Advanced button to lower left and browse your entire computer.

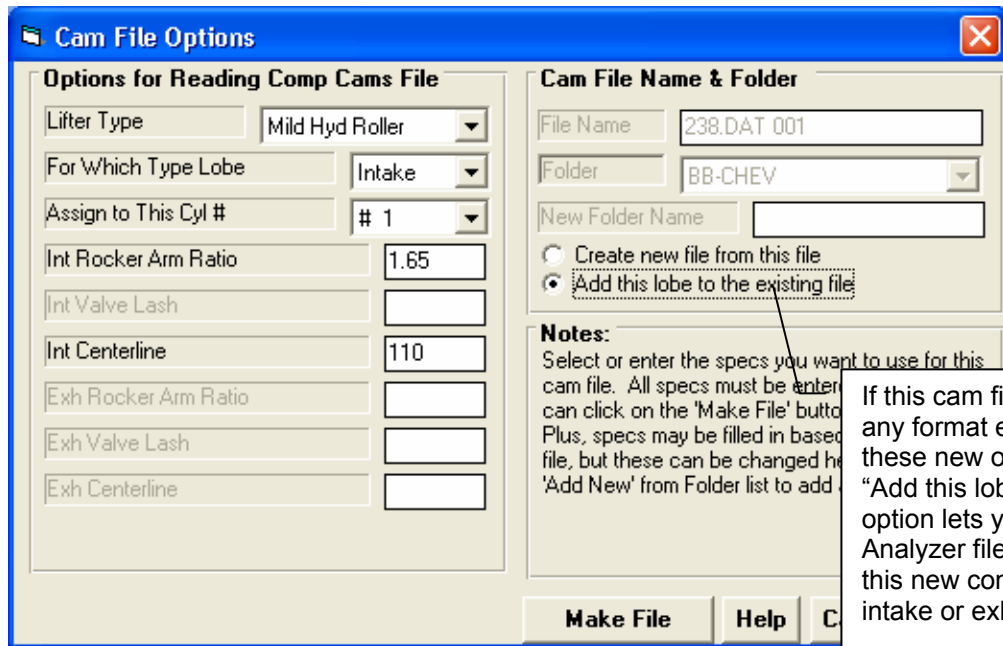

If this cam file has only one lobe (most any format except a Cam Dr file), these new options will appear. The "Add this lobe to the existing file" option lets you keep you existing Cam Analyzer file, but just add the lobe from this new computer file to either the intake or exhaust lobe.

Appendix 7: FFT Analysis in v4.0

The Cam Grinder version of the program now allows you to pick various data types to graph. These include:

- Lift Frequency Analysis *
- Acceleration Frequency Analysis *
- Jerk Frequency Analysis *

This Frequency Analysis is performed by doing a FFT (Fast Fourier Transformation) on the Lift, Acceleration or Jerk curves. The theory behind Fourier Transformation is that *any* repetitive wave form can be represented by some combination of mathematical sine waves. The repetitive wave form for cam analysis is the cam lift curve occurs every 360 degrees of camshaft rotation. FFT is a mathematical method to determine what major frequency components (sine waves) make the cam lift profile.

Cam analysis work has been done to determine that if major frequencies in the *Valve Acceleration* curve exist at low enough frequencies, and if these frequencies match up to the natural frequency of the valve spring, spring surge problems can occur. Think of an “out of balance” tire on your car. If you drive at 60 MPH, you may not notice the imbalance at all, but drive at 70 and you can barely hold on to the steering wheel. At 70 MPH you have hit one of the natural frequencies of the suspension system, which is being excited by the natural frequency of the tire. At 60 MPH, the frequency may be 5.4 Hz and 70 MPH may be 6.3 Hz (cycles per second) depending on tire size.

The same is true of the valve train. If the natural frequency of the primary valve spring is 300 Hz and a large frequency component of the valve acceleration profile match up, then spring surge may occur. When this occurs, just like the steering wheel wants to jump out of your hand, the valve spring and valve train are very hard to control. If possibly, you want to avoid RPMs which produce acceleration frequencies which are close to the natural frequency of the valve spring.

Don Hubbard, previously of Crane Cams, in his outstanding book “Camshaft Reference Handbook” has developed some limits which should be avoided for various valve train design. These are:

Limit	Valve Train Type
.22	Direct acting OHC (overhead cam) buckets valve trains
.18	OHC rocker arm valve trains
.12	Pushrod/rocker arm valve trains

The program offers to do FFT analysis of the Lift and Jerk data as well. However, we don’t know of any limits which have been developed for FFT analysis of these curves. You should get a copy of Don’s book for more details.

The procedure to do this analysis are outlined in Figure A62, and include:

- Obtain a cam file and convert to “Measured with Electronics”. If you measure with our Cam Test Stand, this happens automatically.
- Enter data for the Primary Valve Springs, which is typically the largest spring (outer spring) in a valve spring pack via the Cam/Test Setup screen.
- Set a description for the Valve Train Type in the Primary Valve Spring screens also.
- Request the Valve Accel Frequencies Data Type and set Graph vs Nat. Freq. RPM to Yes.
- Make a graph and find the lowest frequency RPM which goes above the limit set for the valve train type. The frequency RPM below this is the safe RPM limit for this particular valve lift profile with these valve springs.

IMPORTANT: This analysis is done on the Valve Acceleration curve. Therefore it will change depending on the Rocker Arm Ratio and Lash you enter into the Cam/Test Setup screen.

Figure A62 "Cam Grinder" FFT Analysis (also Fig A52)

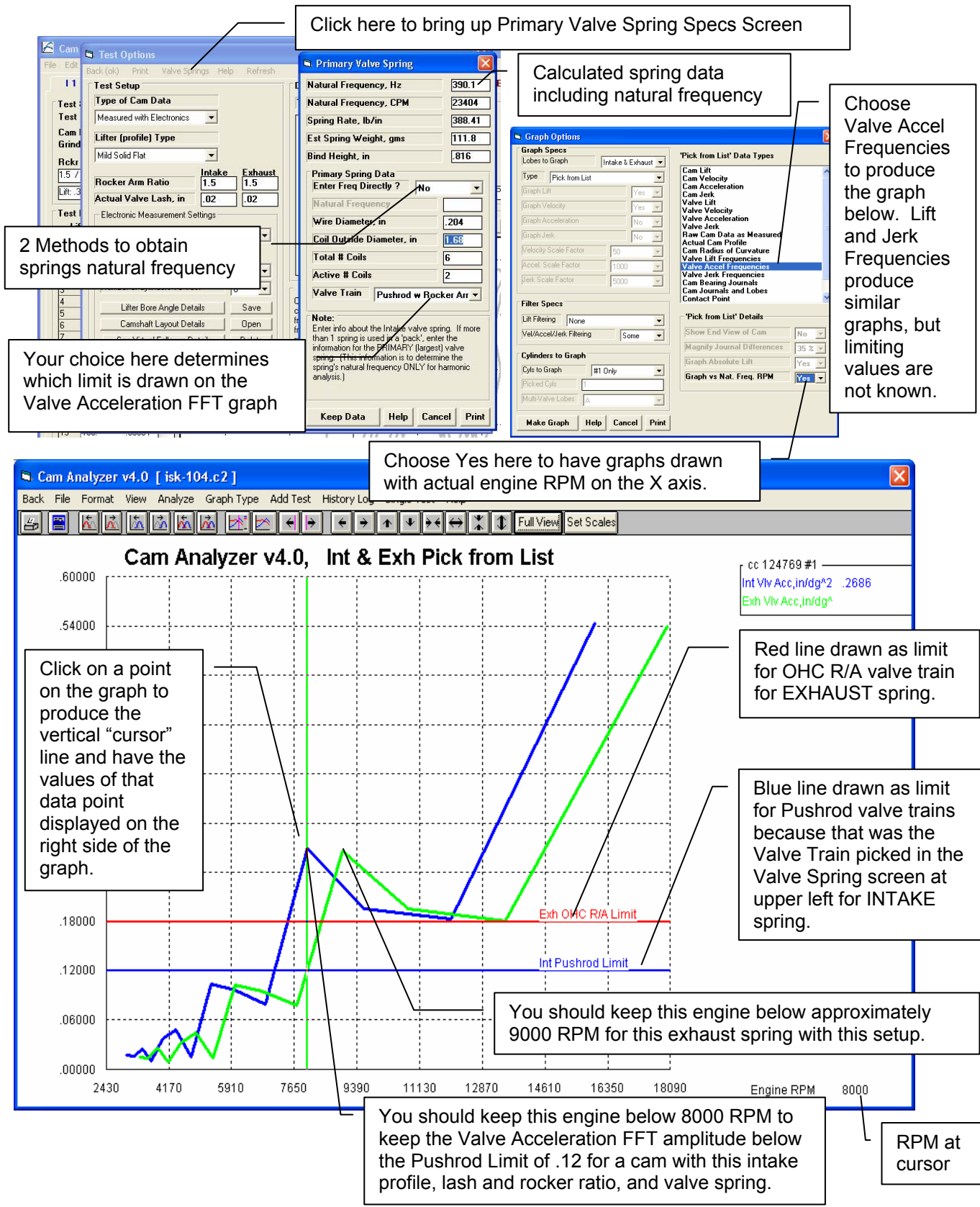

Click here to bring up Primary Valve Spring Specs Screen

Calculated spring data including natural frequency

Choose Valve Accel Frequencies to produce the graph below. Lift and Jerk Frequencies produce similar graphs, but limiting values are not known.

2 Methods to obtain springs natural frequency

Your choice here determines which limit is drawn on the Valve Acceleration FFT graph

Choose Yes here to have graphs drawn with actual engine RPM on the X axis.

Click on a point on the graph to produce the vertical "cursor" line and have the values of that data point displayed on the right side of the graph.

Red line drawn as limit for OHC R/A valve train for EXHAUST spring.

Blue line drawn as limit for Pushrod valve trains because that was the Valve Train picked in the Valve Spring screen at upper left for INTAKE spring.

You should keep this engine below approximately 9000 RPM for this exhaust spring with this setup.

You should keep this engine below 8000 RPM to keep the Valve Acceleration FFT amplitude below the Pushrod Limit of .12 for a cam with this intake profile, lash and rocker ratio, and valve spring.

RPM at cursor

Appendix 8 Filter Test Files (Plus Version Only)

The v4.0 Cam Analyzer has a powerful way to search for tests in the Test Library called the Filter Option. Click on the Filter button in the Open Test File menu (Figure A58) to be presented with the screen shown below.

Figure A63 Filter Files Menu

Click on the down arrow button to pick the spec or comment to check for a certain condition "Has this relationship".

Click on the down arrow button to pick the condition to look for. These change depending on the spec or comment you have chosen.

Type in (or pick from a list for some specs) the condition to look for. The program treats UPPER and lower case letters the same (bowtie = BOWTIE = BowTie).

Check here to include a 2nd condition. This enables specs in this section.

Click on this button to return to the File Open menu which will now show **all test files**.

Click on this button to return to the File Open menu which will now **only show files which fit the Filter Conditions**.

Select And and the Test Files displayed must fit **both** conditions specified. Select Or and the Test Files displayed can fit **either** of the conditions specified.

These options let you choose which folders to search, All Folders or just the ones you have selected in the list.

Click here to produce a report of all files meeting the Filter conditions IN ALL FOLDERS in the CAMDATA folder (the entire Test Library). This way you can avoid looking in each folder separately and can save time.

The settings in this screen will display all test files with the word BowTie (or bowtie or BOWTIE) somewhere in the test comments and with a Dry Density Altitude between 1000 and 4000 ft (calculated from weather info in the Track Conds menu).

The Filter Feature is very useful for finding a specific test or to find all the tests which meet a certain set of conditions. For example, say you want to find a test that Operator “Jack” ran for Customer “Smith” on a “Big Block Chevy” cam. Or, say you want to check on all tests run with 1.5 intake rocker arms, where “1.5” would be in the “Intake Rocker Arm” field in the Test Conditions screen. Or perhaps you want to find all Crower cams that “Jeff” measured . In all these cases, the filtering specs would allow you to find the test files.

First you must select the condition you want to look for by clicking on the down arrow button on the 'This comment or spec' box. Your choice of this spec will determine what the 'Has this relationship' options are, and what specs can be entered in the 'To what I enter here' spec.

You can select up to 3 conditions to look for. For the Operator “Jack”, Customer “Johnson”, “Big Block Chevy” example above, you would need to search for 3 conditions. For the “1.5” intake rocker arm example, you could just search for 1 condition. You add conditions by checking the 'Include this condition also' box. This enables the other specs for each condition.

If more than 1 condition is being used for the search, you must determine if you want the search to include tests which fit ANY of the conditions (Or) or must match ALL conditions (And). For example, if you are looking for tests run by either Operator Jack or Operator Joe, you would select “Or”. If you want Tests which made more than 1.5 intake rocker arm ratio *and* were done since Jan 2012 (the tests must match both conditions), you would select “And”.

The 3 command buttons will do the following:

Show Files Only Fitting These Conditions will return you to the Open Test File screen. Only files fitting these conditions will be displayed (which may be no files in some situations). You can click on various folders (or whatever name you have given to folders in the Preferences menu at the Main Screen) to see if there are any matches in other folders.

Turn Off Filtering (show all files) will return you to the Open Test File screen and now all files will be displayed.

Print List of All Files Fitting These Conditions will search through the entire Test Library (all folders in the CAMDATA folder) for files matching these conditions and display them in a new screen. From this screen, you can also print the list. This is the quickest way to see which folders may contain test files matching your conditions.

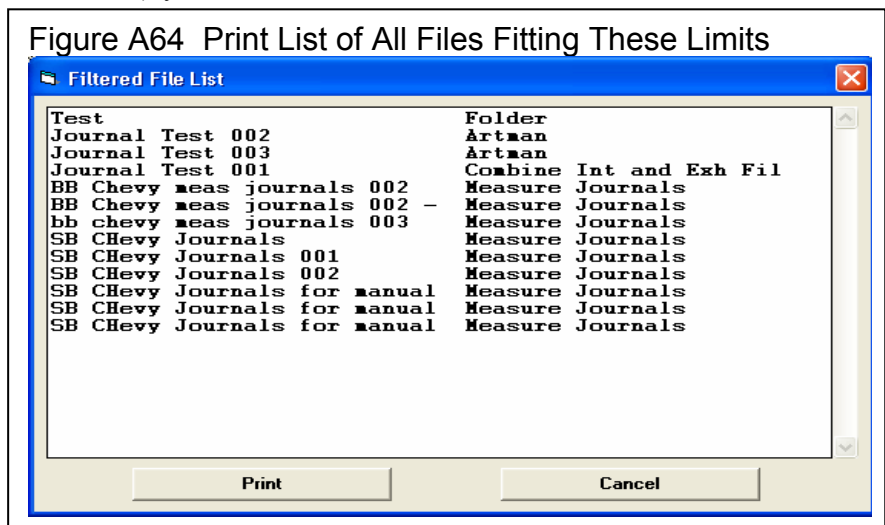

Figure A64 Print List of All Files Fitting These Limits

Tip: When looking for a word, the program doesn't care if it is in CAPITAL (upper case) or small (lower case) letters. In Figure A64 above you are looking for the word BowTie in the test comments. The program will display all files which have the word “BowTie” or the word “BOWTIE” or the word “bowtie” or the word “BowTIE” anywhere in the comments. The program will *not* find files with the words “Bow Tie” (with a space between Bow and Tie) . Therefore, it may be smarter to just look for the word “bow” to avoid this problem. Note, however, that if you do this, the program will also find tests with the word “elbow” or “crossbow” , for example, in the test comments.

Index

- 2, 140, 141
- Absolute Lift, 159
- Acceleration, 27, 41, 42, 43, 44, 52, 53, 54, 55, 88, 97, 98, 101, 103, 122, 124, 181
- Accuracy, 7, 1, 3, 78, 99, 103, 135, 141
- Accurate, 21, 35, 38, 44, 55, 78, 83, 85, 90, 99, 100, 116, 122, 123, 135, 139, 140
- Accurately, 27, 30, 31, 38, 42, 54, 85, 91, 100, 101, 116, 117
- Actual Cam Profile, 159, 161
- Actual Valve Lash, 23, 128
- Advanced, 14, 70, 71, 73, 75, 160
- Allow Direct Entry of Cam Numbers, 14, 20, 36
- Allow Not Smoothing Cam File, 20, 78
- Alternate Lifts for Reports, 19
- Graph, 139
- Andrews, 21, 71, 138
- Angle and Distance, 141
- ASCII File Options, 49
- Assumes, 22, 24, 100, 118, 161
- Assumptions, 7, 3, 99
- Asymmetry, 138, 139, 161
- Audie Technology, 141
- Backing Up Data, 7, 107
- Backup, 14, 99, 107, 109, 110, 138
- Base Circle, 23, 24, 33, 86, 121, 122, 124, 140, 141, 159
- BDC, 25, 33, 42, 82
- Black Box, 117, 118, 121, 122, 134, 135, 139, 141
- Bore, 129
- CA20, 2, 14, 69, 107, 109
- Calculation Menu, 141
- Calibration, 141
- Cam, 1, 3, 4, 6, 7, 1, 2, 3, 4, 5, 6, 7, 9, 10, 13, 14, 15, 16, 17, 18, 19, 20, 21, 22, 23, 24, 25, 27, 33, 35, 36, 37, 38, 39, 41, 42, 43, 44, 45, 46, 49, 52, 53, 54, 55, 56, 62, 63, 64, 67, 68, 69, 71, 72, 73, 75, 76, 77, 78, 81, 82, 83, 84, 85, 86, 87, 88, 89, 90, 91, 92, 93, 94, 95, 96, 97, 98, 99, 100, 101, 102, 103, 104, 105, 107, 109, 110, 111, 116, 117, 118, 120, 121, 122, 123, 124, 126, 127, 128, 129, 130, 132, 133, 134, 135, 137, 138, 139, 140, 141, 159, 160, 161, 162, 181, 183, 184
- Cam Analyzer, 1, 4, 1, 2, 4, 5, 9, 20, 21, 27, 39, 49, 62, 63, 67, 68, 69, 71, 72, 73, 77, 78, 81, 84, 85, 88, 91, 92, 99, 100, 101, 103, 109, 129, 135, 137, 138, 139, 141, 159, 183
- Cam Card, 139, 160, 161
- Report, 139
- Report, 160
- Report, 161
- Cam Design, 120, 128, 129, 130, 140
- Cam Dr, 3, 6, 1, 17, 20, 21, 25, 42, 43, 49, 53, 54, 55, 68, 71, 72, 77, 78, 83, 101, 103, 104, 118, 137, 138, 161
- Cam Grinder, 91, 159, 160, 161, 162, 181
- Cam Number, 14, 20, 36, 63, 83
- Cam Pro, 3, 1, 21, 25, 49, 68, 71, 100, 101, 103, 105, 111, 138, 139, 141, 161
- Cam Pro Plus™, 141
- Cam Test Stand, 7, 1, 27, 117, 118, 122, 127, 137, 139, 140, 159, 181
- Cam Timing Value, 120, 127, 128
- CamData, 9, 20, 36, 69, 71, 73, 75, 83, 107, 109, 184
- Camshaft, 118, 120, 122, 127, 129, 133, 134, 140, 181
- Camshaft Reference Handbook, 139, 181
- Centerline, 23, 25, 72, 128, 135, 139
- Report, 139
- Checking Limits Report, 139
- Clc Button, 141
- Clipboard, 111, 137
- Com Port, 118, 135, 141
- Comma Separated, 49
- Comment, 29, 63, 64
- Comp Cam, 21, 71, 97, 111, 137, 161
- Company Logo, 138, 160, 161
- Compare Measurement Comments, 123
- Reports, 139
- Comparison Reports, 139
- Compression, 141
- Contact Point, 139, 159
- Convert to Columns, 49
- Copy, 68, 69, 71, 107, 109, 111, 137, 160, 181
- Current Test, 9, 76, 81
- Cursor, 57, 59, 98
- Report, 139
- Custom Duration Report, 139
- Customer, 14, 15
- Cut and Append, 160
- Date, 14, 36, 83, 107, 109, 160
- Default, 17, 19, 35, 77, 82, 137, 138, 140, 141
- Default Floppy Disk XE "Disk" Drive, 19
- Deg Steps, 21, 22, 33, 88, 99, 100, 101, 102, 103
- Degree Wheel, 6, 13, 15, 16, 25, 33, 42, 82, 83, 85, 86, 87, 91, 99, 100
- Degree Wheel Type, 6, 25, 82, 86
- Delete, 14, 15, 68, 75, 87, 91
- Designed Valve Lash, 23, 24
- Disk, 19, 73, 109
- Don Hubbard, 139, 181
- Dr Doctor, 21, 71
- Duration, 1, 2, 21, 22, 23, 27, 33, 41, 45, 46, 64, 81, 82, 83, 86, 87, 89, 90, 91, 94, 98, 99, 103, 122, 135, 137, 139, 140, 161
- Duration Report, 41, 89, 90, 94
- Edit, 6, 14, 15, 57, 60, 76, 87, 91, 111, 137, 138, 160, 162
- Edit, Cut and Append, 160

Electronic Sensors, 1, 128, 137, 141, 159
 Email, 1, 3, 137, 161
 Encoder, 118, 121, 122, 133, 138, 139, 140, 159, 160
 Encoders, 122, 133, 140
 Engine Analyzer Pro, 1, 17, 77, 78, 137
 Error, 31, 89
 Errors, 27, 35, 42, 43, 45, 53, 55, 84, 85, 86, 87, 88, 90, 100, 101, 116, 122, 124, 159
 Excel, 160
 Explorer, Windows, 2, 69, 73, 107, 108, 109, 110
 Export, 42, 73, 111, 137, 160
 EZ Data Entry, 6, 37, 87, 91, 137
 EZ Start Wizard, 4, 137
 FFT, 7, 160, 181
 File, 1, 2, 4, 6, 10, 14, 15, 16, 17, 21, 22, 25, 27, 29, 35, 42, 43, 49, 50, 53, 54, 55, 56, 68, 70, 71, 72, 73, 75, 76, 77, 78, 81, 82, 83, 84, 85, 88, 93, 98, 100, 109, 110, 111, 118, 137, 138, 139, 159, 160, 161, 181
 File Destination Path, 77
 File Name, 35, 49, 72, 75, 77, 82, 90
 Files, manufacturing, 160
 Files, P File, 160
 Files, X,Y Data, 160
 Filter, 7, 42, 43, 44, 52, 53, 54, 55, 78, 88, 92, 100, 101, 183, 184
 Filter, files, 7, 42, 43, 44, 53, 54, 55, 97, 98, 100, 160, 183, 184
 Find Difference Between Lobes, 139
 Find TDC, 6, 1, 27, 83, 84, 91
 Firing Order, 132
 First Degree Wheel Reading, 33, 86
 Floppy Drive, 17, 109
 Folders, 20
 Follower, 16, 82, 122, 124, 137, 138, 140, 159, 160
 For Cyl #, 22, 128
 Frequency Analysis, 159, 160, 181
 Frequency, natural, 160, 181
 Gaps, 124
 Generate, 6, 1, 4, 15, 21, 23, 33, 85, 86, 87, 91, 160
 Graph, 1, 6, 10, 15, 17, 20, 44, 49, 51, 52, 55, 56, 57, 58, 59, 60, 61, 62, 75, 76, 87, 88, 89, 91, 95, 96, 97, 98, 101, 103, 104, 111, 118, 123, 124, 126, 138, 139, 159, 160, 161, 162, 181
 Graph XE "Graph" Dot Matrix Printer XE "Printer" Adjustment, 20
 Graph Format, 138
 Graph Line Colors, 138
 Graph Type, 6, 52, 97
 Graphs, 6, 51, 56, 57, 62, 92, 96, 97, 100, 138
 Grid, 45
 Heavy, 43, 44, 55, 160
 Help, 2, 3, 4, 6, 7, 15, 18, 35, 38, 82, 111, 120, 161
 High Accels, 124, 135
 History Log, 6, 1, 16, 20, 39, 56, 65, 68, 75, 76, 95, 126
 HP, 24
 Import, 1, 39, 137, 138, 160, 161
 inches/cam degree, 41, 52
 Include .MSU and .DES Files, 78
 Include Text, 49
 Install, 4, 14, 17, 18, 21, 28, 29, 33, 35, 41, 52, 57, 72, 82, 84, 85, 99, 107, 111, 127, 137, 138, 140, 160, 181
 Int & Exh Duration, 45, 46
 Int & Exh Lobe Area, 46
 Int & Exh Raw Data, 45, 107
 Intake Duration, 89
 Journals, 133, 159
 Just show data for Actual Lobe, 140, 141
 Keep Orig File's Lobe Separation, 25
 knife edge, 159, 160
 Lash, 7, 14, 19, 22, 23, 24, 41, 44, 45, 52, 71, 72, 128, 139, 161, 181
 Layout, 122, 128, 132, 133, 134, 140, 141, 161
 Legend, 57, 60, 76, 97, 124
 Library, 9, 10, 14, 16, 22, 56, 67, 68, 75, 107, 109, 183, 184
 Lift, 7, 1, 2, 6, 10, 15, 16, 19, 20, 21, 22, 23, 24, 27, 33, 37, 38, 41, 42, 43, 44, 45, 46, 52, 53, 54, 55, 56, 78, 81, 83, 84, 85, 86, 87, 88, 89, 91, 92, 94, 95, 96, 98, 99, 100, 101, 102, 103, 104, 105, 111, 121, 122, 124, 128, 135, 137, 139, 140, 141, 159, 160, 161, 181
 Lift Filtering, 42, 43, 53, 54, 161
 Lift for Rating Events, 23
 Lift Measurement, 7, 81
 Lifter, 16, 22, 23, 71, 82, 85, 86, 87, 91, 99, 100, 121, 122, 128, 129, 130, 132, 140, 159
 Lifter (profile) Type, 22, 23, 128
 Lifter Bore Angle, 128, 129, 130, 132, 140
 Line colors, 138
 List by Date File was Last Saved, 161
 Report, 139
 Lobe Analysis Report, 139
 Lobe Area, 2, 46, 47, 94, 98, 99, 101
 Lobe Center, 25
 lobe centerline, 84, 92, 135
 Lobe Description, 133
 lobe separation, 72, 81, 82, 89, 135, 139
 Lobe Separation, 25, 72, 91
 Main Screen, 6, 2, 4, 5, 6, 9, 10, 13, 14, 16, 17, 18, 19, 20, 35, 36, 38, 41, 42, 49, 51, 56, 68, 71, 75, 77, 83, 84, 85, 86, 88, 89, 90, 91, 93, 109, 111, 127, 133, 184
 Main Screen Graph Lines, 20
 Max Error, 124
 Max Gaps, 123
 Max Lobe Lift, 22, 24
 Measured with Electronics, 127, 137, 138, 160, 161, 181
 Method to Determine TDC, 84
 Metric, 111, 137, 140
 Millimeters, 111, 137, 140
 Mirror Image, 137
 Moderate, 43, 44, 55, 97, 98
 More (advanced) Options, 140
 Multiply Vel/Accel/Jerk by 1000, 41
 New (start new test), 16, 120
 New Test, 6, 14, 15, 16, 33, 35, 36, 81, 82, 83, 91, 120, 121, 127
 Offset Firing, 132, 133

- Open, 6, 9, 16, 17, 19, 35, 67, 68, 70, 71, 75, 89, 93, 95, 109, 111, 118, 138, 183, 184
- Open XE "Open" (from all saved tests), 16, 71, 93
- Open XE "Open" (from History Log XE "History Log"), 16, 68
- Open/Save/Edit, 138
- Operator, 6, 14, 29, 35, 63, 82, 184
- Order number, 160
- overlap, 83
- Overlap, 94
- PDF, 111, 137, 138
- Performance Trends, 1, 3, 1, 2, 3, 4, 5, 9, 17, 36, 77, 83, 128, 129, 130, 139, 140, 141
- PERFTRNS.PTI, 2, 69, 107, 109
- Plus Version, 3, 7, 1, 25, 49, 68, 111, 137, 138, 139, 140, 159, 160, 161, 162, 183
- Point, 15, 38, 87, 88, 91
- Pointer, 28, 29, 30, 33, 84, 89, 99, 124, 159, 160, 161
- Polar, 160
- Preferences, 6, 9, 14, 18, 19, 36, 45, 64, 75, 78, 83, 118, 122, 134, 137, 161, 184
- Printed Graph Width, % of Page, 20
- Printer, 6, 17, 19, 20, 39, 57, 63, 64, 138
- Printer XE "Printer" Fonts, 19, 64
- Probe, 85, 100, 160
- Program Title Comments, 19
- Radius of Curvature, 159
- Raw Cam Data, 159
- Rckr Ratio/Lash, 14
- Readme, 2
- registered, 3, 4
- Report Data Every, 42
- Report Type, 41, 44, 138, 139
- Restore, 107, 109, 110, 138
- Rocker Arm, 14, 19, 22, 23, 24, 41, 44, 45, 52, 72, 85, 128, 138, 139, 181, 184
- Rocker Arm Ratio, 22, 23, 24, 41, 44, 52, 72, 128, 181
- Rotary, 118, 122, 140
- Runout, 141
- S96, 21, 71, 72, 137, 161
- Save, 1, 6, 7, 9, 16, 17, 19, 35, 37, 38, 49, 67, 68, 70, 73, 75, 76, 87, 90, 91, 118, 138, 139, 161
- Scales, 61
- Scaling, 41, 42
- Report, 139
- Seating Velocity, 139
- Seating Velocity, 161
- Seating Velocity Report, 139
- Select Method to Determine TDC, 27
- Sensors, 137, 141, 159
- Setup, 4, 17, 18, 21, 33, 35, 41, 52, 57, 72, 82, 85, 107, 111, 127, 137, 138, 140, 160, 181
- Shift, 62
- Show All data measured, 140, 141
- Smooth the Cam Data, 78
- Some, 4, 9, 20, 42, 43, 44, 53, 54, 55, 78, 85, 111, 122, 160, 161
- Spring, valve, 160, 181
- Summary Graph, 15, 16, 51, 86
- Tabs, 13
- Tappet, 1, 22, 23, 24, 46, 85, 86, 98, 99, 100, 139, 140, 159
- Tappet Lift, 16, 23, 24, 111, 160
- TDC, 7, 25, 27, 28, 29, 30, 31, 33, 42, 81, 82, 83, 84, 85, 89, 99, 120, 127, 128, 139, 140
- TDC Method, 120, 127, 128
- Test Data Grid, 13, 15, 16, 81
- Test Folder XE "Folders" Name in Program, 20
- Test Operator, 14
- Test Setup and Cam Specs, 6, 7, 11, 14, 15, 16, 18, 21, 44, 67, 81
- Test Stand, 137
- test time, 14
- Thrust Angle, 159
- Time/Date, 36, 83
- Torque, 3, 24, 122
- Total Cam Advance, 22, 24, 72
- Troubleshooting, 135
- Type of Cam Data, 21, 127
- Use Standard Lifts for Reports, 19
- User Finds TDC, 139, 140
- valve lift, 7, 19, 21, 22, 24, 45, 52, 128, 181
- Valve Spring, 160, 181
- Valve Train Layout, 141
- Vel/Accel/Jerk Filtering, 43, 44, 55, 97
- Velocity, 27, 41, 42, 43, 44, 52, 53, 54, 55, 62, 88, 98, 139, 161
- Version 4.0, 7, 1, 159
- Virtual Follower, 137, 138, 139, 140, 160
- Watch Cam/Follower, 139
- Windows, 1, 3, 1, 2, 17, 20, 57, 68, 69, 73, 81, 100, 107, 108, 109, 110, 137, 138, 159
- Wizard, 4, 137
- worksheet, 17, 64
- Zero Lift, 140, 141
- Zoom, 96, 98